



Toshiba air conditioner

# Owner's Manual

Indoor unit

RAS-M10PKVPG-E  
RAS-M13PKVPG-E  
RAS-M16PKVPG-E

- Thank you for purchasing the Toshiba room air conditioner.
- To use the product safely and correctly, please read this manual carefully before use.
- Please keep this manual in a convenient location for future reference.



1121450199

# Contents



<b>Safety Precautions</b>	page <b>4</b>
Follow These Instructions Carefully .....	4
<b>Parts</b>	page <b>7</b>
Indoor unit .....	7
Outdoor unit .....	8
Accessories (Attaching and detaching remote control holder) .....	8
Remote control .....	9
<b>Preparation before operating the air conditioner</b>	page <b>11</b>
Insert the battery .....	11
Setting the clock .....	11
Check transmitting and receiving .....	12
<b>Hi-POWER operation</b>	page <b>13</b>
<b>Automatic operation</b>	page <b>14</b>
<b>Cooling, Heating, Dry operation and Fan only operation</b>	page <b>15</b>
<b>Plasma purifier</b>	page <b>17</b>
<b>Air volume, Air direction and Swing louvers</b>	page <b>18</b>
Changing the air volume .....	18
Changing the air direction .....	18
Swing louvers operation .....	18
Movement of vertical air direction louvers .....	18
<b>Comfort air flow</b>	page <b>19</b>
Wide air flow, Spot air flow .....	19
<b>Timer operation</b>	page <b>20</b>
Comfort sleep .....	20
Timer on, Timer off .....	21

<b>Weekly timer operation</b>	page <b>22</b>
Examples of WEEKLY TIMER uses.....	22
How to set WEEKLY TIMER.....	23
Edit Weekly timer program.....	25
Deactivating WEEKLY TIMER operation.....	25
To delete programs.....	26
<b>WEEKLY TIMER usage example</b>	page <b>27</b>
<b>Set preferred operation</b>	page <b>30</b>
PRESET operation.....	30
<b>Energy Saving</b>	page <b>31</b>
ECO operation.....	31
<b>Limit maximum : Electric Power consumption and Silent Operation (Outdoor Unit)</b>	page <b>32</b>
Power-Selection.....	32
Silent operation (Outdoor Unit) .....	32
<b>Fireplace and 8°C Heating Operation</b>	page <b>33</b>
Fireplace Operation.....	33
8°C Heating Operation .....	33
<b>Operation of display lamp brightness adjustment</b>	page <b>34</b>
<b>Inside drying operation</b>	page <b>35</b>
<b>Care and cleaning</b>	page <b>36</b>
Inspect air conditioner regularly to ensure efficient operation.....	36
Not in use for an extended period.....	37
Re-starting after extended off period.....	37
Regular check.....	37

<b>When indoor unit lamp blinks</b>	page <b>38</b>
<b>Auto Restart</b>	page <b>39</b>
<b>Special points to consider</b>	page <b>40</b>
If the remote control is not available.....	40
In the event 2 air conditioners are installed in close proximity.....	40
Concern about the operating noise.....	40
<b>These are not failures</b>	page <b>41</b>
Operation and behavior of the air conditioner.....	41
Appearance of vapor or condensation .....	41
Odor or dirt.....	41
Operation lamp.....	42
Remote control operation.....	42
If a noise is heard.....	42

# Safety Precautions

**Follow These Instructions Carefully**



Read the precautions in this manual carefully before operating the unit.



This appliance is filled with R32.

- Keep this manual where the operator can easily find it.
- Read the precautions in this manual carefully before operating the unit.
- This appliance is intended to be used by expert or trained users in shops, in light industry and on farms, or for commercial use by lay persons.
- The precautions described herein are classified as DANGER, WARNING and CAUTION. They both contain important information regarding safety. Be sure to observe all precautions without fail.

## **DANGER**

- Do not install, repair, open or remove the cover. It may expose you to dangerous voltages. Ask the dealership or the specialist to do this.
- Turning off the power supply will not prevent potential electric shock.
- The appliance shall be installed in accordance with national wiring regulations.
- There must be incorporated in the fixed wiring and the means of disconnecting a contact separation of at least 3 mm in all poles.

## **WARNING**

- Do not expose your body directly to cool or warm air for a long time.
- Do not insert your finger or any article into the air inlet/outlet.
- When an abnormality (burning smell, etc.) occurs, stop the air conditioner and turn off the circuit breaker.
- Installation must be requested from the supplying retail dealership or professional installation vendors. Installation requires special knowledge and skill. Customer installation can cause fire, electric shock, injury or water leakage.
- Do not select a location for installation where flammable gas may leak. If there is any gas leakage or accumulation around the unit, it can be a cause of fire.
- Do not turn ON/OFF the circuit breaker or operate buttons with a wet hand. It may be a cause of electric shock.
- Do not disassemble, modify or relocate the unit by yourself. It may become the cause of fire, electric shock, or water leakage. For repair or relocation, please request service from the supplying retail dealership or a Toshiba dealership.

- Do not select a location for installation where there may be excessive water or humidity, such as a bathroom. Deterioration of insulation may be a cause of electric shock or fire.
- When relocating or repairing the unit, please contact the supplying retail dealership. A kink in the wiring may cause electric shock or fire.
- During a malfunction, (such as a burning odor or not cooling), stop operating the unit and turn off the circuit breaker. Continuous operation may be a cause of fire, or electric shock. Please request repair or service from the supplying retail dealership or a Toshiba dealership.
- Grounding should be requested from the supplying retail dealership or professional vendors. Insufficient grounding work may be the cause of electric shock. Do not connect the earth wire to a gas pipe, water pipe, lightning conductor, or telephone earth wire.
- If the indoor unit piping outlet is exposed due to relocation, close the opening. Touching internal electrical parts may cause injury or electric shock.
- Do not insert any material (metal, paper, or water, etc.) into the air outlet or air intake opening. There are high voltage sections or a fan operating at high speed which may cause an injury or electric shock.
- You must use an independent power outlet for the power supply. If a power outlet other than the independent outlet is used, it may cause a fire.
- When the air-conditioning unit does not cool or not warm there may be a leakage of refrigerant. Please consult the supplying retail dealership. The refrigerant used in the air-conditioning unit is safe. It will not leak under normal operating conditions but



if it leaks into the room and contacts a heat source such as a heater, or stove, it may cause a harmful reaction.

- When water or other foreign substances enter the internal parts, stop operating the unit immediately and turn off the circuit breaker. Operating the unit continuously may cause fire or electric shock. Please contact the supplying retail dealership for repair.
- Do not clean the inside of the air-conditioning unit yourself. Please request internal cleaning of the air-conditioning unit from the supplying retail dealership. Incorrect cleaning may cause breakage of resin parts or insulation defects of electrical parts, causing water leakage, electric shock or fire.
- Do not damage or modify the power cable. Do not connect the cable midway, or use a multiple outlet extension cord that is shared by other devices. Failure to observe this precaution may cause a fire.
- Do not place heavy objects on the power cable, expose it to heat, or pull it. Doing so may cause electrical shock or fire.
- This appliance can be used by children aged from 8 years and above and persons with reduced physical, sensory or mental capabilities or lack of experience and knowledge if they have been given supervision or instruction concerning use of the appliance in a safe way and understand the hazards involved. Children shall not play with the appliance. Cleaning and user maintenance shall not be made by children without supervision.
- This appliance is not intended for use by persons (including children) with reduced physical, sensory or mental capabilities, or lack of experience and knowledge, unless they have been given supervision or instruction concerning use of the appliance by a person responsible for their safety.
- Children should be supervised to ensure that they do not play with the appliance.
- Do not use any refrigerant different from the one specified for top-ups or replacement as abnormally high pressure, etc.

Otherwise, abnormally high pressure may be generated in the refrigeration cycle, which may result in a failure or explosion of the product or an injury to your body.

**⚠ CAUTION**

- Check that the circuit breaker is installed correctly. If the circuit breaker is not properly installed, it may cause an electric shock. To check the installation method, please contact the supplying retail dealership or the professional vendor who installed the unit.
- When using the unit in a closed room, or operating with other combustion appliances, make sure to open a window occasionally for ventilation. Insufficient ventilation may cause suffocation due to a lack of oxygen.
- Avoid operating for long periods in a high humidity environment (over 80%) such as with the windows or doors open. There may be condensation on the indoor unit and droplets may fall onto the furniture.
- When the unit won't be used for a long time, turn off the main switch or the circuit breaker.
- It is recommended that maintenance be performed by a specialist when the unit has been operated for a long time.
- At least once a year check if the mounting table of the outdoor unit is damaged or not. If a damaged state is ignored, the unit may fall or over-turn, causing an injury.
- Stand on a sturdy ladder when attaching/detaching the front panel/air filter. Failure to do so may cause a fall or injury.
- Do not stand on the outdoor unit or place anything on the unit. It may be the cause of injury due to falling or over-turning. Any damage to the unit may cause an electric shock or fire.
- Do not use combustion appliances in the direct flow of the air from the air-conditioning unit. Poor combustion of a combustion appliance may cause suffocation.
- Do not place anything around the outdoor unit or allow fallen leaves to accumulate around it. If there are fallen leaves, small animals could enter and contact internal electrical parts, causing a failure or fire.

- Do not place animals and plants in places where wind from the air-conditioning unit flows directly. It may have a negative influence on the animal or plant.
- Ensure that drained water is discharged. When the discharging water process is not sufficient, water may leak, causing water damage to furniture. To check that the installation method used is correct, please contact the supplying retail dealership or the professional vendor who installed the unit.
- Do not place any containers such as a vase containing fluid on the unit. It might cause water to enter the unit and damage the electrical insulation, causing an electric shock.
- Do not use for special applications such as storage of food or animals, or to display plants, precision devices, or art objects. Do not use on ships or in other vehicles. It may cause a failure in the air-conditioning unit. In addition, it may damage these items.
- Do not place other electrical appliances or furniture under the unit. Water droplets might fall, causing damage or failure.
- When cleaning, you must stop operating the unit and turn off the circuit breaker. Since the fan inside may be rotating at high speed, it may cause an injury.
- Do not wash the main air-conditioning unit with water. It may cause an electric shock.
- After the front panel/air filter is cleaned, wipe away any water and allow to dry. If water remains, it may cause an electric shock.
- Once the front panel is removed, do not touch the metal parts of the unit. It may cause an injury.
- Do not touch the air intake section or the aluminum fins of the unit. It may cause injury.
- When you hear thunder and there might be a lightning strike, stop operating the unit and disconnect the circuit breaker. If lightning strikes, it may cause a failure.
- The manufacturer shall not assume any liability for damage caused by not observing the safety information in this manual.
- Batteries for remote control unit:
  - Should be inserted with correct polarity (+) and (-).
  - Should not be recharged.
  - Do not use batteries for which the “Recommended usage period” has expired.
  - Do not keep used batteries inside the remote control unit.
  - Do not mix different types of batteries, or mix new batteries with old ones.
  - Do not directly solder the batteries.
  - Do not short-circuit, disassemble, heat, or throw batteries into a fire. If batteries are not disposed of correctly, they may burst or be the cause of fluid leakage, resulting in burns or injuries. If touching the fluid, wash thoroughly with water. If it touches devices, wipe off to avoid direct contact.
  - Do not place within reach of small children. If a battery is swallowed, consult a doctor immediately.
- The manufacturer shall not assume any liability for damage caused by not observing the safety information in this manual.

# Parts

## Indoor unit

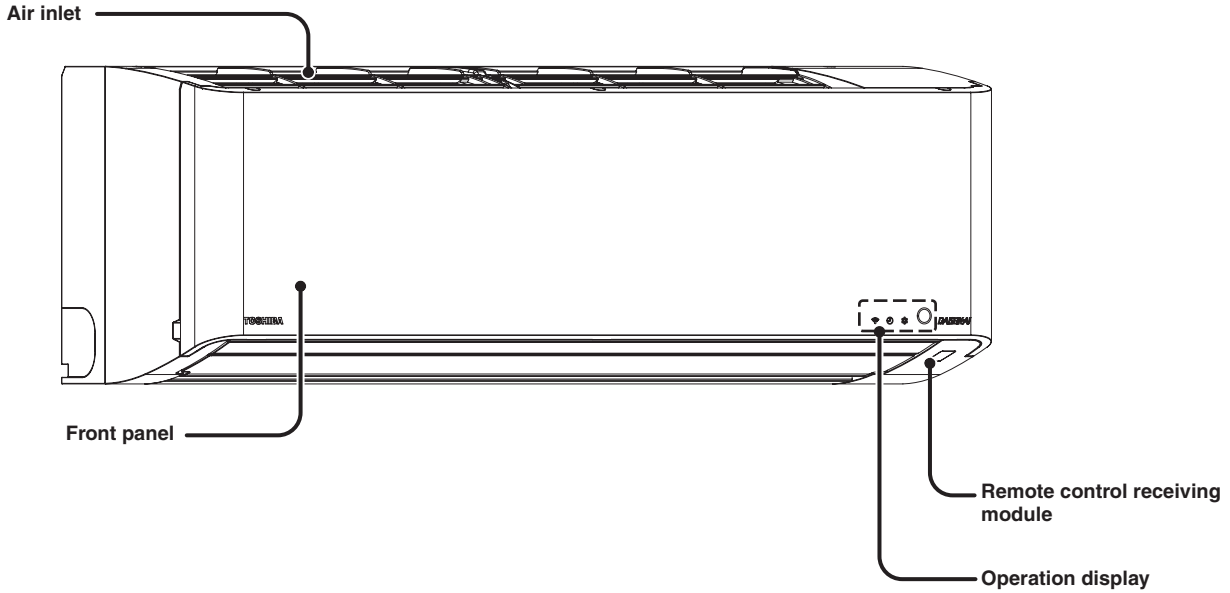

## When the front panel is opened

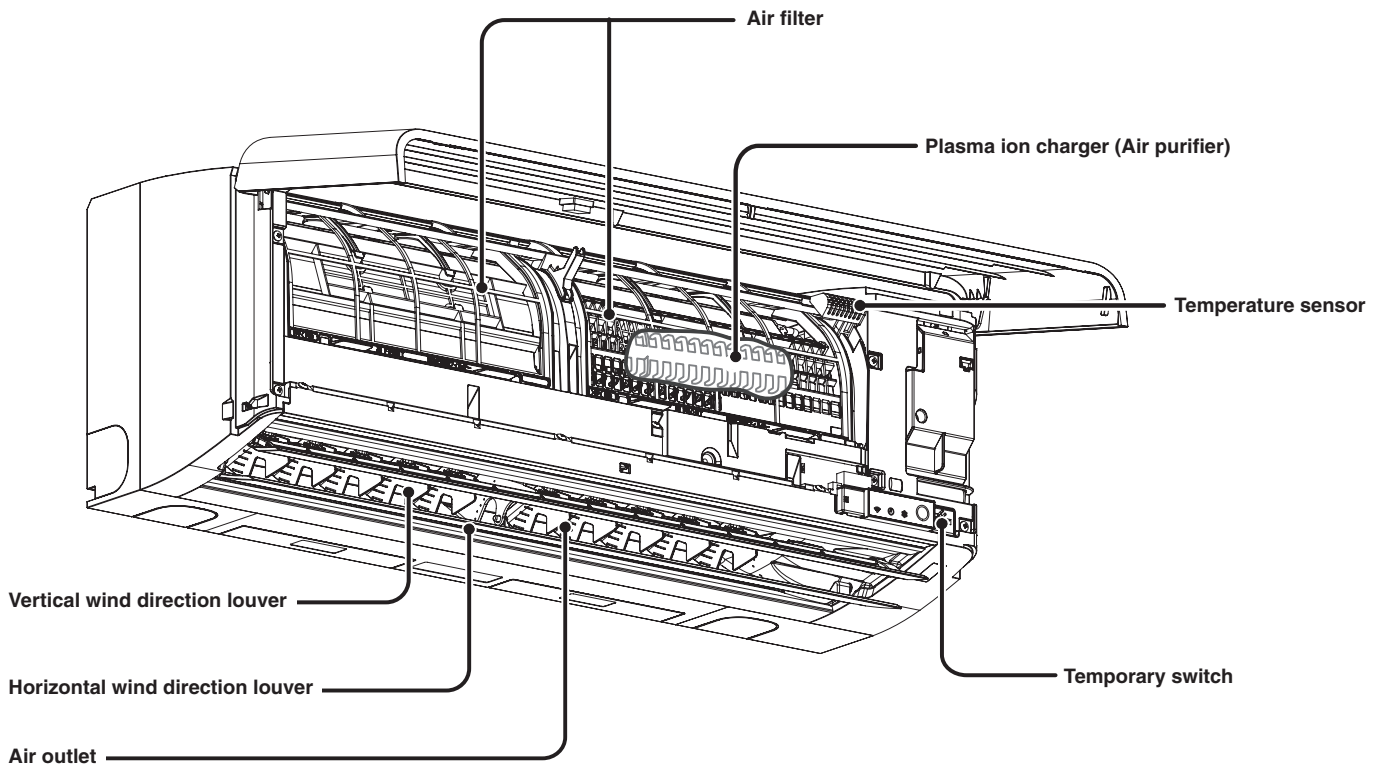

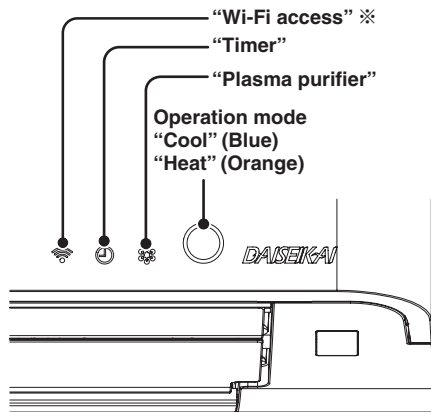
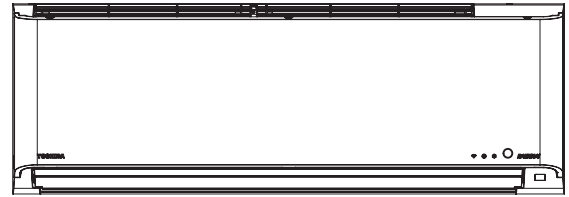
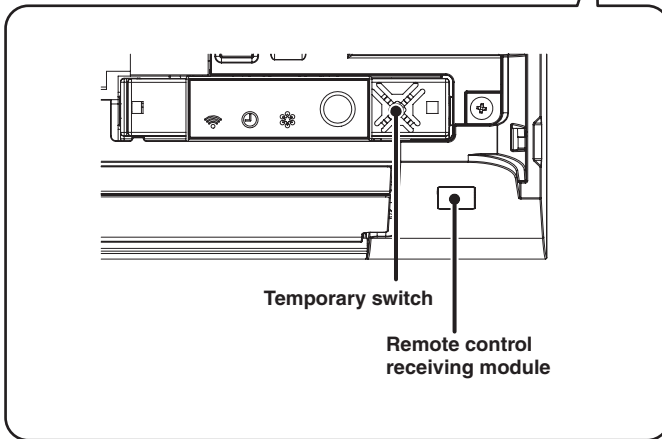
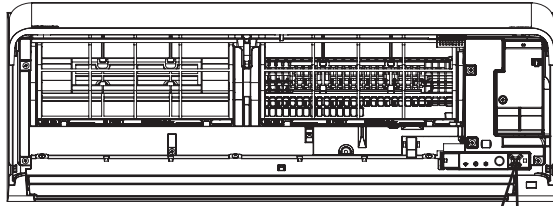

※ Require Wireless LAN connecting adapter which available as accessory.

## Outdoor unit

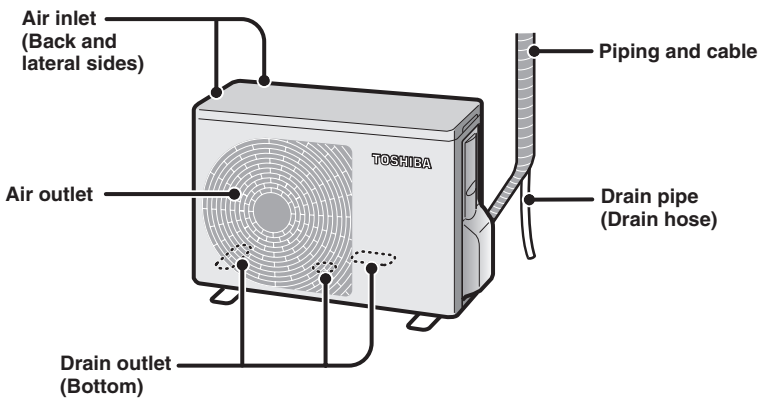

## Accessories

Remote control

Remote control holder



Dry batteries (2 pieces)  
AAA alkaline dry batteries

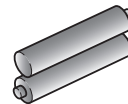

Attachment screws for remote control holder (2 pieces)

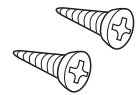

### How to attach the remote control holder

Attach the remote control holder to a wall or a column with the supplied attachment screws for the remote control holder.

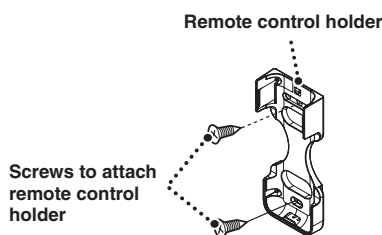

### How to attach / detach from the remote control holder

Insert the "stick out" of the remote control holder into the hole of the lower remote control and set it while pressing toward the direction of arrow.  
Detach it by reversing the procedure.

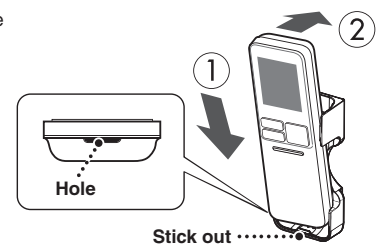



# Parts (continued)

## Remote control

Transmitting part

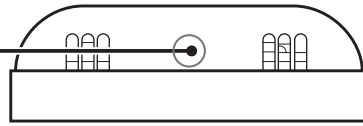

Memory and recall user setting operation

PRESET

Start and Stop operation



TEMP.

Adjust temperature

### Kind of receiving tone

When the indoor unit receives a signal from the remote control, the receiving tone sounds.

- Pi ..... Operation, change
- Pi ..... Stop
- PiPi ..... Notice

When the notice PiPi sounds, it means the operating setting returns to the datum point.

(Example) When temperature setting.



### Datum points

Temperature	24°C	Swing	Cancel
Air volume	Automatic	Horizontal wind direction	Straight
Air flow	Cancel	Vertical wind direction	Lower limit

### How to open the remote control cover

Pull it down while slightly depressing the upper part of the cover.

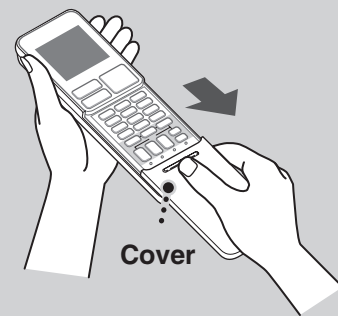



## Remote control on full display

All indicators are shown for explanation.

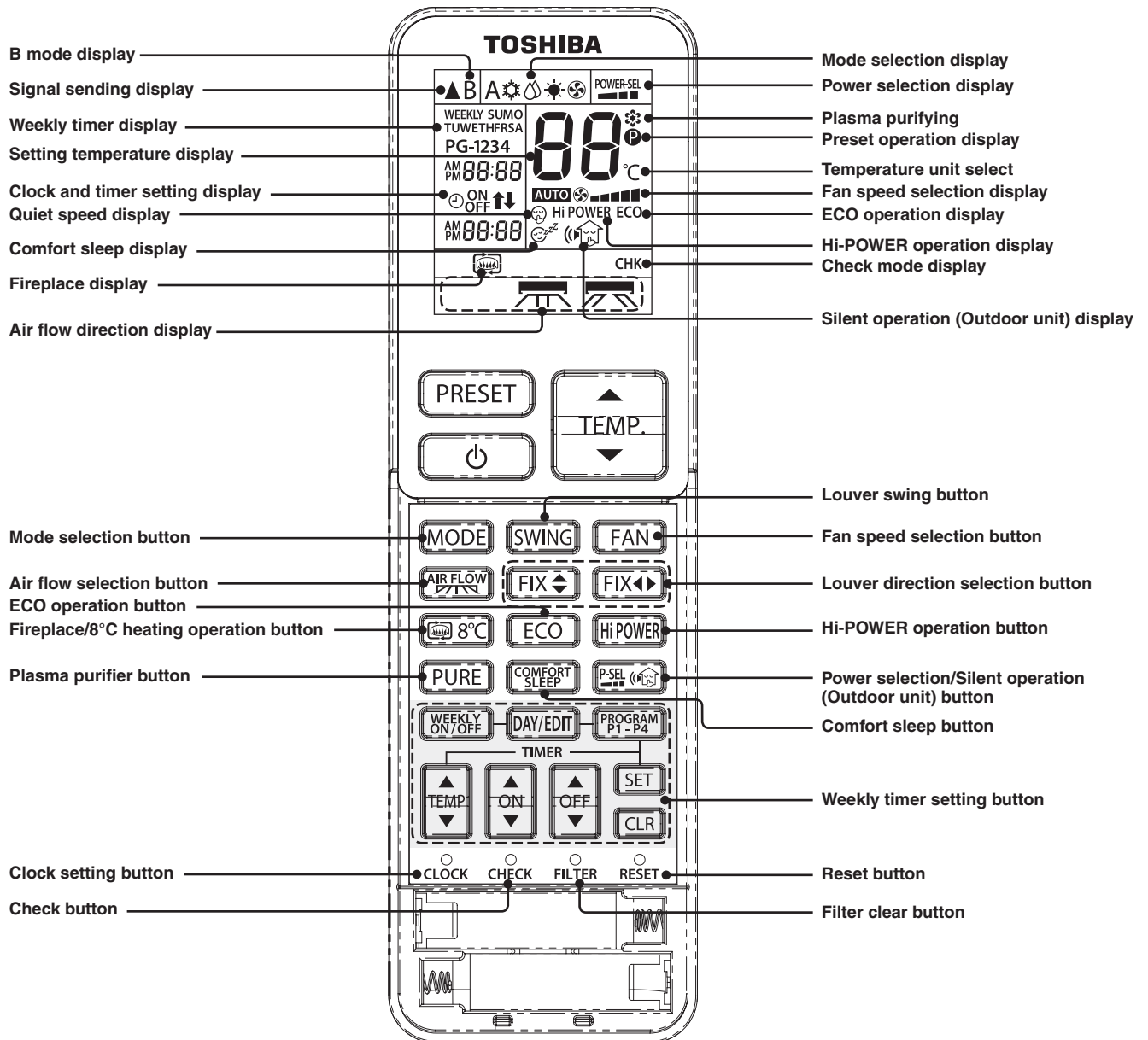

### Notes

- Do not drop and avoid contact with water.
- Do not place where temperature rises or falls (For example exposed to direct sunlight, near a stove, on the TV, hot floor or near a window).
- When other electrical appliances are operated by a remote control, etc., isolate the appliances or consult the distributor.
- If a fluorescent lamp is used near the indoor unit, the remote signal may not reach the infrared signal receiver and, thus, affect the air conditioner ON/OFF operation.
- Do not insert a needle or bar into the opening.

# Preparation before operating the air conditioner

## Remote control

### Insert the battery

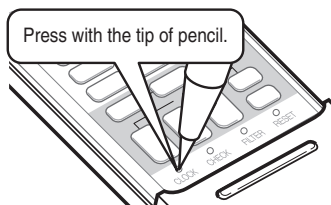

### Setting the clock

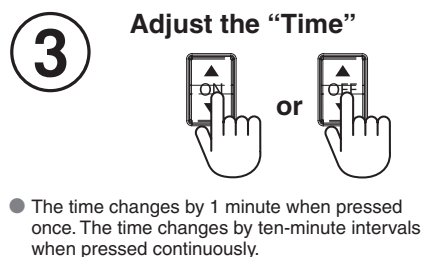
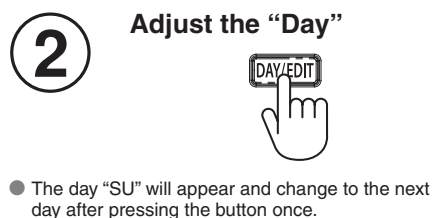
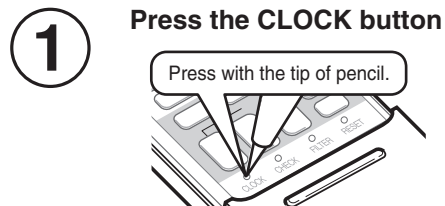
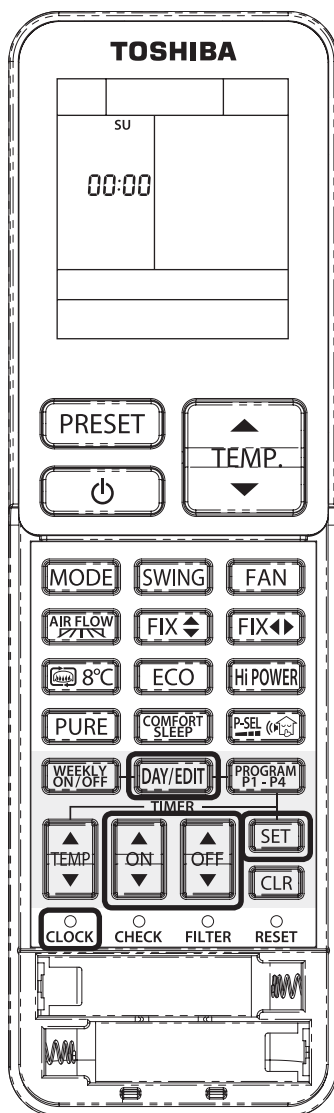

#### Notes

- The life of dry batteries is approx. 1 year in normal use.
- Replace batteries if no sound is received from the indoor unit or there is a failure to select the desired function.
- Replace both batteries at the same time with AAA alkaline batteries.
- If not planning to use for one or more months, remove the batteries to avoid failure.

## Indoor unit

### Turn on the main power supply

- A waiting period of 3 minutes is required after the power is turned on. During this period, the operation lamp will illuminate. However, the compressor will not start.

## Check transmitting and receiving

Point the remote control at the remote control receiving module on the indoor unit.

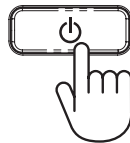

- The correct signal is confirmed by the receiving tone and the operation lamp will illuminate.
- When  button is pressed, the receiving tone will sound and the operation will stop.

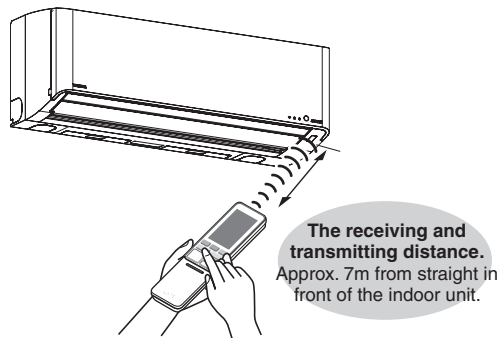

- Check that the signal is transmitted and received at the installed position if the remote control is fixed to the remote control holder.

### Notes

- Use the remote control where the indoor unit can receive the signal. It does not work if the signal is obstructed by curtains or sliding doors.
- The distance for transmitting and receiving is shorter if a bright light, such as sunlight, affects of the main unit.
- The distance for transmission and receiving is shorter if the remote control is operated at an oblique angle to the main unit.



# Hi-POWER operation



To automatically control room temperature and airflow for faster cooling or heating operation (except in DRY and FAN ONLY mode)

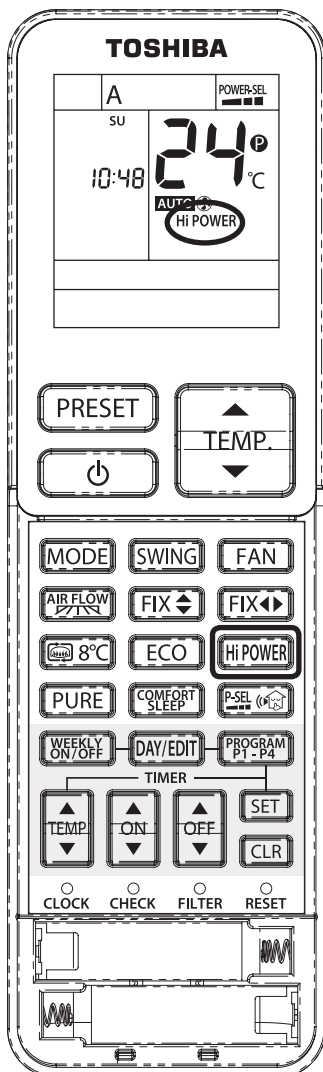

## Hi-POWER operation



- Hi-POWER appears on the remote control display.

# Automatic operation



The air conditioner selects the cooling or heating operation.

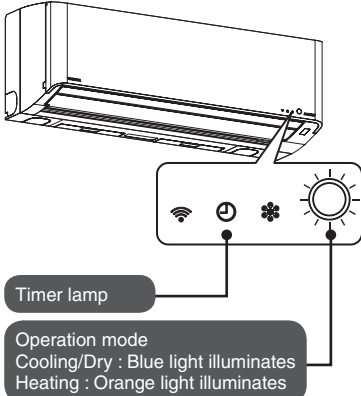

When **PiPi** sounds,

it notices that the operation setting returns to the datum point. [← Page 9](#)

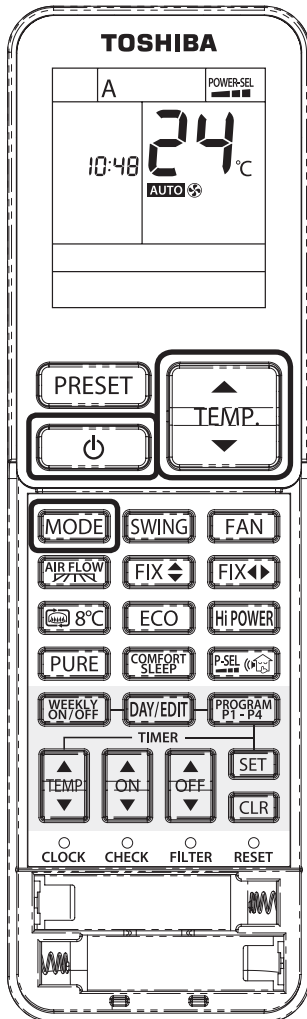

## When starting automatic operation, select **A**

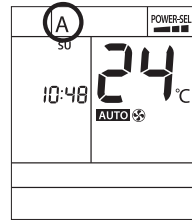

- The air volume can be set as you prefer.

## When it stops.

- After stopping, inside drying operation starts. (Timer lamp is on)
- ※ When operating period is less than 10 minutes, the operation is not performed.

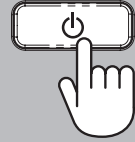

## When changing the temperature **TEMPERATURE**

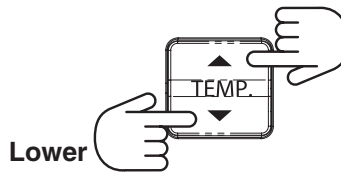

- Changes by 1°C when pressed once. It changes continuously if pressed continuously.
- The temperature range available is 17°C - 30°C.

**PiPi** sounds when reaching 24°C.

# Cooling, Heating, Dry operation and Fan only operation



## Cooling & Heating

Temperature and air volume for the cooling and heating operation can be set as you prefer.

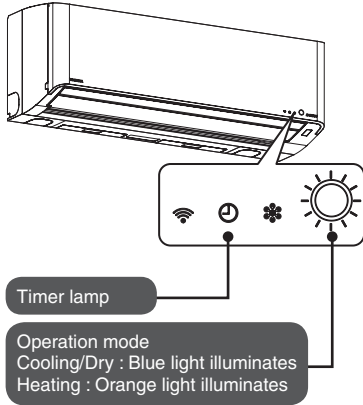

When **PiPi** sounds, it notices the operation setting returns to the datum point.

← Page 9

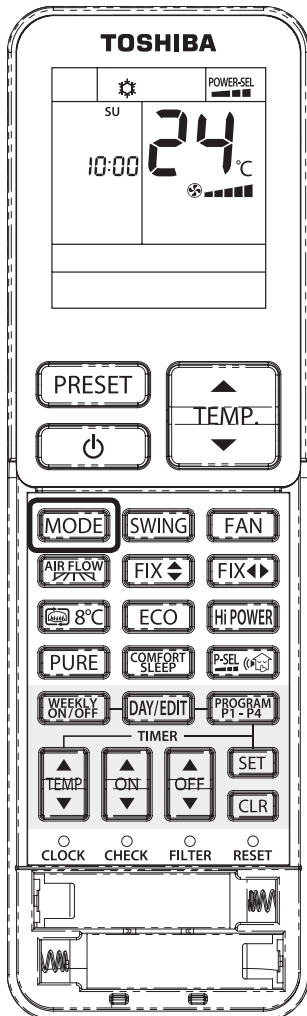

<b>Cooling operation</b>		
<b>Dry operation</b>		
<b>Heating operation</b>		
<b>Fan only operation</b>		

## Defrosting operation while heating

**This is not unusual**

Frost may cover the heat exchanger of the outdoor unit during the heating operation. To prevent performance impairment, defrosting operates automatically. At this time, warm air from the indoor unit may stop, or water or steam may appear from the outdoor unit. However, these features are not unusual. Defrosting function may start immediately after the operation stops.

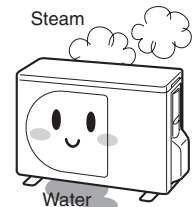



### Dry operation

For dehumidification, a moderate cooling performance is controlled automatically.

#### When changing the temperature

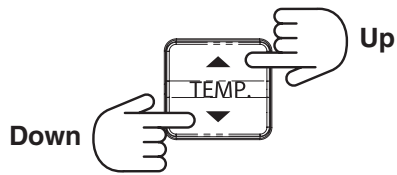

When at 24°C **PIPI**

- The temperature changes by 1°C when pressed. It changes continuously when pressed continuously.
- The available setting range is 17°C – 30°C.

#### When stopping

- Inside drying starts after the operation stops. (TIMER lamp turns on)
- ※ Inside drying lamp will not operate if the operating time is 10 minutes or less.

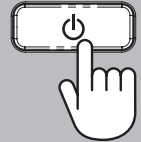

#### Notes

- Refrigerant flow may make noise. However, this is not defect.
- When the outside temperature is low, the temperature in the room may become lower than the temperature selected.
- On dry mode the air volume is set to Auto only.



# Plasma purifier

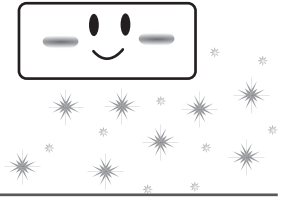

Capture efficiency of floating impurities in the air is accelerated by plasma ion charger. They are caught by the air conditioner and eliminated with the drain water. Thus, the air discharged by the air conditioner is kept clean.

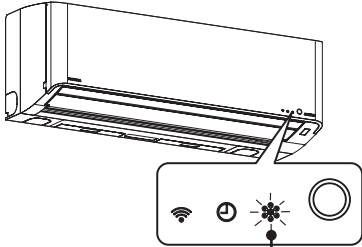

Plasma purifier lamp illuminates

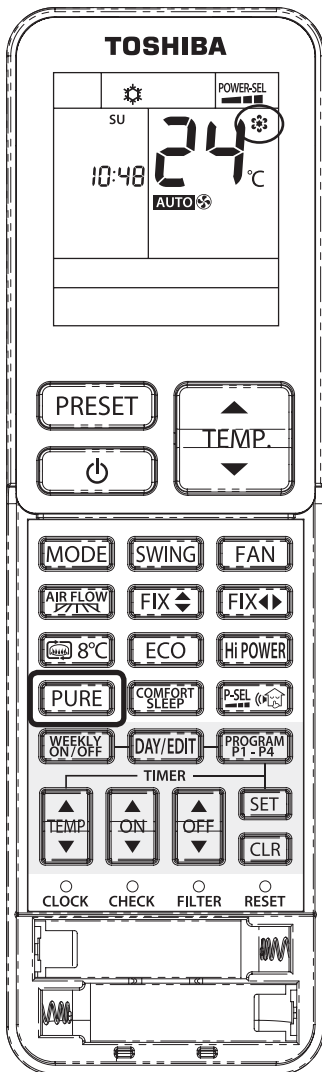

To clean the air,  
**Plasma purifier**

**When stopping operation.**

- After stopping, automatic cleaning starts (TIMER lamp turns on).
- ※ When operating time is 10 minutes or less, cleaning function does not operate.

## When using together with the air conditioning

Air volume and direction setting of air conditioner have priority.

Operation	Operate Plasma purifier while air conditioning.	Press the <b>PURE</b> button.
	Operate air conditioning during Plasma purifier.	Press <b>MODE</b> to select.
Stop	Stop both Plasma purifier and air conditioning.	Press the <b>⏻</b> button.
	Stop only Plasma purifier.	Press the <b>PURE</b> button.

**Notes**

- Plasma purifier operation does not remove harmful substances from cigarette smoke (carbon monoxide etc.). Open a window occasionally for ventilation.

# Air volume, Air direction and Swing louvers

When **PiPi** sounds, it indicates the operation setting returns to the original setting. [← Page 9](#)

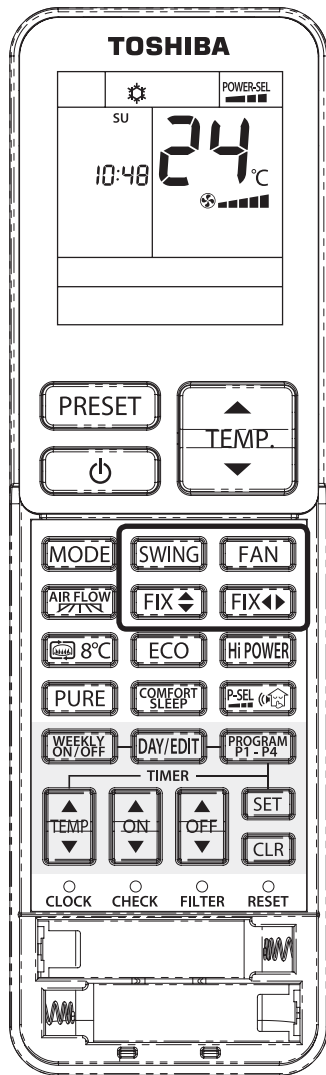

## Movement of vertical air direction louvers

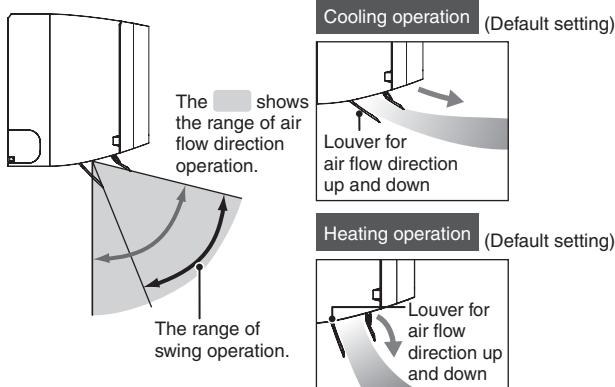

## Changing the air volume, press FAN

● **Every time...**  
When pressed during Auto, Cooling, Fan only and PURE.

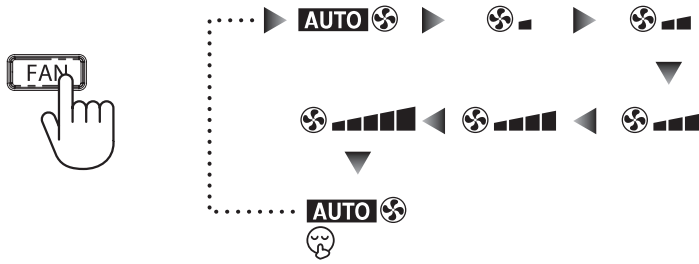

● When the air volume is set to "Quiet" (represented by a fan icon with a small bar), the air volume becomes "Automatic".

## Changing the air direction, press FIX

When changing the air to the vertical direction, release the left side at the desired position. (**PiPi** at the lower limit).

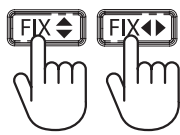

When changing the air to the horizontal position, release the right side at the desired position. (**PiPi** sounds at the center position).

**Setting for air flow** [Page 19](#)

- Comfort air direction can be selected as a Wide air flow and Spot air flow.
- When pressed the vertical and horizontal louver modes change one step.
- Do not move the air direction louvers by hand adjust only with the remote control.

## Swing louvers operation, press Swing

● **Every time...**

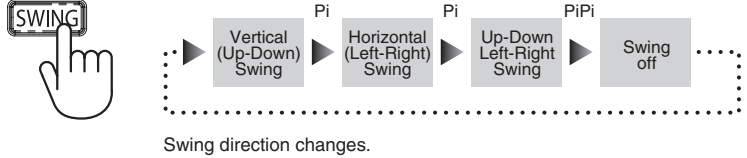

● When changing the middle vertical direction louver, press the **FIX** button and to change the middle horizontal direction louver, press the **FIX** button again. To see current air direction, release the swing functions.

# Comfort air flow



**Wide air flow :** Air flows around the room.  
**Spot air flow :** Air flow is concentrated at one point.

Wide air flow

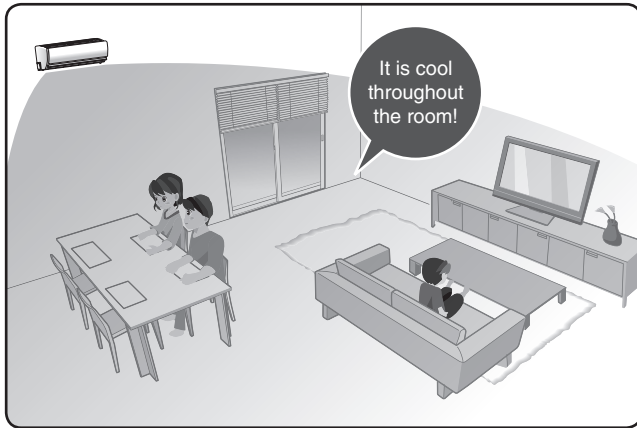

Spot air flow

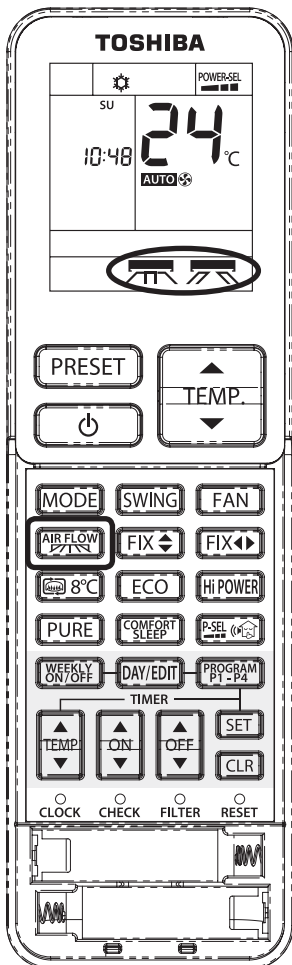
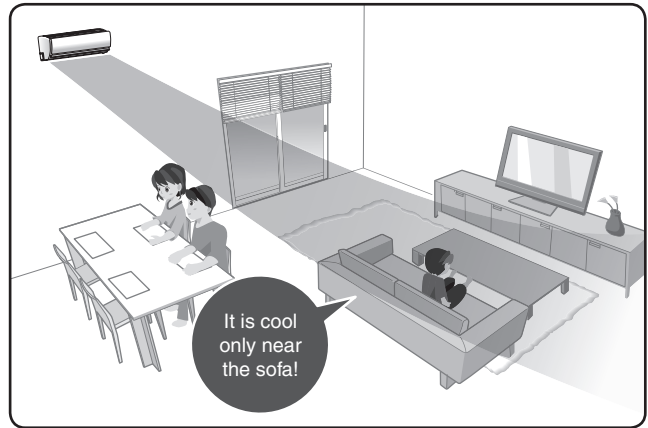

Comfortable air flow can be selected from

**AIR FLOW**

While operating (Auto, Cool, Heat, Dry and these modes with PURE), Select

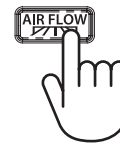

- **Every time...**  
When pressed, the air flow direction changes.

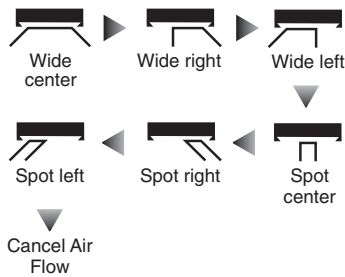

- Pressing Indoor unit causes "Pi" sound (receiving tone) and "PiPi" sound when AIR FLOW is canceled.

### When adjusting the air direction slightly

- Adjust "Air flow direction" with the **FIX** or **FIX** button. To know the air direction easily, release the swing function. [← Page 18](#)
- When the **FIX** or **FIX** or **SWING** button is pressed and when Wide air flow or spot air flow is selected, the Air flow direction is released.

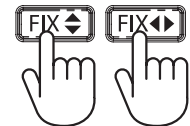

### Notes

- Horizontal and vertical air flow direction louvers change depending on the selection of wide air flow or spot air flow.
- If the operation is stopped during the comfort air flow operation, the same conditions apply to the next function selected.
- **AIR FLOW** does not operate if only the Plasma purifier function is working.
- Horizontal direction louvers can be adjusted within a range of approx. 30 degrees when wide air flow or spot air flow is selected.

# Timer operation

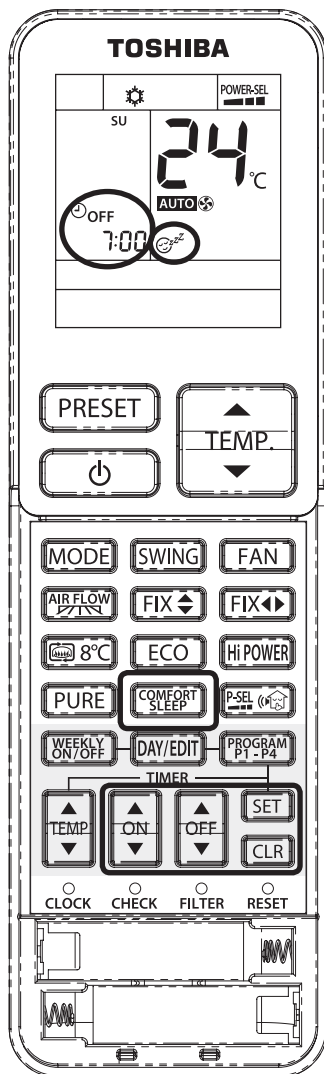
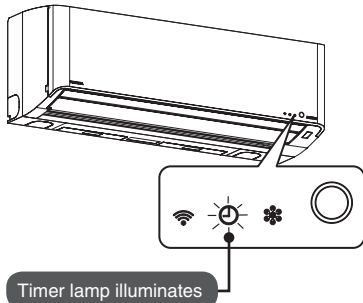

## Comfort sleep

The operation stops automatically at the Pre-set time. When 1, 3, 5 and 9 hours are selected, the comfort sleep operation begins. The set temperature will be automatically adjusted appropriately. However, the temperature is raised or decreased to no more than 2 degrees Celsius.

### Timer off during comfort sleep

- Every time when pressed (within 3 seconds)...  
※ Display example is when 10:00 is selected.

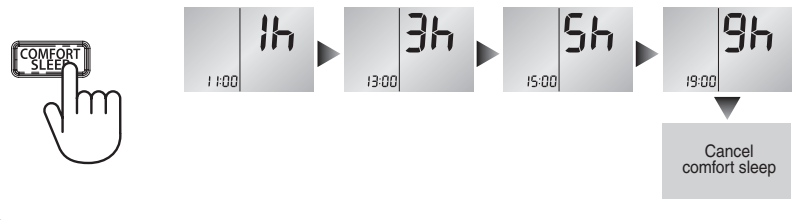

- The time for stopping the operation is displayed on the remote control.
- After the operation stops, drying of the inside is not performed.
- Comfort sleep operation cannot be set up when Plasma purifier functions are operating independently.

### To cancel

※ The timer setting is released but operation continues.

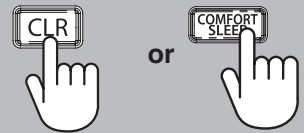





## Timer on, Timer off

Start and stop of operation is selected with the time. Operate after setting the current time on the remote control  Page 11

1

For timer on



For timer off

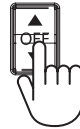



- Changes by 10 minutes when pressed once and by 1 hour when pressed continuously.
- The selected time is displayed
- Go to ② if the same time as a previous setting can be used.

2

Select



- During time off, drying inside is not performed.
- Timer off can be selected with the previous operation setting even while stopped. The operation starts when selected.
- To change the selected time, press  or  to change the setting.

### To cancel

※ The timer setting is released, but the operation will continue.



### Example of setting (Selection of timer On/Off)

To start at 6:00 AM and stop at 10:00 AM.

1

Select operation start for 6:00 AM.



Selected time and current operating mode blink alternately in the pictographic character display portion.

2

Set the stop time to 10:00 AM.



Selected time and current operating mode blink alternately in the pictographic character display portion.

3



# Weekly timer operation

- 4 programs for each day in the week can be set in WEEKLY TIMER.  
 The following items can be set in WEEKLY TIMER operation.
- a. Operation time (ON timer for Start and OFF timer for Stop operation)
  - b. Operation mode (COOL, DRY, HEAT, FAN ONLY)
  - c. Temperature setting.
  - d. Fan speed setting.
  - e. Special operation (8°C, ECO, Hi-POWER, Silent)

## Examples of WEEKLY TIMER uses

### 1 Living room

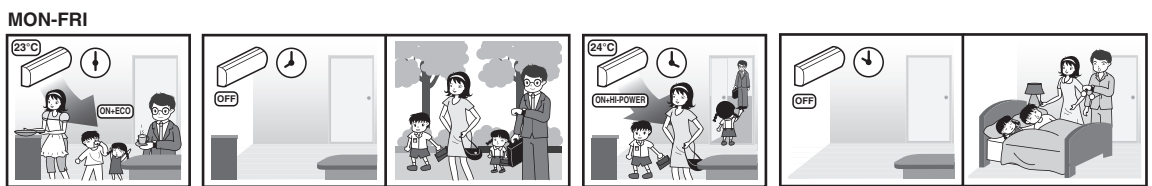

#### SUN and SAT

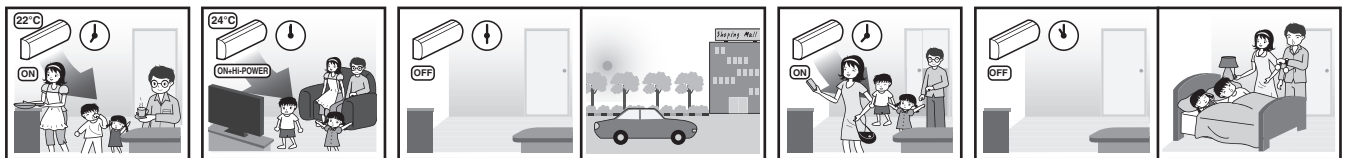

### 2 Living room with heavy cool (Non-stop air conditioning)

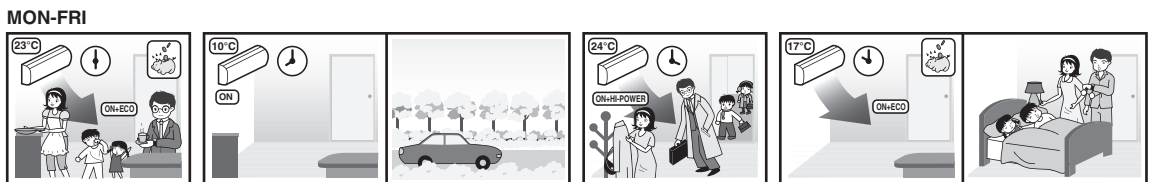

#### SUN and SAT



### 3 Bedroom

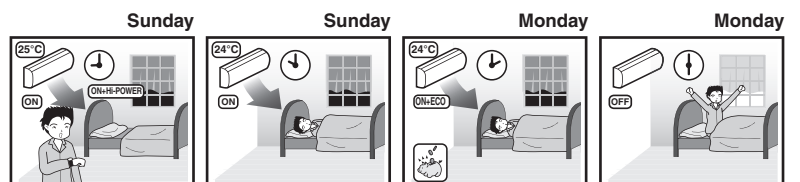

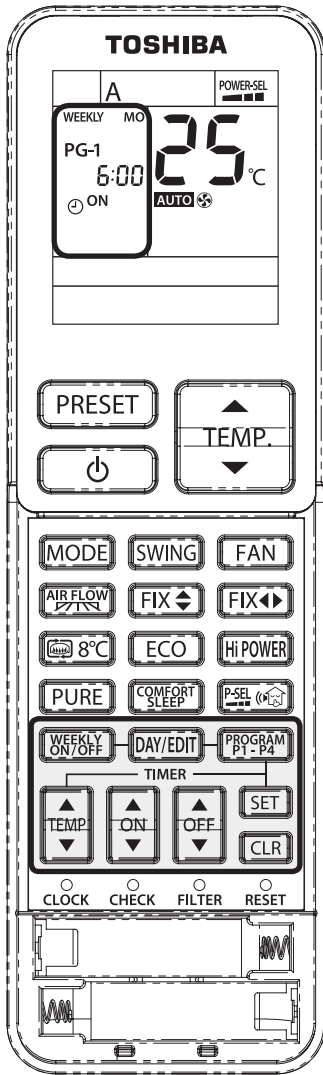

## How to set WEEKLY TIMER

- 1** Press **DAY/EDIT** to enter WEEKLY TIMER setting.

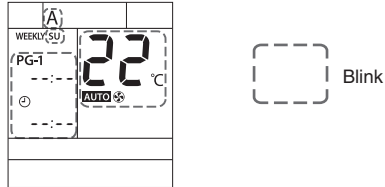

- 2** Press **DAY/EDIT** to select desired day in sequence.  
The sequence of day symbol appears on the LCD

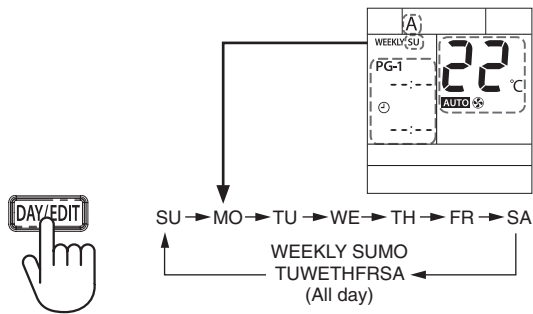

- 3** Press **PROGRAM P1-P4** to select the program number.

- The program 1 is ready for setting while **DAY/EDIT** is pressed PG-1 appears on the LCD.
- Press **PROGRAM P1-P4** to change the program number in the sequence program 1 to program 4.

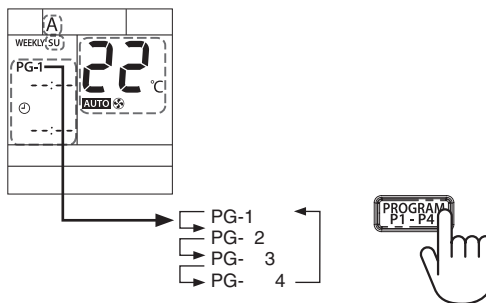

- 4** Press **ON** or **OFF** to select the desired time.

- The time can be set between 0:00 and 23:50 in 10 minute intervals.
- Press and hold the button to change setting time for 1 hr.
- Only one of ON or OFF timer can be set on each program.

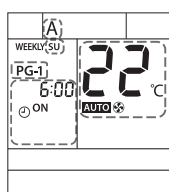

ON timer display

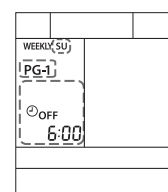

OFF timer display\*

\*OFF timer is used to stop the air conditioner only. The display does not show Operation mode, Temperature, Fan speed and others.

**5** Press **MODE** to select desired operation.



**6** Press **TEMP.** or **TEMP.** to select desired temperature.

- The temperature can be set between 17°C and 30°C.

**7** Press **FAN** to select the desired fan speed.

**8** Add operations, if required.

- Press **8°C** to use 8°C operation. (Notes: Fireplace cannot select and memorize in weekly function)
- Press **ECO** to use ECO operation
- Press **HI-POWER** to use Hi-POWER operation.
- Press **POWER-SEL** to use Silent operation.

**9** Adding or editing the program.

The program can be set to perform on all the required days until **SET** is pressed to confirm the setting **10**.

If adding or editing a program is required, please repeat steps **2** - **8** before setting confirmation.

**10** After adding or editing, press **SET** to confirm the setting\*.

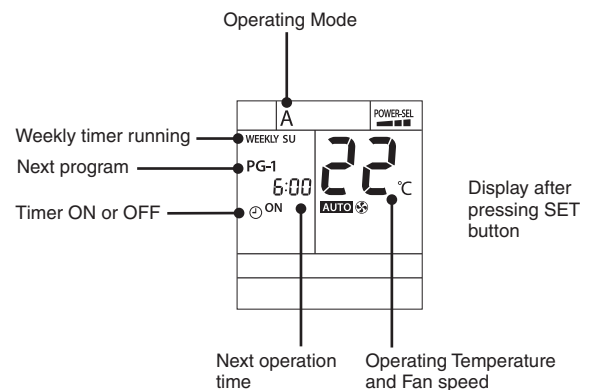

\*Point remote control at air conditioner receiving module then, press SET button until you hear the "PiPi" sound. This means the setting operation has been completed. As the air conditioner is receiving the signal, you will hear separate "Pi" sounds corresponding to the number of days in the selected setting. An incomplete setting is indicated if the TIMER lamp is blinking. Press **WEEKLY ON/OFF** twice.

#### Notes

1. Place the remote control where the indoor unit can receive the signal. This will increase the accuracy of the timing between the remote control and the air conditioning unit.
2. The ON/OFF timer can be set during the WEEKLY TIMER operation. In this situation, the air conditioner will first follow the normal timer until it is complete; then, it will return to the WEEKLY TIMER function.
3. During WEEKLY TIMER operation, all of operation such as MODE, TEMP, FAN, Hi-POWER, ECO and etc., can be adjusted but when the clock reaches the program setting, the operation will return to the set items in the program.
4. When the remote control is sending a signal to the air conditioner, avoid interference from objects that can block the signal.

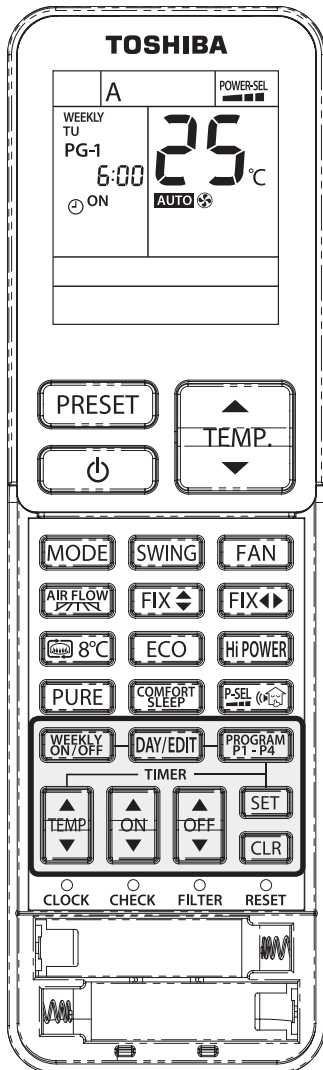

## Edit Weekly timer program

To edit the program after confirming the weekly timer setting on [Page 24](#), follow steps ① - ③ below.

- ① Press **DAY/EDIT**.
  - The day of the week and the program number of the current day will be displayed.

---

- ② Press **DAY/EDIT** to select the day of the week and press **PROGRAM P1 - P4** to select program number to be confirmed.
  - Resetting the operation.

---

- ③ Press **SET** to exit confirming mode.

## Deactivating WEEKLY TIMER operation

Press **WEEKLY ON/OFF** while “WEEKLY” is displayed on the LCD.

- The “WEEKLY” indicator will disappear from the LCD. However, the program will remain in the remote control.
- The TIMER lamp goes off.
- To reactivate the WEEKLY TIMER operation again, press **WEEKLY ON/OFF** again, LCD shows the next program. The program, after reactivation, is related to the clock time.

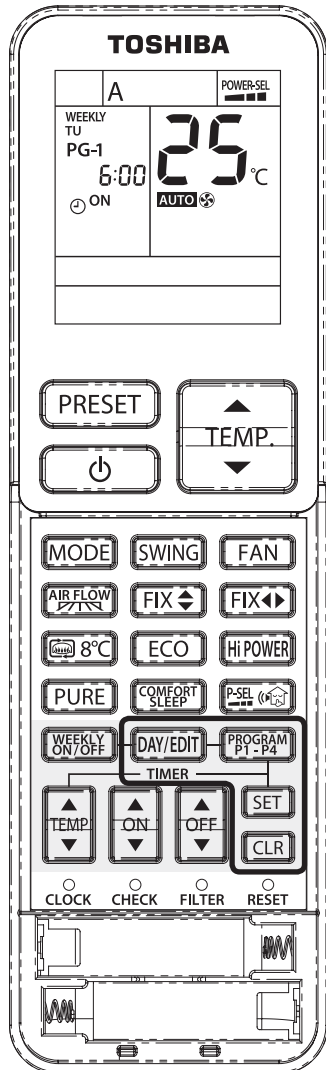

## To delete programs

### The individual program

- 1 Press **DAY/EDIT**.
  - The day of the week and the program number is displayed.
  - Select the day to delete the program.

---

- 2 Press **PROGRAM P1-P4** to select the program number to be deleted.

---

- 3 Press **CLR**.
  - ON or OFF timer will be cleared and the LCD will blink.

---

- 4 Press **SET** to delete the program.
  - Press **SET** while the LCD is blinking. The program has now been deleted.

### All programs

- 1 Press **DAY/EDIT**.
  - The day of the week and the program number will be displayed.

---

- 2 Press **CLR** and hold for 3 seconds.
  - All programs will be deleted and LCD displays current operation.

#### Notes

Make sure the remote control receiving module on the air conditioner receives the signal from the remote control.



# WEEKLY TIMER usage example

## Living room (Example #1)

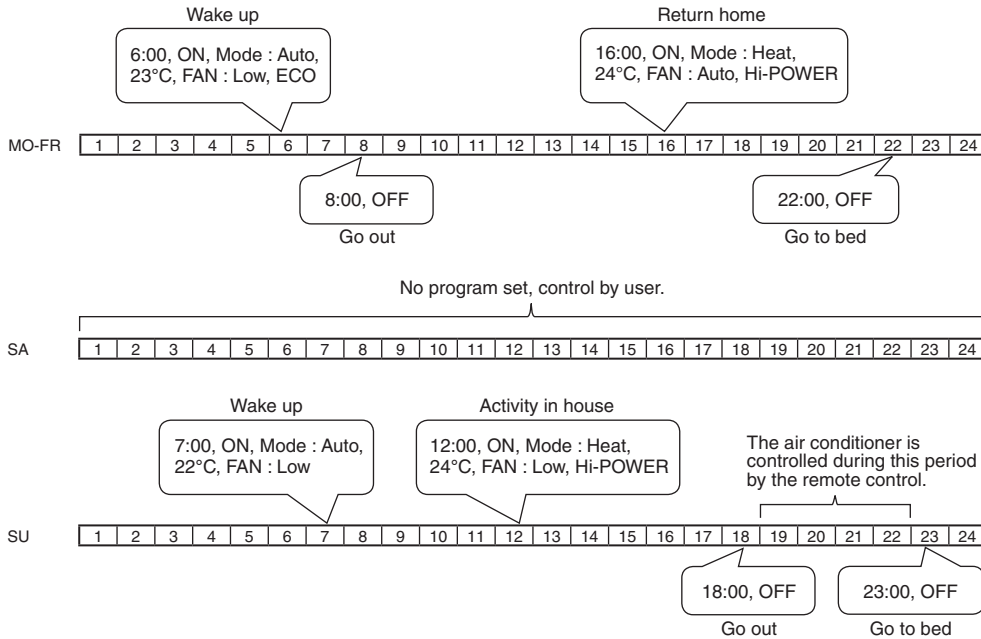
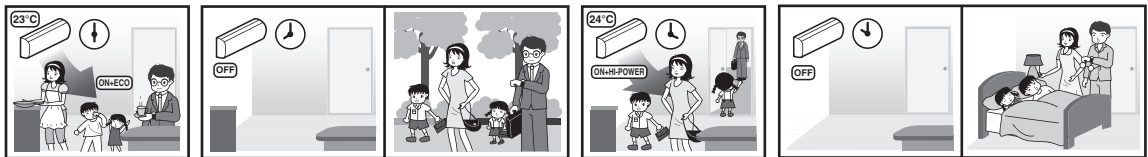

Table for living room operation.

	Setting	SU	MO	TU	WE	TH	FR	SA
PG-1	Timer	ON	ON	ON	ON	ON	ON	-
	Clock	7:00	6:00	6:00	6:00	6:00	6:00	-
	Mode	Auto	Auto	Auto	Auto	Auto	Auto	-
	Temperature	22°C	23°C	23°C	23°C	23°C	23°C	-
	Fan	Low	Low	Low	Low	Low	Low	-
Add on operation	-	ECO	ECO	ECO	ECO	ECO	ECO	-
PG-2	Timer	ON	OFF	OFF	OFF	OFF	OFF	-
	Clock	12:00	8:00	8:00	8:00	8:00	8:00	-
	Mode	Heat	-	-	-	-	-	-
	Temperature	24°C	-	-	-	-	-	-
	Fan	Hi-POWER	-	-	-	-	-	-
Add on operation	-	-	-	-	-	-	-	
PG-3	Timer	OFF	ON	ON	ON	ON	ON	-
	Clock	18:00	16:00	16:00	16:00	16:00	16:00	-
	Mode	-	Heat	Heat	Heat	Heat	Heat	-
	Temperature	-	24°C	24°C	24°C	24°C	24°C	-
	Fan	-	Auto	Auto	Auto	Auto	Auto	-
Add on operation	-	Hi-POWER	Hi-POWER	Hi-POWER	Hi-POWER	Hi-POWER	-	
PG-4	Timer	OFF	OFF	OFF	OFF	OFF	OFF	-
	Clock	23:00	22:00	22:00	22:00	22:00	22:00	-
	Mode	-	-	-	-	-	-	-
	Temperature	-	-	-	-	-	-	-
	Fan	-	-	-	-	-	-	-
Add on operation	-	-	-	-	-	-	-	

## Living room

### MON-FRI



### SUN and SAT

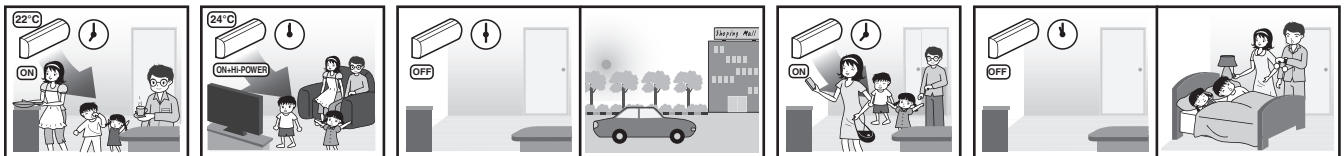

# WEEKLY TIMER usage example (continued)

## Living room with heavy cool (Example #2) (Non-stop air conditioning)

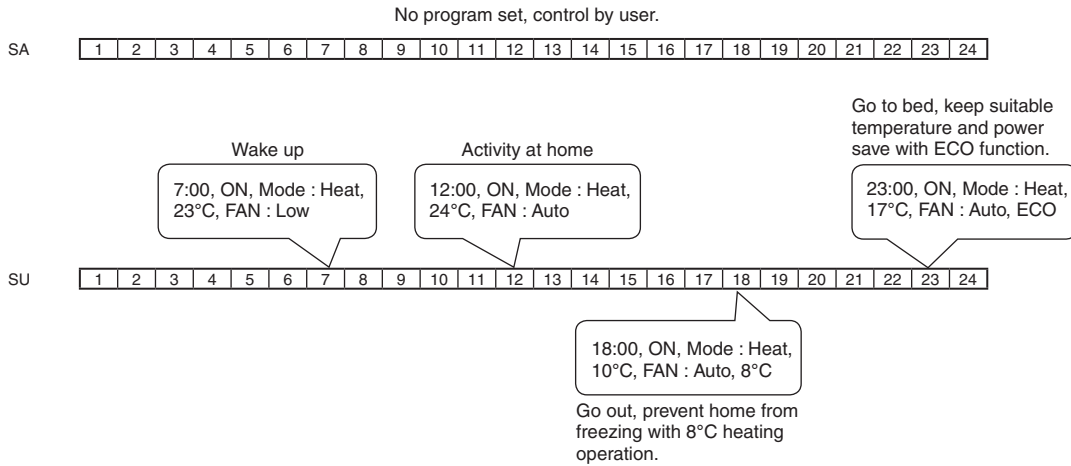
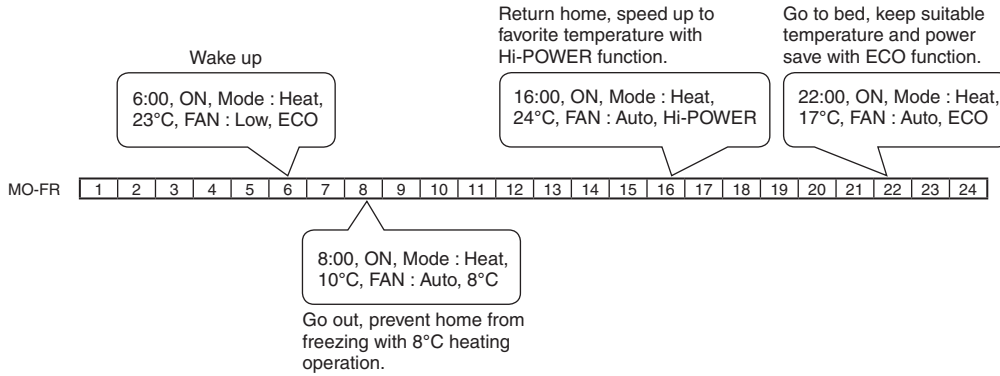

Table for living room operation.

	Setting	SU	MO	TU	WE	TH	FR	SA
PG-1	Timer	ON	ON	ON	ON	ON	ON	-
	Clock	7:00	6:00	6:00	6:00	6:00	6:00	-
	Mode	Heat	Heat	Heat	Heat	Heat	Heat	-
	Temperature	23°C	23°C	23°C	23°C	23°C	23°C	-
	Fan	Low	Low	Low	Low	Low	Low	-
	Add on operation	-	ECO	ECO	ECO	ECO	ECO	-
PG-2	Timer	ON	ON	ON	ON	ON	ON	-
	Clock	12:00	8:00	8:00	8:00	8:00	8:00	-
	Mode	Heat	Heat	Heat	Heat	Heat	Heat	-
	Temperature	24°C	10°C	10°C	10°C	10°C	10°C	-
	Fan	Auto	Auto	Auto	Auto	Auto	Auto	-
	Add on operation	-	8°C	8°C	8°C	8°C	8°C	-
PG-3	Timer	ON	ON	ON	ON	ON	ON	-
	Clock	18:00	16:00	16:00	16:00	16:00	16:00	-
	Mode	Heat	Heat	Heat	Heat	Heat	Heat	-
	Temperature	10°C	24°C	24°C	24°C	24°C	24°C	-
	Fan	Auto	Auto	Auto	Auto	Auto	Auto	-
	Add on operation	8°C	Hi-POWER	Hi-POWER	Hi-POWER	Hi-POWER	Hi-POWER	-
PG-4	Timer	ON	ON	ON	ON	ON	ON	-
	Clock	23:00	22:00	22:00	22:00	22:00	22:00	-
	Mode	Heat	Heat	Heat	Heat	Heat	Heat	-
	Temperature	17°C	17°C	17°C	17°C	17°C	17°C	-
	Fan	Auto	Auto	Auto	Auto	Auto	Auto	-
	Add on operation	ECO	ECO	ECO	ECO	ECO	ECO	-

\*Remark: If no program is set for SATURDAY, the program will refer to the latest operation (FRIDAY, PG-4 = Heat mode, 17°C, Fan = Auto, ECO). On that day, the user can select the air conditioner mode via remote control.

# WEEKLY TIMER usage example (continued)

## Living room with heavy cool (Non-stop air conditioning)

MON-FRI

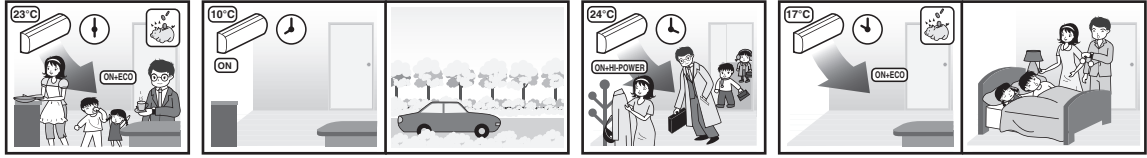

SUN and SAT



## Bedroom (Example#3)

More power save by ECO function with desired temperature.

2:00, ON,  
Mode : Auto, 24°C,  
FAN : Low, ECO

Wake up  
6:00, OFF

Speed up adjustment to desired temperature with Hi-POWER function.

21:00, ON, Mode : Heat,  
25°C, FAN : Auto,  
Hi-POWER

Release Hi-POWER to normal operation for power save.

22:00, ON,  
Mode : Auto,  
24°C, FAN : Auto

More power save by ECO function with desired temperature.

2:00, ON,  
Mode : Auto, 24°C,  
FAN : Low, ECO

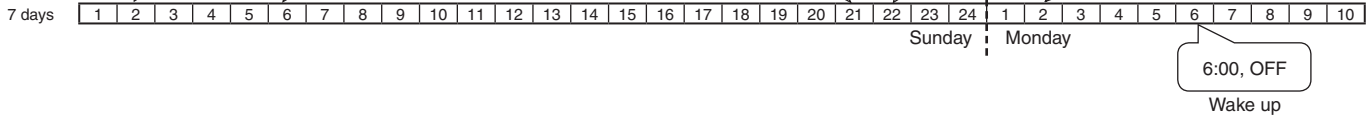
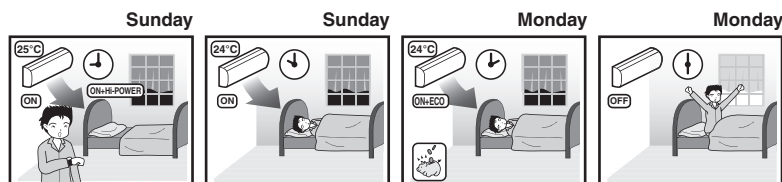

Table for bedroom operation.

Setting	SU	MO	TU	WE	TH	FR	SA
PG-1	Timer	ON	ON	ON	ON	ON	ON
	Clock	2:00	2:00	2:00	2:00	2:00	2:00
	Mode	Auto	Auto	Auto	Auto	Auto	Auto
	Temperature	24°C	24°C	24°C	24°C	24°C	24°C
	Fan	Low	Low	Low	Low	Low	Low
Add on operation	ECO	ECO	ECO	ECO	ECO	ECO	
PG-2	Timer	OFF	OFF	OFF	OFF	OFF	OFF
	Clock	6:00	6:00	6:00	6:00	6:00	6:00
	Mode	-	-	-	-	-	-
	Temperature	-	-	-	-	-	-
	Fan	-	-	-	-	-	-
Add on operation	-	-	-	-	-	-	
PG-3	Timer	ON	ON	ON	ON	ON	ON
	Clock	21:00	21:00	21:00	21:00	21:00	21:00
	Mode	Heat	Heat	Heat	Heat	Heat	Heat
	Temperature	25°C	25°C	25°C	25°C	25°C	25°C
	Fan	Auto	Auto	Auto	Auto	Auto	Auto
Add on operation	Hi-POWER	Hi-POWER	Hi-POWER	Hi-POWER	Hi-POWER	Hi-POWER	
PG-4	Timer	ON	ON	ON	ON	ON	ON
	Clock	22:00	22:00	22:00	22:00	22:00	22:00
	Mode	Auto	Auto	Auto	Auto	Auto	Auto
	Temperature	24°C	24°C	24°C	24°C	24°C	24°C
	Fan	Auto	Auto	Auto	Auto	Auto	Auto
Add on operation	-	-	-	-	-	-	

## Bedroom



# Set preferred operation



Set your preferred operation for future use.  
The setting will be stored in the memory and can be used for future requirements.

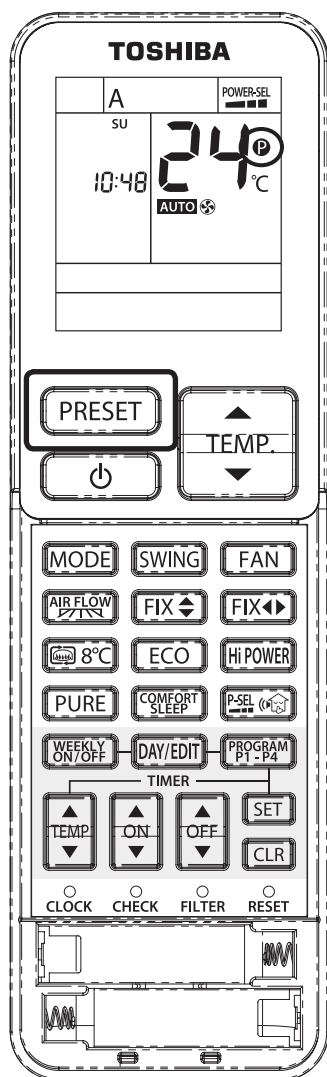

## PRESET OPERATION

- 1 Select your preferred operation.
- 2 Press and hold **PRESET** for 3 seconds to store the setting.  
The **P** mark displays.
- 3 Press **PRESET** to operate the preset operation.

### The following functions cannot be set:

- ※ Fireplace/8°C heating operation
- ※ Weekly timer
- ※ Louver swing

# Energy Saving



While Automatic, Cooling or Heating operation is activated, this function provides automatic control for the setting of room temperature.

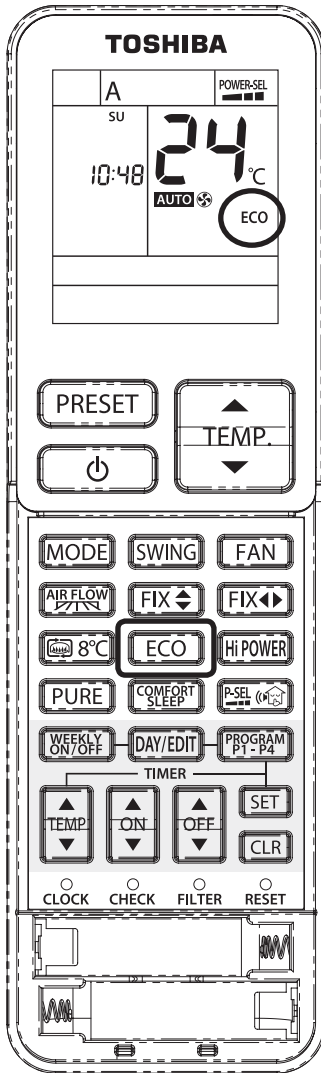

## ECO OPERATION



- ECO appears on the remote control display.
- The set temperature will be automatically adjusted appropriately. However, the temperature is raised by no more than 2 degree Celsius.

# Limit maximum : Electric Power consumption and Silent Operation (Outdoor Unit)

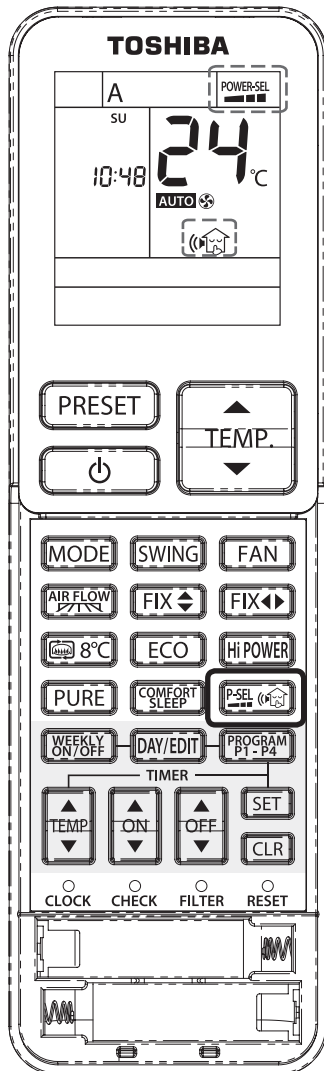

## Power-Selection ( P-SEL )

This function is used when the circuit breaker is shared with other electrical appliances. It limits the maximum current and power consumption to 100%, 75%, or 50% and can be implemented by POWER-SELECTION. The lower percentage, the higher Saving and also longer compressor lifetime.

### Notes

- When the level is selected, POWER-SELECTION level flashes on remote LCD display for 3 seconds.  
In case of 75% and 50% level, number "75" or "50" also flashes for 2 seconds.
- Due to the reason that POWER-SELECTION function limits the maximum current, inadequate cooling or heating capacity may occur.

## Silent Operation ( )

Keep outdoor unit operating silently to ensure either yourself or neighborhood will have a tight sleep in nighttime.

By this feature, the heating capacity will be optimized to deliver such silent experience.

The silent operation can be selected from one of two purposes (Silent 1 and Silent 2).

There are three setting parameters: Standard level > Silent 1 > Silent 2

### Silent 1:

Though operating silently, the Heating (or Cooling) capacity is still prioritized to ensure having sufficient comfort inside the room.

This setting is a perfect balance between the Heating (or Cooling) capacity and the Sound level of outdoor unit.

### Silent 2:

Compromising the Heating (or Cooling) capacity to the Sound level in any circumstance where the outdoor unit's sound level is highly prioritized.

This setting has a purpose to reduce the maximum sound level of outdoor unit by 4 dB(A).

### Notes

- While activating of Silent operation, inadequate heating (or cooling) capacity may occur.

## Power-Selection and Silent Operation (Outdoor Unit)

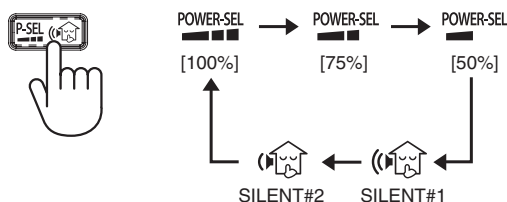

# Fireplace and 8°C Heating Operation

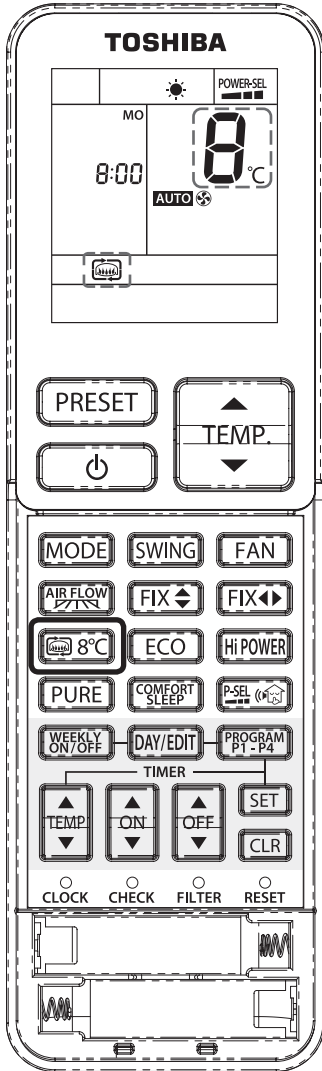

## Fireplace Operation ( )

Keep indoor unit's fan blowing continuously during thermo off, to circulate heat from other sources over the room.

There are three setting parameters: Default setting > Fireplace 1 > Fireplace 2

### Fireplace 1:

The indoor unit's fan will continue to run by the same speed, previously selected by end-user.

### Fireplace 2:

The indoor unit's fan will continue to run at super-low speed, programmed from factory.

## 8°C Heating Operation ( 8°C )

Heat mode operation for keep room temperature (5-13°C) with less of energy usage.

## Fireplace and 8°C Operation

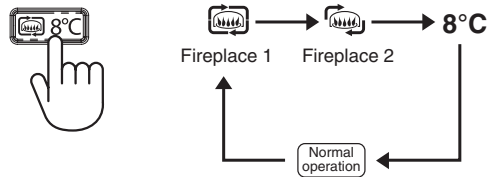



# Operation of display lamp brightness adjustment



This function is used when it is necessary to decrease the display lamp brightness or turn it off.

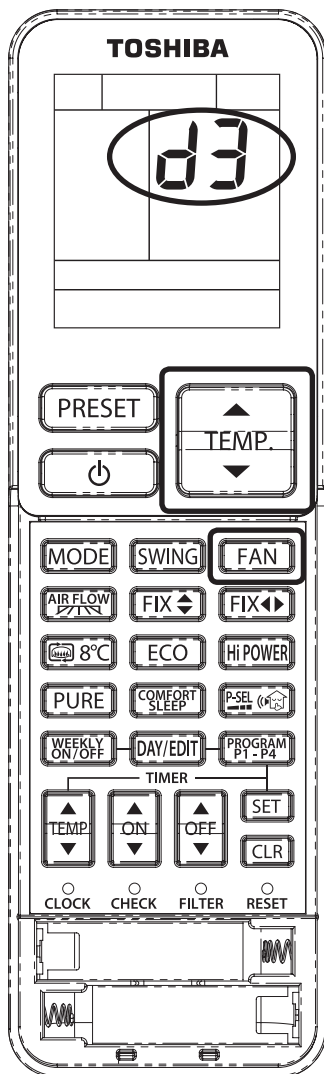
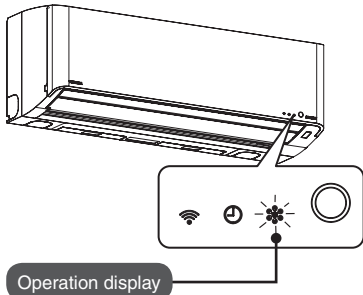

## LAMP BRIGHTNESS ADJUSTMENT

While operating (Auto, Cool, Heat or Dry), press and hold **FAN** 5 seconds.

Press Rise or Decrease to adjust brightness which can be set at 4 levels or to turn it off.

Remote control LCD	Operation display	Brightness
d3	Lamp illuminates an operation with full brightness.	100%
d2	Lamp illuminates an operation with 50% brightness.	50%
d1	Lamp illuminates an operation with 50% brightness and the operation mode lamp is turned off.	50%
d0	All lamps are turned off.	All turned off

● In the examples of **d1** and **d0**, the lamp illuminates for 5 seconds before going off.

# Inside drying operation

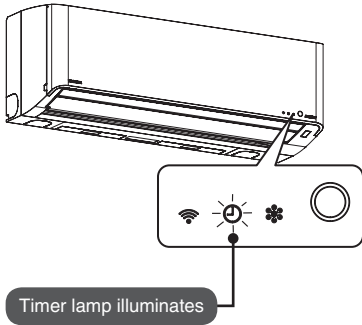

Inside drying operation is started after operations of 10 minutes or longer.

To stop Inside drying during operation, press  2 more times.

※ After stopping the inside drying operation by remote control and starting the air conditioner, the next operation may be delayed.

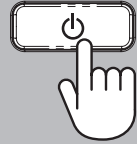

Inside drying operation

Approx 30 minutes

To prevent the growth of mold, air cleaning is performed.

● Vertical direction louvers move.

※ Inside drying operation will not be activated if previous operation is Heating, Fan only or plasma purifier.

## About Inside drying operation

- Inside drying operation does not clean the room or remove mold growth or dust concealed inside the air conditioner.
- If used in rooms where frying of food occurs, where heavy smokers congregate or in a humid room, the internal parts of the air conditioner (the heat exchanger or the exhaust fan) may become covered with dirt or mold which can't be removed.
- Inside drying operation is not performed in On/Off timer, Weekly timer and Comfort sleep if remote control is not in position to send signal to air conditioner.

# Care and cleaning

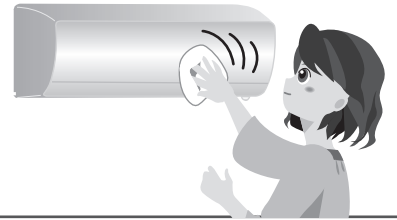

**Normal care :** Turn off power supply before checking or cleaning.

## Warning

- **Do not wash inside air conditioner yourself.**  
If washing inside the air conditioner is necessary, please request service from the supplying retail dealership. If the inside is washed incorrectly, parts damage may occur or if insulation of electrical parts is damaged by water leakage, electric shocks or fires are possible.

## Inspect air conditioner regularly to ensure efficient operation

### Indoor unit

**Wipe with a soft cloth.**

- Wipe with a soft cloth with warm water (less than 40 °C) and please dry well.

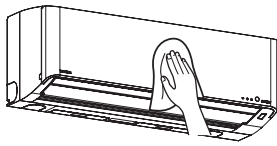

### Remote control

**Wipe with a soft cloth.**

- Do not wash with water. It may cause damage.

#### Notes

- Do not use alcohol, petroleum, thinners, glass cleaner or polishing powder. These may damage the product.
- Do not rub or touch for a long period with a chemical wipe. It may cause deterioration or stripping of materials.

### Air filter

After using about 2 weeks, please clean it. When the air filter is blocked, the efficiency of air conditioner may be decreased.

**Clean with a vacuum cleaner or wash in water.**

- When washing in water, please dry well.

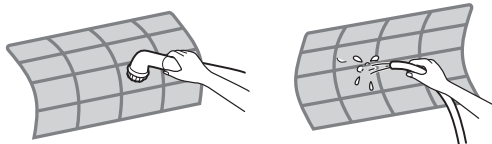

### How to remove air filter.

**1. Lift the front panel until it stops.**

**2. Raise handle of the lower air filter and pull out.**

- At the time of fixing; When replacing the air filter, insert it in the indoor unit and snap into place using the filter control guide and close the front panel.

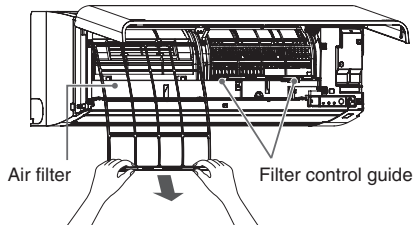

### How to open the front panel

**Pull the lower levers at the right and left side toward you and lift them up until fixed and stop.**

- ※ Beware an arm of the front panel might come off and fall.

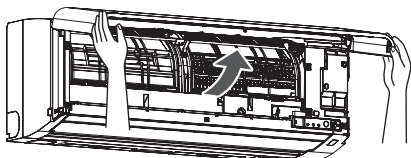

### How to remove the front panel

Pull and lift up front panel until it stops, move arms on left and right side to outward direction then pull toward you to remove front panel.

- ※ Beware a piece of the front panel might come off and fall.

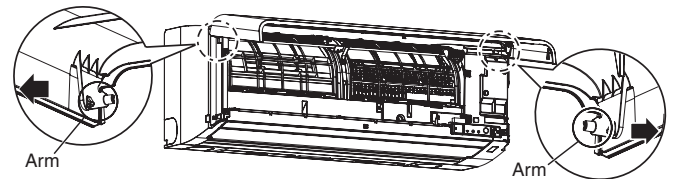

### How to attach the front panel

**Reverse the procedure to attach the front panel.**

Keep front panel horizontal and put both arms into guides.

Make sure both arms are inserted completely.

If the gap between main panel and front panel isn't even, remove and attach again.

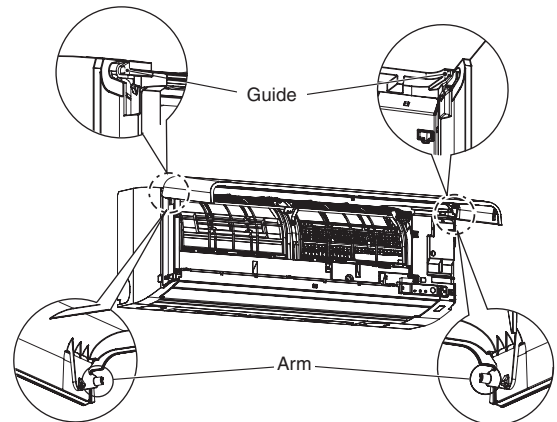

Main panel

Front panel

### How to close

Pull the front panel downward, push three portions on the upper side of air outlet to close the front panel.

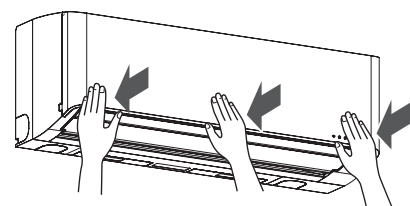

# Care and cleaning (continued)

## ⚠ Caution

- **When cleaning (or removing the front panel/air filter).**  
Be aware of an unstable support that may overturn and cause injury.
- **After washing the air filter in water, wipe off and dry it.**  
If moisture remains, it may cause the electric shock.
- **Do not touch metal part of the indoor unit in the state of removing the front panel.**  
It may cause the injury.

## Not in use for an extended period

- 1 Run ventilation and dry inside 3 or 4 times.**
  - The ventilation is operate air conditioner with high temperature setting.
- 2 Stop operation by remote control and disconnect the power supply.**
- 3 Air filter care.** ← Page 36
- 4 Pull out dry batteries of remote control.**
  - If leaving for a long time, there might be a leak and an electric discharge may result.

## Re-starting after extended off period

- 1 Is air filter not dirty? Confirm whether it is attached.**
- 2 Confirm whether surroundings of indoor/outdoor unit are not blocked.**
  - If blocked, performance may be impaired or may not function.
- 3 Put dry batteries into remote control.**
- 4 Turn on the power supply.**

## Regular check

- When using for a long time, may the water drainage become worse.
- Recommend maintenance by supplying retail dealership.
- Unpleasant odors may occur due to substances such as mold or dust.  
When the odor causes discomfort, washing the air conditioner is recommended.

### Notes

#### Washing the air conditioner

- Expertise is necessary when selecting the cleaning method and cleaner. If washing inside the air conditioner is necessary, please request service from the supplying retail dealership. ← Page 36

## Filter (optional).

Filter is an optional part by separate sale and can be attached in 2 pieces. Please purchase at supplying retail dealership.

### ■ How to install.

1. Open the front panel.
2. Remove the air filter.

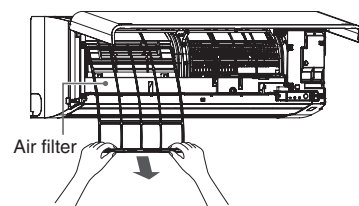

3. Install filter to the frame of the indoor unit.
4. Install air filter and close the front panel.

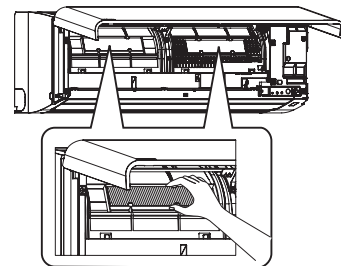

There are 2 places of frame of the indoor unit.

### ■ Replacing and care.

The exchange time depends on kind of filter.  
Consult the supplying retail dealership for replacement and care details.  
Replacement of each filter time of each filter is standard.  
When filter is full of dust, please change it promptly.

# When indoor unit lamp blinks

Turn off the power supply. Wait 30 seconds. Turn on the power supply and check the operation of the unit.

## If the lamp blinks again, inspection and repair is required

To repair quickly, check the status of the air conditioner according to the following procedure and inform (1) – (3) the supplying retail dealership.

- ① Problems with the air conditioner.
- ② Check code found by the remote control (See process below).
- ③ Blink status of the lamp in the display portion of the indoor unit

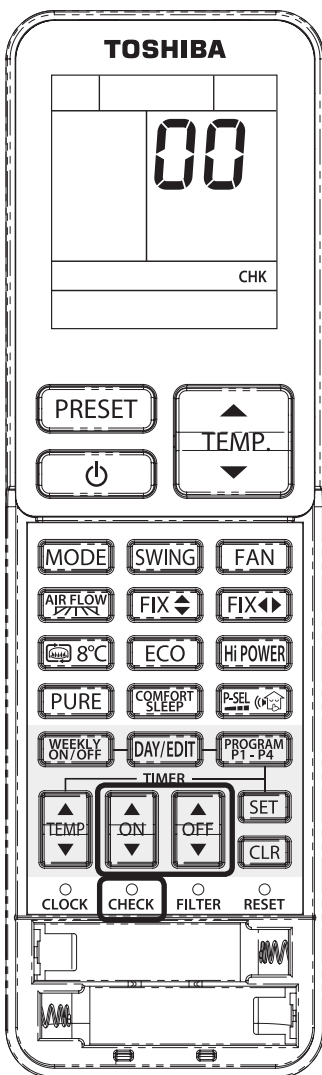

### 1 Press the CHECK button with the tip of a pencil to set the remote control to the service mode.

- Temperature display setting switches to 00.
- **CHK** is displayed.

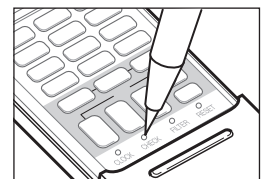

### 2 Press **ON** or **OFF**.

- **▲** is displayed in the remote control display.
- Press **ON** or **OFF** button.

If there is no fault with a code, the indoor unit will sound "Pi" once and the display of the remote control will change as follows :

→ 00 → 01 → 02 ... 1d → 1E → 33

- The TIMER indicator of the indoor unit will flash continuously. (5 times per 1 sec.)
- Check the unit with all 52 check codes ( 00 to 33 ) as shown in below table.

- Press **ON** or **OFF** button to move the check codes backward.

If there is a fault, the indoor unit will "Pi" for 10 seconds (Pi, Pi, Pi ...). Note the check code on the display of the remote control.

- The display will indicate a 2-digit alphanumeric code.
- All indicators on the indoor unit will flash. (5 times per 1 sec.)

### 3 Press **ON** to clear.

- Remote display returns to the display before the service mode. Check other codes by repeat the process ① - ③.

#### Notes

- Check codes may not be displayed depending on the kind of fault such as an electrical parts fault.
- If the check codes are checked when the lamp is not blinking, the correct error code may not be displayed.
- Do not disassemble or repair yourself. Consult the supplying retail dealership.

## Check Codes Table

Check codes not listed in the table may be detected.

Problem with indoor unit (including wiring fault).
00, 01, 04, 0C, 0d, 10, 11, 12
Problem with outdoor unit (including compressor and others).
02, 03, 07, 08, 14, 15, 17, 18, 19, 1A, 1b, 1C, 1d, 1E, 1F

Check codes consist of digits and letters.

5 → 5    6 → 6    A → A  
b → B    C → C    d → D

# Auto Restart

This product is designed so that after a power failure, it can restart automatically in the same operating mode as before the power failure.

The product was shipped with Auto Restart function in the off position. Turn it on as required.

## How to set the Auto Restart

- ① Press and hold the Temporary switch on the indoor unit for 3 seconds to set the operation (3 "Pi" sounds and OPERATION lamp blinks 5 times/sec for 5 seconds).
  - ② Press and hold the Temporary switch on the indoor unit for 3 seconds to cancel the operation (3 "Pi" sounds but OPERATION lamp does not blink).
- In case the ON timer or OFF timer is set, AUTO RESTART OPERATION does not activate.

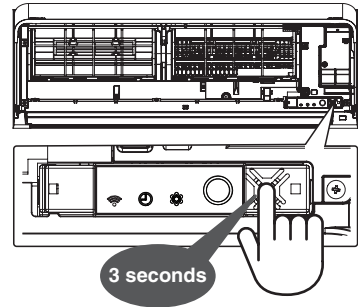

# Special points to consider

## If the remote control is not available

In case the remote control is misplaced, temporary Automatic operation is available from Temporary switch on the indoor unit.

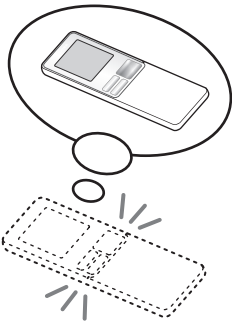

### ■ When operating

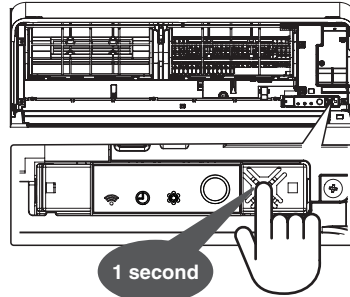

- Fully Automatic operation. (Temperature and air volume are set automatically).
- Operation lamp turns on.

### ■ To stop

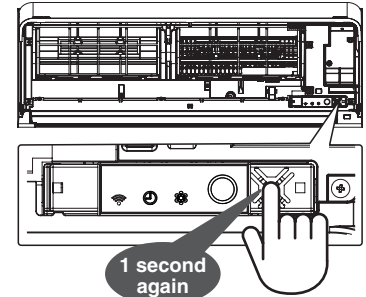

- Automatic cleaning is not operated.
- Operation lamp turns off.

## In the event 2 air conditioners are installed in close proximity

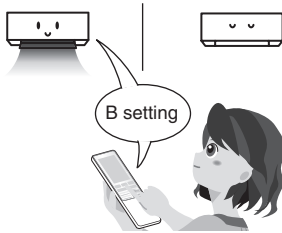

### A - B Selection

To separate remote control usage for each indoor unit in case 2 air conditioners are installed adjacent to each other.  
 ※ Indoor unit and remote control are set to A when shipped from the factory.

### How to set both the indoor unit and the remote control to B

- 1 Press Temporary switch for approx. 1 second to start automatic operation.
- 2 Point the remote control at the indoor unit.
- 3 Push and hold CHECK button on the Remote Control by the tip of the pencil. "00" will be shown on the display. (Picture 1)
- 4 Press MODE during pushing CHECK. "B" will show on the display and "00" will disappear and the air conditioner will turn OFF. The Remote Control B is memorized. (Picture 2)

**Note:** 1. Repeat above step to reset Remote Control to be A.  
 2. Remote Control A has not "A" display.  
 3. Default setting of Remote Control from factory is A.

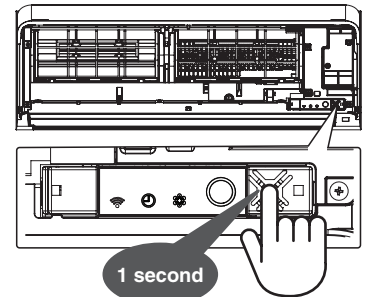
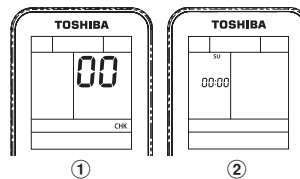

## Concern about the operating noise

Start the operation smoothly and reduce the operating noise.

Press for 20 seconds

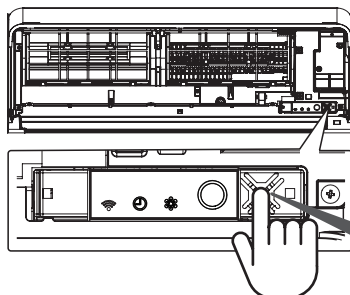
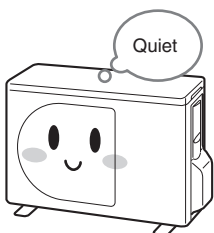

When setting is complete.

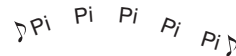



- Cooling or Heating starts after 10 seconds with a "Pi" sound. However, continue to press it. Setting completes when the "Pi" sounds 5 times and the operation lamp blinks.
- To cancel it, repeat the above operation (in this case, the operation lamp does not blink)



# These are not failures

In this case		Description and where to check
Operation and behavior of the air conditioner	Air conditioner does not work.	<ul style="list-style-type: none"> <li>● Is it immediately after the power supply is turned on? It takes 3 minutes for preparation. During this period, the compressor does not operate.</li> <li>● Is the power supply off? <a href="#">← Page 12</a></li> <li>● Has the fuse or breaker popped?</li> <li>● Is there a power failure?</li> <li>● Is it immediately after the operation stops? → To protect the equipment, it does not operate for 3 minutes.</li> <li>● Is the button on the remote control pressed while it is pointed at the Infrared signal receiver on the Indoor unit? <a href="#">← Page 12</a></li> <li>● Is Timer On selected? <a href="#">← Page 21</a></li> </ul>
	The air conditioner and heating system are weak (Stops when operating).	<ul style="list-style-type: none"> <li>● Is the air filter dirty?</li> <li>● Are temperature setting, air volume setting and air flow direction adjustment appropriate? <a href="#">← Page 14, 15, 18, 19</a></li> <li>● Has the unit operating for a long time while the air flow is set to “ ” or “ ”? <a href="#">← Page 18</a></li> <li>● Are the air inlet or outlet of the outdoor unit covered?</li> <li>● Is a window or door open?</li> <li>● Is it operating for Dry operation? <a href="#">← Page 16</a></li> <li>● Is it operating in ECO operation? <a href="#">← Page 31</a></li> <li>● Is it operating to Comfort sleep? <a href="#">← Page 20</a></li> <li>● Is the “Power selection” set to “75%” or “50%”? <a href="#">← Page 32</a></li> <li>● Is it off timer for Timer off or Comfort sleep function setting? <a href="#">← Page 20, 21</a></li> <li>● Protection may be activated due to an unreasonable electrical load caused by voltage variation or covering of the air inlet. Remove any obstructions and reset the circuit breaker after 30 seconds.</li> </ul>
	Air flow stops.	<ul style="list-style-type: none"> <li>● Air flow may stop during Heating operation.</li> </ul>
	It does not reach the set temperature.	<ul style="list-style-type: none"> <li>● It may not reach the set temperature depending on the indoor or outdoor conditions (It is caused by a large difference between set temperature and room temperature when the operation starts. Ambient temperature is also critical).</li> <li>● When the operation stops, the vertical direction louvers fully open once and then close.</li> </ul>
Appearance of vapor or condensation	Indoor unit Vapor appears.	<ul style="list-style-type: none"> <li>● Vapor may appear due to the rapidly cooled air in the room.</li> <li>● Vapor may appear due to condensed water on the heat exchanger, or the panel may become moist during cooling, dry mode, or inside drying.</li> </ul>
	Indoor unit Condensation appears.	
Outdoor unit	Outdoor unit Frost, water, or steam appears.	<ul style="list-style-type: none"> <li>● Are the vertical direction louvers closed or pointing downward? Condensation may form if operated for a long time in the downward rather than horizontal position during cooling or dry mode.</li> <li>● The outdoor unit may be covered with frost during heating.</li> <li>● This is because the melted frost turns to water or steam in order to improve heating efficiency.</li> <li>● Water may drip during cooling or dry mode. This is water condensed from the air settling on the cool piping.</li> </ul>
	Outdoor unit	
Odor or dirt	Bad odor in the room.	<ul style="list-style-type: none"> <li>● The odor in the walls, carpet, furniture or clothes may be due to natural air circulation.</li> </ul>

# These are not failures (continued)

In this case		Description and where to check
Operation lamp	Operation lamp (⏻) is blinking slowly.	<b>It is not a fault</b> <ul style="list-style-type: none"> <li>● For a power failure during operation (including Timer On setting), the lamp illuminates when the power is supplied again. When the button in the remote control is pressed once, the operation starts and the blinking changes to illuminate. Re-select the timer when the power resumes since the timer settings are cancelled during a power failure.</li> </ul>
	Operation lamp (⏻) or timer lamp (⏻) blinks rapidly (5 times per second). The lamp in the display of the indoor unit is dark.	
Remote control operation	Remote control transmission is not received by indoor unit	<b>Check again</b> <ul style="list-style-type: none"> <li>● Check the failure in accordance with the procedure "If the lamp in the indoor unit blinks". <a href="#">← Page 38</a></li> <li>● Is the "Indoor unit operation display lamp brightness set" to "Standard"? <a href="#">← Page 34</a></li> </ul>
	The vertical direction louvers do not move or move in a narrow range even when <b>FIX↔</b> <b>FIX↔</b> is pressed.	
	Setting temperature is not displayed even when  is pressed.	
If a noise is heard	Air conditioner does not stop operating even when  is pressed.	<b>Check again</b> <ul style="list-style-type: none"> <li>● Is the button on the remote control pressed while the transmission between remote control and receiving module? <a href="#">← Page 12</a></li> <li>● Is it immediately after the operation stops? (A signal is transmitted from the indoor unit to the remote control immediately after the operation stops) → Press the button again.</li> <li>● Is the direction of the batteries (+, -) correct? <a href="#">← Page 11</a></li> <li>● Are the batteries dead?</li> <li>● Does the "A-B switching" in the remote control match the indoor unit? <a href="#">← Page 40</a></li> <li>● Is timer set? <a href="#">← Page 21</a></li> <li>● Is the inside drying operation on?</li> <li>● Is it set to Plasma purifier only? <a href="#">← Page 17</a></li> <li>● Is inside drying operation on? <a href="#">← Page 35</a> Press  2 more times to stop the operation.</li> <li>● Noise of initial position setting of vertical direction louvers.</li> </ul>
	When the power turn on, start or stop the operation of air conditioner. When the air conditioner is operating.	
	Others	
	Sound comes from the plasma ion charger.	
	Air conditioner is operating.	
Indoor unit	<b>These are not failures</b> <ul style="list-style-type: none"> <li>● When the flow of refrigerant is switched, a sloshing noise may sound.</li> <li>● When parts expand or shrink as the temperature changes, a sloshing noise sounds.</li> <li>● When the refrigerant flows, noise of rustling sounds.</li> <li>● Hissing may sound if the outside wind is strong while the operation is stopped.</li> <li>● Bubbling noise from the drainage pipe is the noise from external air flowing into the room through the drainage pipe. It is caused when the ventilation fan is operated in an air tight room.</li> </ul>	
Outdoor unit	<b>Consult us</b> <p><b>For a failure of the plasma ion charger, consult the supplying retail dealership or the Toshiba Service Center.</b></p> <p>The plasma ion charger has high voltage poles. DO NOT inspect or repair yourself since these are dangerous.</p>	
	<b>These are not failures</b> <ul style="list-style-type: none"> <li>● Slosh is the noise of refrigerant flow.</li> </ul>	

**TOSHIBA**



1121450199