

TOSHIBA

AIR CONDITIONER (SPLIT TYPE)

Owner's Manual

R32

For commercial use

Indoor Unit

Model name:

<Compact 4-Way type>

RAV-HM301MUT-E

RAV-HM401MUT-E

RAV-HM561MUT-E

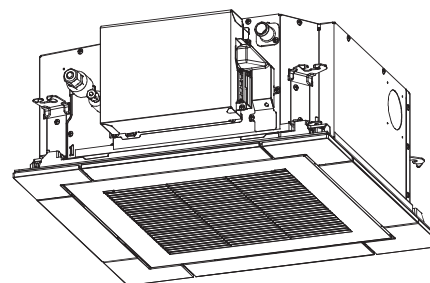

Original instruction

Thank you very much for purchasing TOSHIBA Air Conditioner.
 Please read this owner's manual carefully before using your Air Conditioner.
 • Be sure to obtain the "Owner's manual" and "Installation manual" from constructor (or dealer).
 • Request to constructor or dealer
 Please clearly explain the contents of the Owner's manual and hand over it.

ADOPTION OF R32 REFRIGERANT

This Air Conditioner has adopted a refrigerant HFC (R32) which does not destroy the ozone layer.

This appliance can be used by children aged from 8 years and above and persons with reduced physical, sensory or mental capabilities or lack of experience and knowledge if they have been given supervision or instruction concerning use of the appliance in a safe way and understand the hazards involved. Children shall not play with the appliance. Cleaning and user maintenance shall not be made by children without supervision.

Contents

1 Precautions for safety 3

2 Part names 6

3 Part names and functions of the remote controller 7

4 Operation 8

5 OFF timer operation 9

6 Adjustment of wind direction 9

7 Maintenance 10

8 Troubleshooting 11

9 Operations and performance 12

10 Installation 13

11 Specifications 13

Thank you for purchasing this Toshiba air conditioner.
 Please read carefully through these instructions that contain important information which complies with the "Machinery Directive 2006 / 42 / EC", and ensure that you understand them.
 After reading these instructions, be sure to keep them in a safe place together with the Owner's Manual and Installation Manual supplied with your product.

Generic Denomination: Air Conditioner



Definition of Qualified Installer or Qualified Service Person

The air conditioner must be installed, maintained, repaired and removed by a qualified installer or qualified service person. When any of these jobs is to be done, ask a qualified installer or qualified service person to do them. A qualified installer or qualified service person is an agent who has the qualifications and knowledge described in the table below.

Agent	Qualifications and knowledge which the agent must have
Qualified installer (*1)	<ul style="list-style-type: none"> The qualified installer is a person who installs, maintains, relocates and removes the air conditioners made by Toshiba Carrier Corporation. He or she has been trained to install, maintain, relocate and remove the air conditioners made by Toshiba Carrier Corporation or, alternatively, he or she has been instructed in such operations by an individual or individuals who have been trained and is thus thoroughly acquainted with the knowledge related to these operations. The qualified installer who is allowed to do the electrical work involved in installation, relocation and removal has the qualifications pertaining to this electrical work as stipulated by the local laws and regulations, and he or she is a person who has been trained in matters relating to electrical work on the air conditioners made by Toshiba Carrier Corporation or, alternatively, he or she has been instructed in such matters by an individual or individuals who have been trained and is thus thoroughly acquainted with the knowledge related to this work. The qualified installer who is allowed to do the refrigerant handling and piping work involved in installation, relocation and removal has the qualifications pertaining to this refrigerant handling and piping work as stipulated by the local laws and regulations, and he or she is a person who has been trained in matters relating to refrigerant handling and piping work on the air conditioners made by Toshiba Carrier Corporation or, alternatively, he or she has been instructed in such matters by an individual or individuals who have been trained and is thus thoroughly acquainted with the knowledge related to this work. The qualified installer who is allowed to work at heights has been trained in matters relating to working at heights with the air conditioners made by Toshiba Carrier Corporation or, alternatively, he or she has been instructed in such matters by an individual or individuals who have been trained and is thus thoroughly acquainted with the knowledge related to this work.
Qualified service person (*1)	<ul style="list-style-type: none"> The qualified service person is a person who installs, repairs, maintains, relocates and removes the air conditioners made by Toshiba Carrier Corporation. He or she has been trained to install, repair, maintain, relocate and remove the air conditioners made by Toshiba Carrier Corporation or, alternatively, he or she has been instructed in such operations by an individual or individuals who have been trained and is thus thoroughly acquainted with the knowledge related to these operations. The qualified service person who is allowed to do the electrical work involved in installation, repair, relocation and removal has the qualifications pertaining to this electrical work as stipulated by the local laws and regulations, and he or she is a person who has been trained in matters relating to electrical work on the air conditioners made by Toshiba Carrier Corporation or, alternatively, he or she has been instructed in such matters by an individual or individuals who have been trained and is thus thoroughly acquainted with the knowledge related to this work. The qualified service person who is allowed to do the refrigerant handling and piping work involved in installation, repair, relocation and removal has the qualifications pertaining to this refrigerant handling and piping work as stipulated by the local laws and regulations, and he or she is a person who has been trained in matters relating to refrigerant handling and piping work on the air conditioners made by Toshiba Carrier Corporation or, alternatively, he or she has been instructed in such matters by an individual or individuals who have been trained and is thus thoroughly acquainted with the knowledge related to this work. The qualified service person who is allowed to work at heights has been trained in matters relating to working at heights with the air conditioners made by Toshiba Carrier Corporation or, alternatively, he or she has been instructed in such matters by an individual or individuals who have been trained and is thus thoroughly acquainted with the knowledge related to this work.





■ Meanings of symbols displayed on the air conditioner

These safety cautions describe important matters concerning safety to prevent injury to users or other people and damages to property. Please read through this manual after understanding the contents below (meanings of indications), and be sure to follow the description.





Indication	Meaning of Indication
 WARNING	Text set off in this manner indicates that failure to adhere to the directions in the warning could result in serious bodily harm (*1) or loss of life if the product is handled improperly.
 CAUTION	Text set off in this manner indicates that failure to adhere to the directions in the caution could result in slight injury (*2) or damage (*3) to property if the product is handled improperly.

- *1: Serious bodily harm indicates loss of eyesight, injury, burns, electric shock, bone fracture, poisoning, and other injuries which leave aftereffect and require hospitalization or long-term treatment as an outpatient.
 *2: Slight injury indicates injury, burns, electric shock, and other injuries which do not require hospitalization or long-term treatment as an outpatient.
 *3: Damage to property indicates damage extending to buildings, household effects, domestic livestock, and pets.

MEANINGS OF SYMBOLS DISPLAYED ON THE UNIT

	WARNING (Risk of fire)
	Read the OWNER'S MANUAL carefully before operation.
	Service personnel are required to carefully read the OWNER'S MANUAL and INSTALLATION MANUAL before operation.
	Further information is available in the OWNER'S MANUAL, INSTALLATION MANUAL, and the like.

Warning indications on the air conditioner unit

Warning indication	Description		
 <table border="1"> <tr> <td>WARNING</td> </tr> <tr> <td>ELECTRICAL SHOCK HAZARD Disconnect all remote electric power supplies before servicing.</td> </tr> </table>	WARNING	ELECTRICAL SHOCK HAZARD Disconnect all remote electric power supplies before servicing.	WARNING ELECTRICAL SHOCK HAZARD Disconnect all remote electric power supplies before servicing.
WARNING			
ELECTRICAL SHOCK HAZARD Disconnect all remote electric power supplies before servicing.			
 <table border="1"> <tr> <td>WARNING</td> </tr> <tr> <td>Moving parts. Do not operate unit with grille removed. Stop the unit before the servicing.</td> </tr> </table>	WARNING	Moving parts. Do not operate unit with grille removed. Stop the unit before the servicing.	WARNING Moving parts. Do not operate unit with grille removed. Stop the unit before the servicing.
WARNING			
Moving parts. Do not operate unit with grille removed. Stop the unit before the servicing.			
 <table border="1"> <tr> <td>CAUTION</td> </tr> <tr> <td>High temperature parts. You might get burned when removing this panel.</td> </tr> </table>	CAUTION	High temperature parts. You might get burned when removing this panel.	CAUTION High temperature parts. You might get burned when removing this panel.
CAUTION			
High temperature parts. You might get burned when removing this panel.			
 <table border="1"> <tr> <td>CAUTION</td> </tr> <tr> <td>Do not touch the aluminum fins of the unit. Doing so may result in injury.</td> </tr> </table>	CAUTION	Do not touch the aluminum fins of the unit. Doing so may result in injury.	CAUTION Do not touch the aluminum fins of the unit. Doing so may result in injury.
CAUTION			
Do not touch the aluminum fins of the unit. Doing so may result in injury.			
 <table border="1"> <tr> <td>CAUTION</td> </tr> <tr> <td>BURST HAZARD Open the service valves before the operation, otherwise there might be the burst.</td> </tr> </table>	CAUTION	BURST HAZARD Open the service valves before the operation, otherwise there might be the burst.	CAUTION BURST HAZARD Open the service valves before the operation, otherwise there might be the burst.
CAUTION			
BURST HAZARD Open the service valves before the operation, otherwise there might be the burst.			

1 Precautions for safety

The manufacturer shall not assume any liability for the damage caused by not observing the description of this manual.

WARNING

General

- Carefully read Owner's Manual before starting the air conditioner. There are many important things to keep in mind for daily operation.
- Ask for installation to be performed by the dealer or a professional. Only a Qualified installer (*1) is able to install an air conditioner. If a non-qualified person installs an air conditioner, it may result in problems such as fire, electric shock, injury, water leakage, noise and vibration.
- Do not use any refrigerant different from the one specified for complement or replacement. Otherwise, abnormally high pressure may be generated in the refrigeration cycle, which may result in a failure or explosion of the product or an injury to your body.
- Do not install the air conditioner in a place where the operation sound of the outdoor unit may cause a disturbance. (Especially at the boundary line with a neighbor, install the air conditioner while considering the noise.)
- This appliance is intended to be used by expert or trained users in shops, in light industry, or for commercial use by lay persons.

Transportation and storage

- To transport the air conditioner, wear shoes with protective toe caps, protective gloves, and other protective clothing.
- To transport the air conditioner, do not take hold of the bands around the packing carton. You may injure yourself if the bands should break.
- Before stacking the packing cartons for storage or transportation, heed the precautions written on the packing cartons. Failure to heed the precautions may cause the stack to collapse.
- The air conditioner must be transported in stable condition. If any part of the product broken, contact your dealer.
- When the air conditioner must be transported by hand, carry it by two or more people.

Installation

- Only a Qualified installer (*1) or Qualified service person (*1) is allowed to carry out the electrical work of the air conditioner. Under no circumstances must this work be done by an unqualified individual since failure to carry out the work properly may result in electric shocks and/or electrical leaks.
- After the installation work has been completed, have the installer explain about the circuit breaker positions. In the event that trouble has occurred in the air conditioner, set the circuit breaker to the OFF position, and contact a service person.
- If the unit is installed in a small room, take appropriate measures to prevent the refrigerant from exceeding the limit concentration even if it leaks. Consult the dealer from whom you purchased the air conditioner when you implement the measures. Accumulation of highly concentrated refrigerant may cause an oxygen deficiency accident.
- Do not install the air conditioner in a location that may be subject to a risk of expire to a combustible gas. If a combustible gas leaks and becomes concentrated around the unit, a fire may occur.
- Use the company-specified products for the separately purchased parts. Use of non-specified products may result in fire, electric shock, water leakage or other trouble. Have the installation performed by a professional.
- Confirm that earthing is performed correctly.

Operation

- Before opening the intake grille of the indoor unit or service panel of the outdoor unit, set the circuit breaker to the OFF position. Failure to set the circuit breaker to the OFF position may result in electric shocks through contact with the interior parts. Only a Qualified installer (*1) or Qualified service person (*1) is allowed to remove the intake grille of the indoor unit or service panel of the outdoor unit and do the work required.
- Inside the air conditioner are high-voltage areas and rotating parts. Due to the danger of electric shocks or of your fingers or physical objects becoming trapped in the rotating parts, do not remove service panel of the outdoor unit. When work involving the removal of these parts is required, contact a Qualified installer (*1) or a Qualified service person (*1).
- Do not move or repair any unit by yourself. Since there is high voltage inside the unit, you may get electric shock when removing the cover and main unit.

-
- Use of a stand more than 50 cm high to clean the filter of the indoor unit or to carry out other such jobs constitutes working at heights. Due to the danger of falling off the stand and injuring yourself while working at heights, this kind of work should not be done by unqualified individuals. When this kind of work must be carried out, do not do it yourself but ask a qualified installer or a qualified service person to do it for you.
 - Do not touch the aluminum fin of the outdoor unit. You may injure yourself if you do so. If the fin must be touched, do not touch it yourself but contact a qualified installer or a qualified service person.
 - Do not climb onto or place objects on top of the outdoor unit. You may fall or the objects may fall off of the outdoor unit and result in injury.
 - Do not place any combustion appliance in a place where it is directly exposed to the wind of air conditioner, otherwise it may cause imperfect combustion.
 - When the air conditioner is operated with a combustion appliance in the same place, ventilate the room sufficiently. Poor ventilation causes oxygen shortage.
 - When the air conditioner is used in a closed room, sufficiently ventilate the room. Poor ventilation causes oxygen shortage.
 - Do not expose your body to cool air directly for a long time and do not cool yourself excessively. Doing so may result in deteriorated physical condition and ill health.
 - Do not insert your finger or a stick into the air intake or discharge. Doing so may result injury as the fan is rotating at high speed inside the unit.
 - Consult the shop where you purchased the air conditioner if air conditioning (cooling and heating) is not performed properly as a refrigerant leakage may be the cause. Confirm the repair details with a Qualified service person (*1) when the repair includes additional charging of the refrigerant.
 - Stop running the air conditioner and turn off the breaker before cleaning. Otherwise, injury may result as the fan is rotating at high speed inside the unit.

Repairs

- When you have noticed that some kind of trouble (such as when a check display has appeared, there is a smell of burning, abnormal sounds are heard, the air conditioner fails to cool or heat or water is leaking) has occurred in the air conditioner, do not touch the air conditioner yourself but set the circuit breaker to the OFF position, and contact a qualified service person. Take steps to ensure that the power will not be turned on (by marking “out of service” near the circuit breaker, for instance) until qualified service person arrives. Continuing to use the air conditioner in the abnormal status may cause mechanical problems to escalate or result in electric shocks, etc.
- If the fan grille is damaged, do not approach the outdoor unit but set the circuit breaker to the OFF position, and contact a Qualified service person (*1) to have the repairs done. Do not set the circuit breaker to the ON position until the repairs are completed.
- If you have discovered that there is a danger of the indoor unit’s falling, do not approach the indoor unit but set the circuit breaker to the OFF position, and contact a Qualified installer (*1) or a Qualified service person (*1) to refit the unit. Do not set the circuit breaker to the ON position until the unit has been refitted.
- If there is a danger of the outdoor unit’s toppling over, do not approach the outdoor unit but set the circuit breaker to the OFF position, and contact a Qualified installer (*1) or a Qualified service person (*1) to have the improvements or refitting done. Do not set the circuit breaker to the ON position until the improvements or refitting is completed.
- Do not customize the unit. Doing so may result in fire, electric shock or other trouble.

Relocation

- When the air conditioner is to be relocated, do not relocate it yourself but contact a Qualified installer (*1) or a Qualified service person (*1). Failure to relocate the air conditioner properly may result in electric shocks and/or a fire.

(*1) Refer to the “Definition of Qualified Installer or Qualified Service Person”.

⚠ CAUTION

Installation

- Certainly lay the drain hose for perfect draining. Improper drainage may cause flooding in the house and getting furniture wet.
- Connect the air conditioner to an exclusive power supply of the rated voltage, otherwise the unit may break down or cause a fire.
- Confirm that the outdoor unit are fixed on the base. Otherwise, falling down of the units or other accidents may occur.
- Do not install the air conditioner in place where steam is generated, or in place near the humidifier etc. Dew may form in the parts built in the unit, causing trouble of the unit.











Operation

- Do not use this air conditioner for special purpose such as preserving food, precision instruments, art objects, breeding animals, car, vessel.
- Do not touch any switches with wet finger, otherwise you may get an electric shock.
- If the air conditioner will not be used for a considerably long time, turn off the main switch or the circuit breaker, for safety.
- To make the air conditioner operate in its original performance, operate it within the range of the operating temperature specified in the instructions. Otherwise it may cause a malfunction, or water leak from the unit.
- Prevent any liquid from falling into the remote controller. Do not spill juice, water or any kind of liquid.
- Do not wash the air conditioner. Doing so may result in electric shock.
- Check whether the installation base and other equipment have become deteriorated after being used for a long time. Leaving them such condition may result in the unit's falling down and causing injury.
- Do not leave flammable sprays or other flammable materials near the air conditioner, and do not spray flammable aerosol directly to the air conditioner. They may catch fire.
- Stop running the air conditioner and turn off the breaker before cleaning.
Otherwise, injury may result as the fan is rotating at high speed inside the unit.

- Ask for cleaning of the air conditioner to be performed by the dealer. Cleaning the air conditioner in an improper manner may cause damage to plastic parts, insulation failure of electric parts or other parts, and result in a malfunction. In the worst case, it may result in water leakage, electric shock, smoke emission or fire.
-

Information on the transportation, handling and storage of the carton

Examples of indication on the carton

Symbol	Description	Symbol	Description
	Keep dry	 DO NOT DROP	Do not drop
 FRAGILE	Fragile	 DO NOT LAY DOWN	Do not lay down
 11 cartons	Stacking height (12 cartons can be stacked in this case)		Do not step
	This side up		Do not drop (corner)
	Handle with care		Do not roll

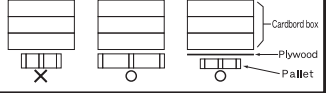
Other cautions	Description
 <div style="border: 1px solid black; padding: 5px; display: inline-block;"> <p>Caution</p> <p>Injury possibility. Don't handle with packing band, or may get injured in case of broken band.</p> </div>	<p>CAUTION</p> <p>Injury possibility. Don't handle with packing band, or may get injured in case of broken band.</p>
<p>Stacking notice.</p> <p>In case that cardboard boxes protrude out of pallet when stacking, lay a 10mm thick plywood over the pallet.</p> 	<p>Stacking notice.</p> <p>In case that cardboard boxes protrude out of pallet when stacking. Lay a 10 mm thick plywood over the pallet.</p>

2 Part names

Indoor unit

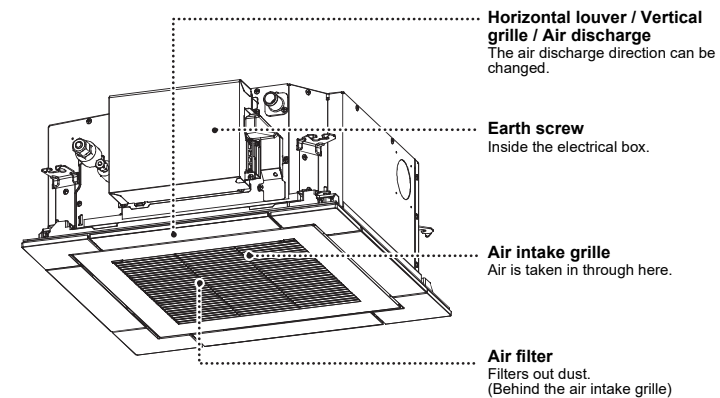

3 Part names and functions of the remote controller

Remote controller model name: RBC-ASCU1*

LCD back-light lights for 15 seconds during remote controller operation.

All indicators are displayed in the display example below.

Actually, only the selected options will be displayed.

Operations

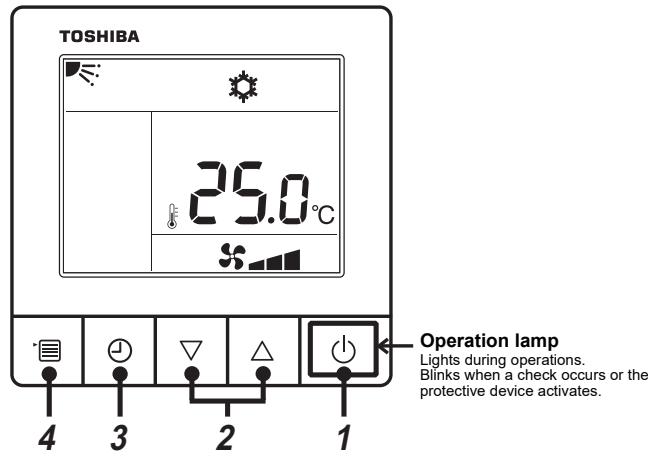

- 1 ON/OFF button**
Turns on the unit when pushed, and turns off when pushed again.
- 2 Setting button**
Sets setting temperature at the normal mode.
Changes each setting at the Operation mode, the Fan speed mode or the Wind direction mode.
- 3 OFF timer button**
Setting the OFF timer.
- 4 Menu button**
Selects the Operation mode select, the Fan speed select or the Wind direction select.
Each time you push the button, indicator is displayed as followings.
 - The Fan speed select or the Wind direction select is not displayed depending on indoor unit models.

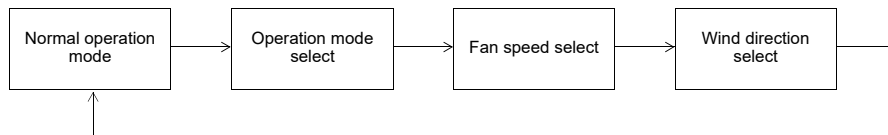

Indicators

All icons on the display are shown for this explanation. Operations are not accepted when "SETTING" is flashing.

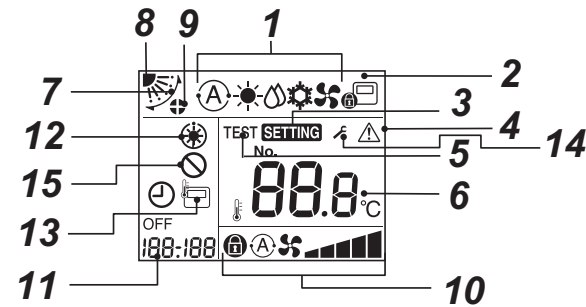

- 1 Operation mode indicator**
Indicates the operation mode selected.
- 2 Central control indicator**
Displayed when the air conditioner is controlled centrally and used with central control devices such as the central remote controller.
If the use of the remote controller is prohibited by the central control, the central control icon blinks when the ON/OFF, MODE, or TEMP. button on the remote controller is pushed, and the buttons do not function.
(Settings that can be configured on the remote controller differ depending on the mode of the central control. For details, read the Owner's Manual of the central remote controller.)
- 3 Setting indicator**
Indicates that the model is being checked automatically after a breaker is thrown or some other occurrence.
- 4 Service indicator**
Displayed while the protective device works or a check occurs.
- 5 Test run indicator**
Displayed during test run.
- 6 Temperature setting indicator**
The selected set temperature is displayed.
- 7 Swing indicator**
Displayed during up/down movement of the louver.
- 8 Louver position indicator**
Indicates the louver position.
- 9 Louver lock indicator**
Displayed when there is a louver-locked unit.
- 10 Fan speed indicator**
Indicates the selected fan speed

Auto	
Low	
Low +	
Medium	
Medium +	
High	
Fix	
- 11 OFF timer indicator**
When a trouble occurs, a check code is displayed.
- 12 Pre-heat indicator**
Displayed when the heating mode is energized or defrost cycle is initiated.
While this indication is displayed, the indoor fan stops or operate in fan mode.
- 13 Remote controller sensor indicator**
Displayed while the sensor of the remote controller is used.
- 14 Notice display**
Displayed while notice code occurs.
For details, contact your dealer (distributor).
- 15 No function display**
Displayed when the function requested is not available on that model.

4 Operation

When you use the air conditioner for the first time or change the settings, follow the procedures below. From next time, pushing the ON/OFF button starts running of the air conditioner with the chosen settings.

■ Standby

Operations are not accepted when "SETTING" is blinking.

REQUIREMENT

- Keep the power switch turned on during use.
- When you resume using the air conditioner after a long period of disuse, turn on the power switch at least 12 hours before starting running.
- When the power is turned on, it takes about 1 minute before the remote controller becomes operable. This is not a malfunction.

■ Running operation

Some operation modes are not available depending on the type of indoor unit.

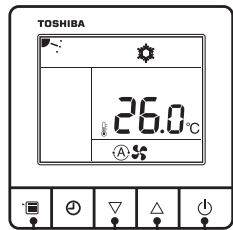

Menu button Setting button ON/OFF button

1 ON/OFF button

Push this button to light the operation lamp and start operations.

When heating

- The heated air comes out after a 3 to 5 minutes of pre-heating with the indoor fan kept turned off.

2 Select the operation mode

Push the Menu button several times to select the operation mode.

- The current operation mode flashes. Each time you push the setting button, the operation mode and its icon change in the following order:

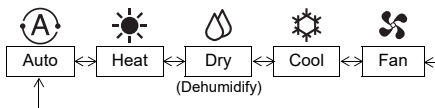

- If you do not push any button for 30s, the operation mode finishes.

3 Select the fan speed

Push the Menu button several times to select the fan speed mode.

- The current fan speed indicator flashes. Each time you push the setting button, the fan speed mode and its indication change in the following order:

- A selectable fan speed differs depending on indoor units to be connected.
- "Auto" cannot be selected at the Fan mode.
- If you do not push any button for 30s, the fan speed mode finishes.

4 Select the temperature

Push the setting button to adjust the temperature.

- The temperature setting range is 18.0°C to 29.0°C.
- The temperature can be set in steps of 0.5°C.

NOTE

Auto Changeover

- When in Auto Mode, the unit selects the operating mode (cooling, heating or fan only) based on the user set point temperature.
- If the Auto mode is uncomfortable, you can select the desired conditions manually.

Cooling

- If there is a demand for cooling, unit will start approximately 1 minute after mode is selected.
- When the room temperature reaches the set temperature, the outdoor unit stops and the indoor unit fan runs at extremely low speed.

Heating

- If there is a demand for heating, unit will start approximately 3 to 5 minutes after the mode is selected.
- After the heating operation has stopped, fan may continue to run for approx. 30 seconds.
- When the room temperature reaches the set temperature, the outdoor unit stops and the indoor unit fan runs at extremely low speed.
- During defrost operation, the fan stops so that cool air is not discharged. ("Pre-heat" is displayed.)

When restarting the operation after stop

When the unit is attempted to restart immediately after it was stopped, the unit can not start for approx. 3 minutes this is to protect the compressor.

■ 8°C Operation (For object pre-heating)

The air conditioner can control the heating temperature to about 8°C in the heating mode.

The 8°C heating operation requires settings with the wired remote controller. Ask the installer or dealer for the settings according to the installation manual of the indoor unit.

Start

- 1 Set the displayed temperature to 18°C in the heating mode by pushing [▽] setting button.
- 2 Set the displayed temperature to 8°C by pushing [▽] setting button for at least four seconds.

Stop

- 1 Set the displayed temperature to 18°C by pushing [△] setting button.
 - The air conditioner returns to the normal Heat mode. Select a desired temperature and operation mode.

NOTE

- The discharged air temperature is lower than that in the normal heating operation.
- The room temperature may not be heated evenly depending on the remote controller installation location.
- The room temperature may not reach 8°C depending on the room size or the installation conditions.
- Setting for fan speed is available during the 8°C heating operation.
 - The 8°C heating operation is cancelled in the following cases.
 - When operation is stopped with ON/OFF button.
 - When another operation mode is selected.
 - When temperature setting or operation mode is changed or operation is started / stopped by the wireless remote controller or the central control remote controller.
- When this operation mode is used, observe proper operating hours and periodic maintenance by service staff is recommended.

5 OFF timer operation

OFF timer: The indoor unit stops when the set time is reached.

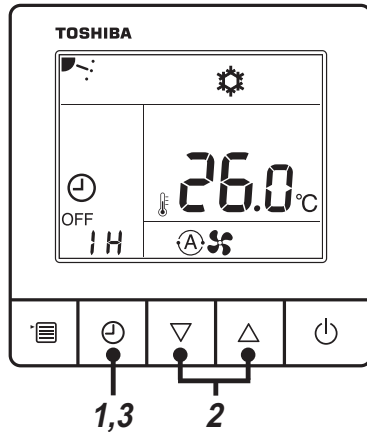

1 OFF timer button

Push the OFF timer button during air conditioning operation.
 • “⌚” and “OFF” light and “SETTING” and timer indicator flash.

2 Select the OFF timer time

Push the setting button to set the time.
 • The OFF timer time can be set to 0.5 h (30 min), 1 h, 2 h, ... up to 24 h.
 • If you do not push any button for 30s, the OFF timer setting will be cancelled.

3 Push the OFF timer button

“SETTING” disappears, the timer indicator changes from flashing to lighting, and the OFF timer starts.
 • The timer indicator on the OFF timer operation is displayed with countdown.

■ Cancelling the timer

1 Push the OFF timer button

The timer indicator disappears.

NOTE

Even if air conditioning is turned on or off with the ON/OFF button during OFF timer operation, the OFF timer operation continues.

6 Adjustment of wind direction

To improve the cooling / heating performance, change the louver angle for each operation.
Air characteristics: Cool air falls, and warm air rises.

⚠ CAUTION

Point the louver horizontally during cooling
 If pointing downward for cooling, dew may form on the surface of the air discharge or louver and may drop down.

NOTE

- If pointing horizontally for heating, the room temperature may be uneven.
- Do not handle the louver manually. Doing so may cause a failure. Use the remote controller to adjust the angle.

To set the louver direction and auto swing

1 Push the Menu button several times and select the wind direction mode to blink the wind direction.

2 Push the setting button several times to display the louver direction as shown in the figure below.

- If you do not push any button for 30s, the wind direction mode finishes.

▼ For heating

The louver can be adjusted to six steps.
 Point the louver downward. If not pointing downward, hot air may not reach the floor.

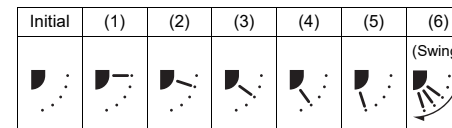

Operation mode	Available directions
HEAT, FAN	(1) ↔ (2) ↔ (3) ↔ (4) ↔ (5) ↔ (6)

▼ For cooling

The louver can be adjusted to four steps.
 Point the louver horizontally. If pointing downward, dew may form on the surface of the air discharge port and may drop down.

If a louver lock setup is carried out in the position of (1), fan speed will be restricted for prevention of ceiling contamination.

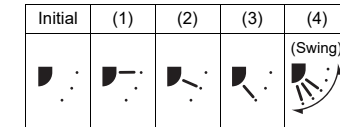

Operation mode	Available directions
COOL, DRY	(1) ↔ (2) ↔ (3) ↔ (4)

▼ For fan

The louver can be adjusted to six steps.
 Select a wind direction.

■ Auto swing

The SWING indicator is displayed and the louver begins swinging.

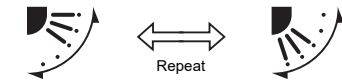

▼ When cooling

Point the louver horizontally.

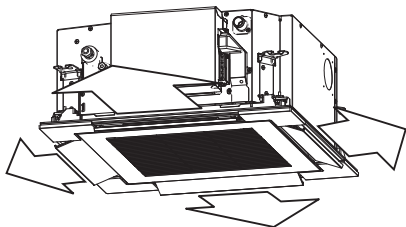

▼ When heating

Point the louver downward.

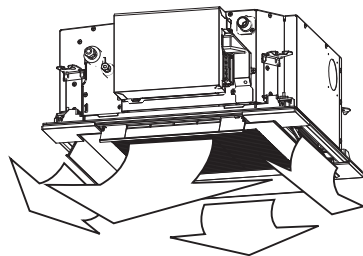

- The louver automatically closes when running is stopped.
- In pre-heating mode, the louver points upward. The swing indication appears on the remote controller even in pre-heating mode, but the actual swing starts only after pre-heating is complete.

NOTE

- When stopped, the louver closes automatically.
- The louver automatically becomes horizontal or closed at the start of heating operation, defrosting operation, or when the set temperature becomes the same as room temperature. If you set the swing or wind direction at this time, the remote controller display will be the setting, but the louver will not move. When the normal heating operation that blows warm air is started, the louver will be in the set wind direction.
- When the defrosting operation is performed during heating, the louver automatically closes to reduce the cold air falling from the indoor unit.
- If the heating operation is performed less than 12 hours after the circuit breaker is turned on when the outside temperature is low, the louver may automatically close immediately after the start of heating operation to reduce the loss of cold air.

Information

The following functions require a connection with the RBC-AMTU*** and RBC-AMSU*** remote controller. For details, consult the dealer where you purchased this product.

- Individual unit selection during group operation
- Individual setting of louver position (wind direction)
- Swing type setting
- Louver lock (no swing) setting

7 Maintenance

⚠ WARNING

Cleaning the air filter and other parts of the air filter involves dangerous work in high places, so be sure to have a qualified installer or qualified service person to do it. Do not attempt it by yourself.

⚠ CAUTION

Do not push buttons with wet hands. Doing so may result in electric shock.

Cleaning the air filters

- When the filter indicator is displayed on the remote controller, clean the air filters. (Only for RBC-AMTU*** and RBC-AMSU*** remote controllers.)
- Clogged filters may lower the cooling and heating performance.

When the unit will not be used for a long time

1. Perform the fan operation for a couple of hours to dry inside.
2. Stop the air conditioner with the remote controller and turn off the circuit breaker.
3. Clean the air filters and reinstall them.

Before the cooling season

Clean the drain pan

- Contact the dealer where you purchased the product. (Drain does not work if the drain pan or vent is clogged. In some cases the drain may overflow and wet the wall or floor. Be sure to clean the drain pan before the cooling season.)

Check periodically

- If the unit is used for a long time, parts may deteriorate and cause malfunction or bad drainage of dehumidified water depending on the heat, humidity, or dust.
- In addition to the usual maintenance, it is recommended that you have the unit checked and maintained by the dealer where you purchased it.

NOTE

For environmental conservation, it is strongly recommended that the indoor and outdoor units of the air conditioner in use be cleaned and maintained regularly to ensure efficient operation of the air conditioner. When the air conditioner is operated for a long time, periodic maintenance (once a year) is recommended. Furthermore, regularly check the outdoor unit for rust and scratches, and remove them or apply rustproof treatment, if necessary. As a general rule, when an indoor unit is operated for 8 hours or more daily, clean the indoor unit and outdoor unit at least once every 3 months. Ask a professional for this cleaning / maintenance work. Such maintenance can extend the life of the product though it involves the owner's expense. Failure to clean the indoor and outdoor units regularly will result in poor performance, freezing, water leakage, and even compressor failure.

Maintenance List

Part	Unit	Check (visual / auditory)	Maintenance
Heat exchanger	Indoor / outdoor	Dust / dirt clogging, scratches	Wash the heat exchanger when it is clogged.
Fan motor	Indoor / outdoor	Sound	Take appropriate measures when abnormal sound is generated.
Filter	Indoor	Dust / dirt, breakage	<ul style="list-style-type: none"> • Wash the filter with water when it is contaminated. • Replace it when it is damaged.
Fan	Indoor	<ul style="list-style-type: none"> • Vibration, balance • Dust / dirt, appearance 	<ul style="list-style-type: none"> • Replace the fan when vibration or balance is terrible. • Brush or wash the fan when it is contaminated.
Air intake / discharge grilles	Indoor / outdoor	Dust / dirt, scratches	Fix or replace them when they are deformed or damaged.
Drain pan	Indoor	Dust / dirt clogging, drain contamination	Clean the drain pan and check the downward slope for smooth drainage.
Ceiling panel, louvers	Indoor	Dust / dirt, scratches	Wash them when they are contaminated or apply repair coating.
Exterior	Outdoor	<ul style="list-style-type: none"> • Rust, peeling of insulator • Peeling / lift of coat 	Apply repair coating.

8 Troubleshooting

Check the points described below before requesting repair.

	Symptom	Cause
It is not a malfunction.	Outdoor unit <ul style="list-style-type: none"> • White, misty, cold air or water comes out • Sometimes the noise of air leaking is heard. • A noise is heard when the power is turned on. 	<ul style="list-style-type: none"> • The fan of the outdoor unit is automatically stopped and defrosting is performed. • The solenoid valve works when defrosting starts or stops. • The outdoor unit is preparing for running.
	Indoor unit <ul style="list-style-type: none"> • Sometimes a swishing is heard. • A clacking sound is heard. • Discharged air smells unusual. • Louvers close automatically during heating 	<ul style="list-style-type: none"> • When the unit starts running, during operation, or immediately after the unit stops running, a sound such as water flowing may be heard, or the operation sound may become louder for a couple of minutes immediately after the unit starts running. This is the sound of the refrigerant flowing or the dehumidifier draining. • This is a sound generated when the heat exchanger, etc. expands and contracts slightly due to temperature change. • Various smells from the walls, carpet, clothes, cigarette, cosmetics, etc. adhere to the air conditioner. • In the following cases, the louvers close automatically to reduce the cold air falling from the indoor unit. • When defrosting during heating operation. • Immediately after starting heating operation less than 12 hours after turning on the circuit breaker when the outside temperature is low.
Check again.	The unit does not run	<ul style="list-style-type: none"> • Has a blackout occurred? • Has the circuit breaker blown? • Has the protective device been activated? (The operation indicator and  on the remote controller are blinking.)
	The room does not cool down or warm up.	<ul style="list-style-type: none"> • Is the air intake or discharge of the outdoor unit clogged? • Is a door or window open? • Is the air filter clogged with dust? • Is the air volume set to "Low"? Or is the operation mode set to "Fan"? • Is the setup temperature appropriate?

If there is something unusual even after checking the above, stop running the unit, turn off the circuit breaker, and inform the dealer where you purchased the product of the product number and symptom. Do not attempt to repair the unit by yourself as doing so is dangerous. If the check indicator (E0 1, F0 1, HQ 1, etc.) is displayed on the remote controller LCD, inform the dealer of its content as well.

If any of the following occur, stop running the unit immediately, turn off the circuit breaker, and contact the dealer where you purchased the product.

- The switch does not work properly.
- The circuit breaker often blows out.
- You unintentionally put a foreign object or water inside.
- The unit cannot be run even after the cause of the protective device activation is removed.
- Other unusual conditions are found.

Confirmation and check

If a problem occurs with the air conditioner, the OFF timer indicator alternately shows the check code and the indoor Unit No. in which the problem occurred.

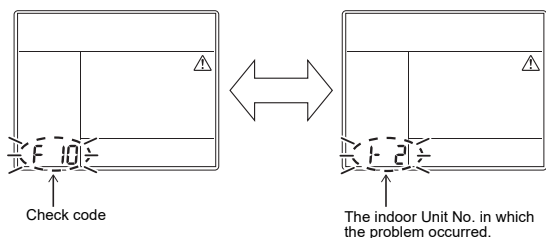

Troubleshooting history and confirmation

You can check the troubleshooting history with the following procedure if a problem occurs with the air conditioner. (The troubleshooting history records up to 4 incidents.)

You can check it during operation or when operation is stopped.

- If you check the troubleshooting history during OFF timer operation, the OFF timer will be cancelled.

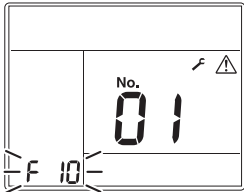
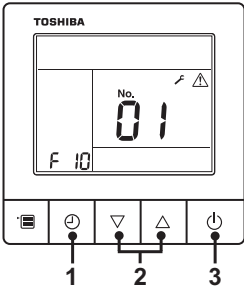
Procedure	Description of operation
1	<p>Push the OFF timer button for over 10 seconds and the indicators appear as an image indicating the troubleshooting history mode has been entered. If [Service check] is displayed, the mode enters in the troubleshooting history mode.</p> <ul style="list-style-type: none"> [01: Order of troubleshooting history] appears in the temperature indicator. The OFF timer indicator alternately shows the [check code] and the [indoor Unit No.] in which the problem occurred. 
2	<p>Each time the setting button is pushed, the recorded troubleshooting history is displayed in sequence. The troubleshooting history appears in order from [01] (newest) to [04] (oldest).</p> <p>CAUTION</p> <p>In the troubleshooting history mode, DO NOT push the Menu button for over 10 seconds, doing so deletes the entire troubleshooting history of the indoor unit.</p> 
3	<p>After you have finished checking, push the ON/OFF button to return to the regular mode.</p> <ul style="list-style-type: none"> If the air conditioner is operating, it remains operated even after the ON/OFF button has been pushed. To stop its operation, push the ON/OFF button again.

9 Operations and performance

Check before running

- Check whether the earth wire is cut or disconnected.
- Check whether the air filter is installed.
- Turn on the circuit breaker 12 hours or more before starting operation.

3 minutes protection function

3-minutes protection function prevents the air conditioner from starting for initial 3 minutes after the main power switch / circuit breaker is turned on for re-starting the air conditioner.

Power failure

- Power failure during operation will stop the unit completely.
- To restart the operation, push the ON / OFF button on the remote controller.
 - Lightning or a wireless car telephone operating nearby may cause the unit to malfunction. Turn off the main power switch or circuit breaker and then turn them on again. Push the ON / OFF button on the remote controller to restart.

Defrosting operation

If the outdoor unit is frosted during the heating operation, defrosting starts automatically (for approximately 2 to 10 minutes) to maintain the heating capacity.

- The fans in both indoor and outdoor units will stop during the defrosting operation.
- During the defrosting operation, the fan of the indoor unit / outdoor unit stops and the louver of the indoor unit closes.
- During the defrosting operation, the defrosted water will be drained from the bottom plate of the outdoor unit.

Heating capacity

In the heating operation, the heat is absorbed from the outside and brought into the room. This way of heating is called heat pump system. When the outside temperature is too low, it is recommended to use another heating apparatus in combination with the air conditioner.

Air conditioner operating conditions

For proper performance, operate the air conditioner under the following temperature conditions: Refer to the combined outdoor unit installation manual for details about the outdoor temperature.

Cooling operation	Room temperature : 21°C to 32°C (Dry bulb temp.), 15°C to 28°C (Wet bulb temp.)
	[CAUTION] Room relative humidity – less than 80%. If the air conditioner operates in excess of this figure, the surface of the air conditioner may cause dewing.
Heating operation	Room temperature : 15°C to 28°C (Dry bulb temp.)

If air conditioner is used outside of the above conditions, safety protection may work.

Protective device

- Stops operation when the air-conditioner is overloaded.
- If the protective device is activated, the unit stops running, and the operation indicator and check indicator on the remote controller blink.

If the protective device is activated

- Turn off the circuit breaker and perform a checkup. Continued running may cause a malfunction.
- Check whether the air filter is installed. If not, the heat exchanger may be clogged with dust and water leakage may occur.

During cooling

- The air intake or discharge of the outdoor unit is clogged.
- Strong wind continuously blows against the discharge of the outdoor unit.

During heating

- The air filter is clogged with a large amount of dust.
- The air intake or discharge of the indoor unit is clogged.

Do not turn off the circuit breaker

- During the air-conditioning season, leave the circuit breaker turned on, and use the ON / OFF key on the remote controller.

Attention to snowfall and freeze on the outdoor unit

- In snowy areas, the air intake and air discharge of the outdoor unit are often covered with snow or frozen up. If snow or freeze on the outdoor unit is left as it is, it may cause machine failure or poor warming.
- In cold areas, pay attention to the drain hose so that it perfectly drains water without water remaining inside for freeze prevention. If water freezes in the drain hose or inside the outdoor unit, it may cause machine failure or poor warming.

10 Installation

Do not install the air conditioner in the following places

- Do not install the air conditioner in any place within 1 m from a TV, stereo, or radio set. If the unit is installed in such place, noise transmitted from the air conditioner affects the operation of these appliances.
- Do not install the air conditioner near a high frequency appliance (sewing machine or massager for business use, etc.), otherwise the air conditioner may malfunction.
- Do not install the air conditioner in a humid or oily place, or in a place where steam, soot, or corrosive gas is generated.
- Do not install the air conditioner in a salty place such as seaside area.
- Do not install the air conditioner in a place where a great deal of machine oil is used.
- Do not install the air conditioner in a place where it is usually exposed to strong wind such as in seaside area.
- Do not install the air conditioner in a place where sulfurous gas generated such as in a spa.
- Do not install the air conditioner in a vessel or mobile crane.
- Do not install the air conditioner in an acidic or alkaline atmosphere (in a hot-spring area or near a chemicals factory, or in a place subject to combustion emissions). Corrosion may be generated on the aluminum fin and copper pipe of the heat exchanger.
- Do not install the air conditioner near an obstacle (air vent, lighting equipment, etc.) that disturbs discharge air. (Turbulent airflow may reduce the performance or disable devices.)
- Do not use the air conditioner for special purposes such as preserving food, precision instruments, or art objects, or where breeding animals or growing plants are kept.
(This may degrade the quality of preserved materials.)
- Do not install the air conditioner over an object that must not get wet. (Condensation may drop from the indoor unit at a humidity of 80% or more or when the drain port is clogged.)
- Do not install the air conditioner in a place where an organic solvent is used.
- Do not install the air conditioner near a door or window subject to humid outside air.
Condensation may form on the air conditioner.
- Do not install the air conditioner in a place where special spray is used frequently.

Be careful with noise or vibrations

- Do not install the air conditioner in a place where noise by outdoor unit or hot air from its air discharge annoys your neighbors.
- Install the air conditioner on a solid and stable foundation so that it prevents transmission of resonating, operation noise and vibration.
- If one indoor unit is operating, some sound may be audible from other indoor units that are not operating.

11 Specifications

Model	Sound pressure level (dB(A))		Weight (Kg) Main unit (Ceiling panel)
	Cooling	Heating	
RAV-HM301MUT-E	*	*	15 (2.5)
RAV-HM401MUT-E	*	*	15 (2.5)
RAV-HM561MUT-E	*	*	15 (2.5)

* Under 70 dB(A)

Product information of ecodesign requirements. (Regulation (EU) 2016/2281)
<http://ecodesign.toshiba-airconditioning.eu/en>

Declaration of Conformity

Manufacturer: TOSHIBA CARRIER CORPORATION
336 Tadehara, Fuji-shi, Shizuoka-ken 416-8521 JAPAN

TCF holder: TOSHIBA CARRIER EUROPE S.A.S
Route de Thil
01120 Montluel FRANCE

Hereby declares that the machinery described below:

Generic Denomination: Air Conditioner

Model / type: RAV-HM301MUT-E
RAV-HM401MUT-E
RAV-HM561MUT-E

Commercial name: Super Digital Inverter Series Air Conditioner

Complies with the provisions of the "Machinery Directive 2006 / 42 / EC" and the regulations transposing into national law

Name: Sato Kazuhisa
Position: Senior Manager
Quality Assurance & Service Engineering Dept.
Date: 07 April, 2022
Place Issued: Japan

NOTE

This declaration becomes invalid if technical or operational modifications are introduced without the manufacturer's consent.

Declaration of Conformity

Manufacturer: TOSHIBA CARRIER CORPORATION
336 Tadehara, Fuji-shi, Shizuoka-ken 416-8521 JAPAN

TCF holder: TOSHIBA CARRIER UK LTD.
Porsham Close Belliver Industrial Estate Roborough Plymouth Devon
PL6 7DB United Kingdom

Hereby declares that the machinery described below:

Generic Denomination: Air Conditioner

Model / type: RAV-HM301MUT-E
RAV-HM401MUT-E
RAV-HM561MUT-E

Commercial name: Super Digital Inverter Series Air Conditioner

Complies with the provisions of the Supply of Machinery (Safety) Regulations 2008

Name: Sato Kazuhisa
Position: Senior Manager
Quality Assurance & Service Engineering Dept.
Date: 07 April, 2022
Place Issued: Japan

NOTE

This declaration becomes invalid if technical or operational modifications are introduced without the manufacturer's consent.

Toshiba Carrier Corporation

336 TADEHARA, FUJI-SHI, SHIZUOKA-KEN 416-8521 JAPAN

**EH99971001
(DH91308201)**