

**TOSHIBA****INSTALLATION MANUAL  
AND  
OWNER'S MANUAL****R32****INVERTER****AIR CONDITIONER (SPLIT TYPE)****Indoor unit**

**RAS-M05P2KVSG-E**  
**RAS-B07, 10, 13, 16, 18, 22, 24P2KVSG-E**  
**RAS-M05P2KVSGB-E**  
**RAS-B07, 10, 13, 16, 18, 22, 24P2KVSGB-E**

**Outdoor unit**









**RAS-07, 10, 13, 16, 18, 22, 24P2AVSG-E**

Scan QR CODE to access Installation and Owner's Manual on website.

<https://www.toshiba-carrier.co.th/manuals/default.aspx>

Manual are available in BG/CS/DA/DE/EL/EN/ES/ET/FI/FR/HR/HU/IT/LT/LV/LN/NO/PL/PT/RO/RU/SK/SL/SV.

**INSTALLATION MANUAL****ACCESSORIES PARTS**

INDOOR					
No.	Part name	Q'ty	No.	Part name	Q'ty
①	Installation plate 	1	⑥	B Label 	1
②	Wireless remote controller 	1	⑦	Installation and Owner's Manual (This manual) 	1
③	Battery 	2	⑧	Safety Manual 	1
④	Mounting screw 	8	⑨	R32 Information Servicing Manual 	1
⑤	Screw (For 18, 22, 24k model only) 	2			

OUTDOOR		
No.	Part name	Q'ty
⑩	Drain nipple 	1

# INSTALLATION DIAGRAM OF INDOOR AND OUTDOOR UNITS

	05k, 07k, 10k, 13k, 16k	18k, 22k, 24k
A	88	60

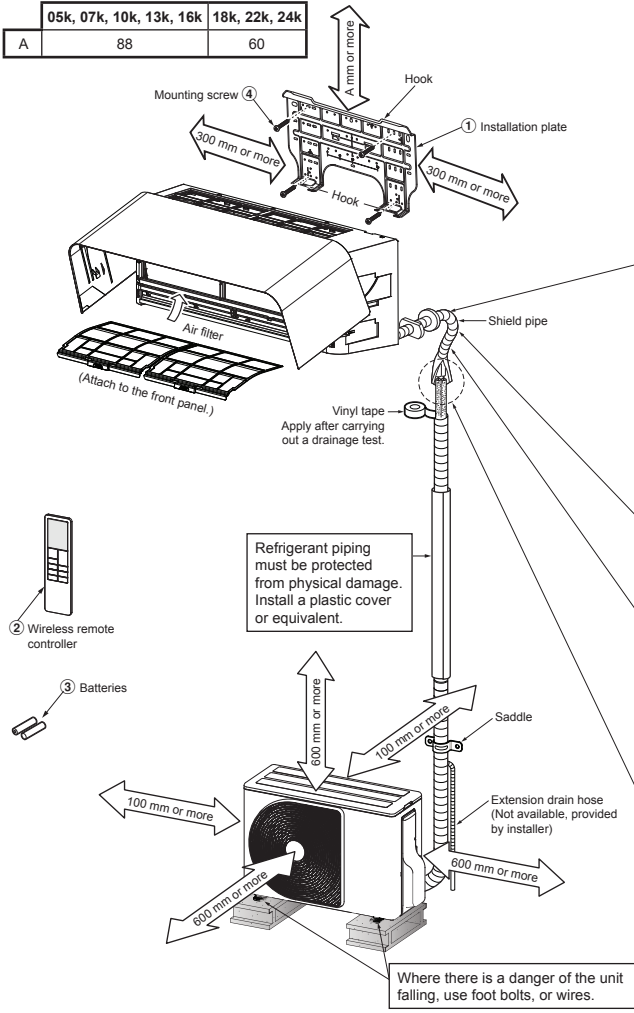

For the rear left, bottom left and left piping

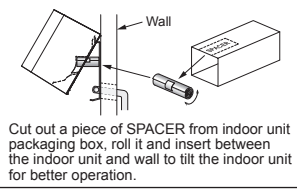

The auxiliary piping can be connected to the left, rear left, rear right, right, bottom right or bottom left.

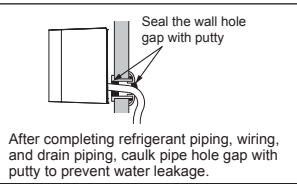
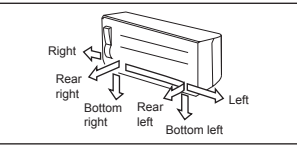

Do not allow the drain hose to get slack

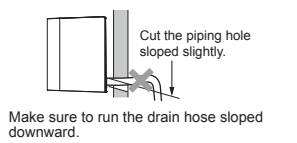

The flare connection should be installed outdoors.

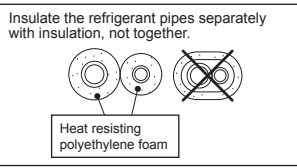

## Optional Installation Parts

Part code	Parts name	Q'ty
A	Refrigerant piping Liquid side : $\varnothing 6.35$ mm Gas side : $\varnothing 9.52$ mm (For 05k, 07k, 10k, 13k) : $\varnothing 12.70$ mm (For 16k, 18k, 22k, 24k)	One each
B	Pipe insulating material (polyethylene foam, 6 mm thick) (For 05k, 07k, 10k, 13k) (polyethylene foam, 8 mm thick) (For 16k, 18k, 22k, 24k)	1
C	Putty, PVC tapes	One each

## Fixing bolt arrangement of outdoor unit

- Secure the outdoor unit with fixing bolts and nuts if the unit is likely to be exposed to a strong wind.
- Use  $\varnothing 8$  mm or  $\varnothing 10$  mm anchor bolts and nuts.
- If it is necessary to drain the defrost water, attach drain nipple ⑩ to the bottom plate of the outdoor unit before installing it.

For 07k, 10k, 13k, 16k, 18k, 22k For 24k

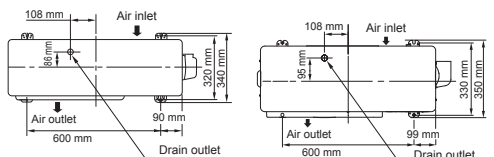

※ When using a multi-system outdoor unit, refer to the Installation Manual provided with the model concerned.

# INDOOR UNIT

## Installation Place

- A place which provides the spaces around the indoor unit as shown in the diagram.
  - A place where there are no obstacles near the air inlet and outlet.
  - A place which allows easy installation of the piping to the outdoor unit.
  - A place which allows the front panel to be opened.
  - The indoor unit shall be installed at least 2.5 m height.
- Also, it must be avoided to put anything on the top of the indoor unit.

### CAUTION

- Direct sunlight to the indoor unit's wireless receiver should be avoided.
- The microprocessor in the indoor unit should not be too close to RF noise sources.

## Remote controller

- A place where there are no obstacles such as a curtain that may block the signal from the indoor unit.
- Do not install the remote controller in a place exposed to direct sunlight or close to a heating source such as a stove.
- Keep the remote controller at least 1 m apart from the nearest TV set or stereo equipment. (This is necessary to prevent image disturbances or noise interference.)
- The location of the remote controller should be determined as shown below.

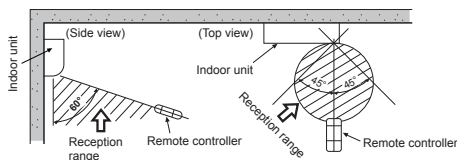

## Cutting a Hole and Mounting Installation Plate

### Cutting a hole

When installing the refrigerant pipes from the rear.

For 05k, 07k, 10k, 13k, 16k

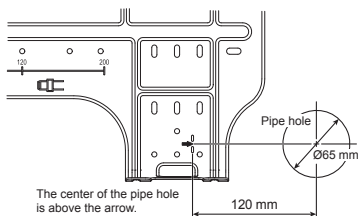

For 18k, 22k, 24k

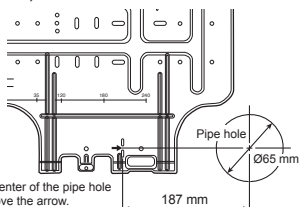

1. After determining the pipe hole position on the mounting plate (➡), drill the pipe hole (Ø65 mm) at a slight downward slant to the outdoor side.

### NOTE

- When drilling a wall that contains a metal lath, wire lath or metal plate, be sure to use a pipe hole brim ring sold separately.

## Mounting the installation plate

For 05k, 07k, 10k, 13k, 16k

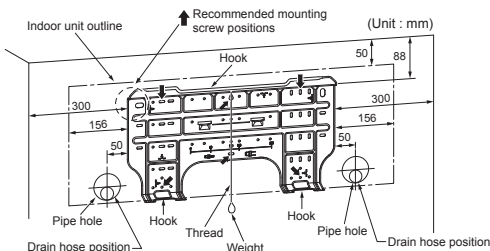

For 18k, 22k, 24k

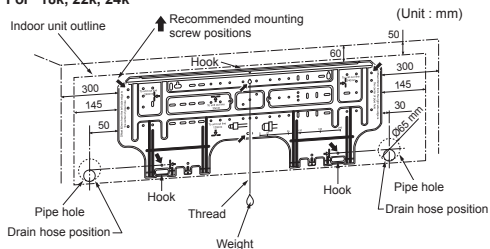

## Directly mounting indoor unit to the wall preparation

- In the case of block, brick, concrete or similar type wall, determining the mount screw position on the wall can be used position as below for drill hole to insert clip anchors for appropriate mounting screw.

For 05k, 07k, 10k, 16k

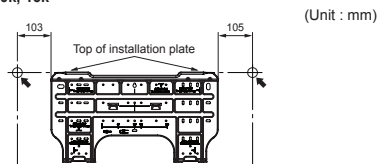

For 18k, 22k, 24k

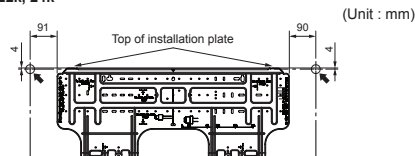

- The provided screws should be used to fix the indoor unit directly to the wall at the predetermined position.

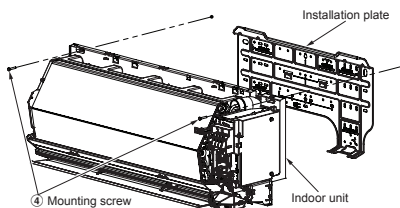

## Space allows under indoor unit

- Space allows for moving range of the air inlet grille and horizontal louver in operation above curtain rails, window cornice or other objects.

(Unit : mm)

	A	B	C	D	E	F
05k, 07k, 10k, 13k, 16k	463	50	293	60	140	55
18k, 22k, 24k	492	50	320	70	170	67

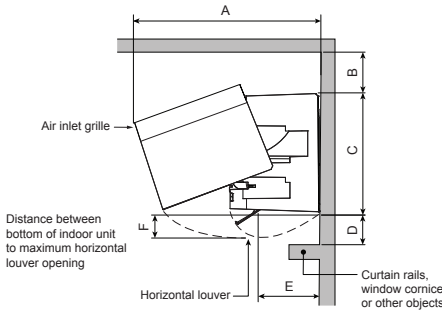

### CAUTION

- If have curtain rails, window cornice or other objects, allow space from the indoor unit as below.
  - For model 05k, 07k, 10k, 13k, 16k should be 60 mm or more.
  - For model 18k, 22k, 24k should be 70 mm or more.
- If allow space is less than stated above, this can affect the opening and closing of the air inlet grille and the horizontal louver.
- However, there should be no objects in the air outlet position.
- It will block the air flow direction and drop performance.

## When the installation plate is directly mounted on the wall

- Securely fit the installation plate onto the wall by screwing it in the upper and lower parts to hook up the indoor unit.
- To mount the installation plate on a concrete wall with anchor bolts, use the anchor bolt holes as illustrated in the below figure.
- Install the installation plate horizontally in the wall.

### CAUTION

- When installing the installation plate with a mounting screw, do not use the anchor bolt holes. Otherwise, the unit may fall down and result in personal injury and property damage.

Installation plate  
(Keep horizontal direction.)

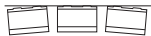

5 mm dia. hole



Mounting screw  
Ø4 mm × 25 ℓ



Clip anchor  
(local parts)

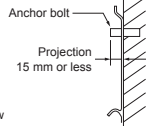

### CAUTION

- Failure to firmly install the unit may result in personal injury and property damage if the unit falls.
- In case of block, brick, concrete or similar type walls, make 5 mm dia. holes in the wall.
- Insert clip anchors for appropriate ④ mounting screws.

### NOTE

- Secure four corners and lower parts of the installation plate with 4 to 6 mounting screw to install it.

## Piping and Drain Hose Installation

### Piping and drain hose forming

- Since dewing results in a machine trouble, make sure to insulate both connecting pipes. (Use polyethylene foam as insulating material.)
- The connection of pipes can be installed in the following directions.

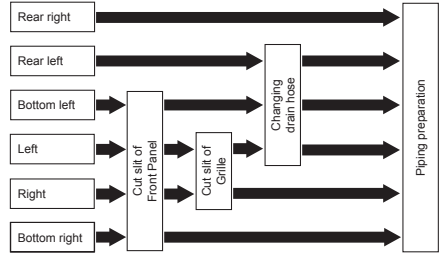

#### Rear right

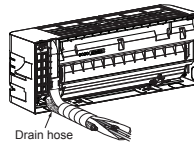

#### Rear left

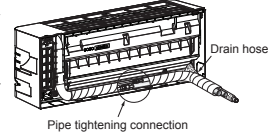

#### Bottom right

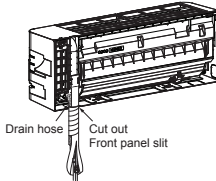

#### Bottom left

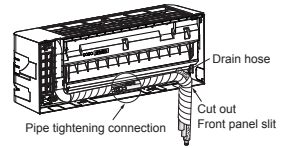

#### Right

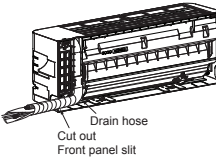

#### Left

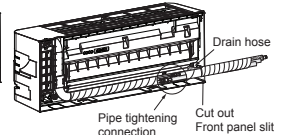

#### 1. Cut Front panel slit

- Cut out the slit on the bottom left or bottom right side of the Front panel for the bottom left or bottom right connection with a coping saw.

#### 2. Cut Grille slit

- Cut out the slit on the left or right side of the Air inlet grille for the left or right connection with a coping saw.

#### 3. Changing drain hose

- The factory default of the drain hose is installed on the right side.
- For left, bottom leftward or rear leftward connection's piping, it is necessary to change the drain hose and drain cap.

### How to cutting the Front panel

- To connect piping to the left, right or bottom side, the Front panel must be cut off.
- The marking for cutting are indicated on the Front panel in the following positions.

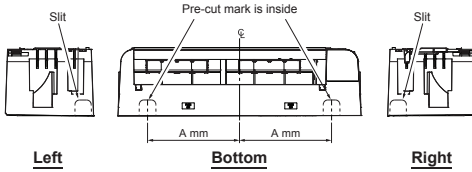

Model	A
05k, 07k, 10k, 13k, 16k	305
18k, 22k, 24k	439

- Cut off the pipe exist from inside of Front panel using a coping saw or an equivalent tool.
- The plastic burrs from the cutting process should be removed with a half round file or an equivalent tool.

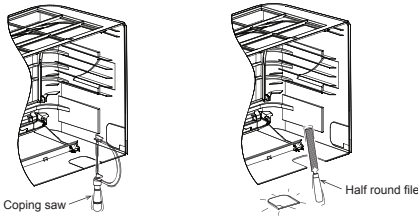

### How to cutting the air inlet grille

- To connect piping to the left or right side, the air inlet grille must be cut off.
- The marking for cutting are indicated on the inside of the air inlet grille in the following positions.

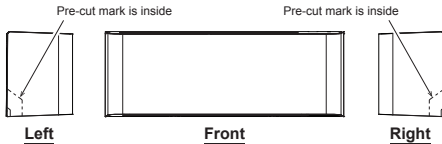

- Cut off the pipe exist from inside of the Air inlet grille using a coping saw or an equivalent tool.
- The plastic burrs from the cutting process should be removed with a half round file or an equivalent tool.

### CAUTION

When cutting the Front panel and the Air inlet grille, be careful of cutting tools and any sharp edges of plastic. It can cause injuries.

### How to remove the drain hose

- The drain hose can be removed by removing the screw securing the drain hose and then pulling out the drain hose.
- When removing the drain hose, be careful of any sharp edges of steel plate. The edges can injure.
- To install the drain hose, insert the drain hose firmly until the connection part contacts with heat insulator, and then secure it with original screw.

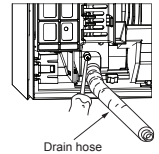

### How to remove the drain cap

Clip the drain cap by needle-nose pliers and pull out.

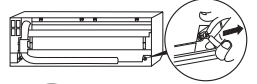

### How to fix the drain cap

- Insert hexagon wrench (4 mm) in a center head.
- Firmly insert the drain cap.

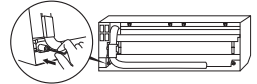

Do not apply lubricating oil (refrigerant machine oil) when inserting the drain cap. Application causes deterioration and drain leakage of the plug.

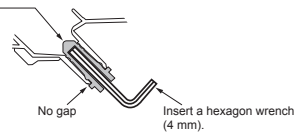

### CAUTION

- Firmly insert the drain hose and drain cap; otherwise, water may leak.

### Left-hand connection with piping

- Bend the connecting pipe so that it is laid within 43 mm above the wall surface. If the connecting pipe is laid exceeding 43 mm above the wall surface, the indoor unit may unstably be set on the wall.
- When bending the connecting pipe, make sure to use a spring bender so as not to crush the pipe.

### Bend the connecting pipe within a radius of 30 mm.

To connect the pipe after installation of the unit (figure)

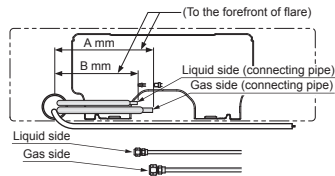

Model	A	B
05k, 07k, 10k, 13k, 16k	260	210
18k, 22k, 24k	480	380

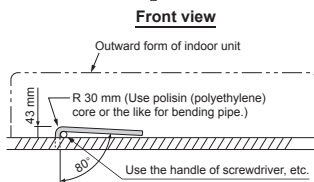

### Bottom view

### NOTE

- If the pipe is bent incorrectly, the indoor unit may unstably be set on the wall. After passing the connecting pipe through the pipe hole, connect the connecting pipes to the auxiliary pipes and wrap the facing tape around them.

## CAUTION

- Bind the auxiliary pipes (two) and connecting cable with facing tape tightly. In case of leftward piping and rear-leftward piping, bind the auxiliary pipes (two) only with facing tape.

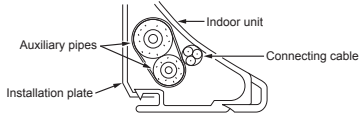

- Carefully arrange pipes so that any pipe does not stick out of the rear plate of the indoor unit.
- Carefully connect the auxiliary pipes and connecting pipes to one another and cut off the insulating tape wound on the connecting pipe to avoid double-taping at the joint; moreover, seal the joint with the vinyl tape, etc.
- Since dewing results in a machine trouble, make sure to insulate both connecting pipes. (Use polyethylene foam as insulating material.)
- When bending a pipe, carefully do it, not to crush it.

## Indoor Unit Fixing

- Pass the pipe through the hole in the wall and hook the indoor unit on the installation plate at the upper hook.
- Swing the indoor unit to right and left to confirm that it is firmly hooked up on the installation plate.
- While pressing the indoor unit onto the wall, hook it at the lower part on the installation plate. Pull the indoor unit toward you to confirm that it is firmly hooked up on the installation plate.

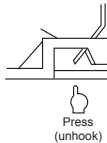
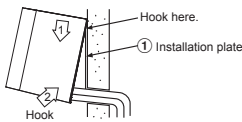

- For detaching the indoor unit from the installation plate, pull the indoor unit toward you while pushing its bottom up at the specified parts.

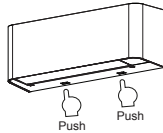

## INFORMATION

- The lower part of indoor unit may float, due to the condition of piping and you cannot fix it to the installation plate. In that case, use the ⑤ screws provided to fix the unit and the installation plate. (For 18, 22, 24k model only)

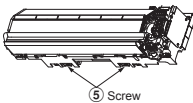

## Drainage

- Run the drain hose sloped downwards.

### NOTE

- The hole should be made at a slight downward slant on the outdoor side.

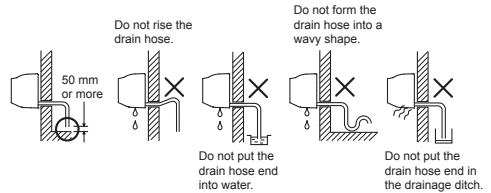

- Put water in the drain pan and make sure that the water is drained out of door.
- When connecting extension drain hose, insulate the connecting part of extension drain hose with shield pipe.

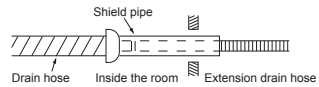

## CAUTION

- Arrange the drain pipe for proper drainage from the unit.
- Improper drainage can result in dew-dropping.
- This air conditioner has the structure designed to drain water collected from dew, which forms on the back of the indoor unit, to the drain pan.
- Therefore, do not store the power cord and other parts at a height above the drain guide.

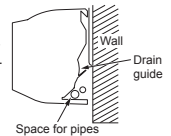

# OUTDOOR UNIT

## Installation Place

- A place which provides the spaces around the outdoor unit as shown in the diagram.
- A place which can bear the weight of the outdoor unit and does not allow an increase in noise level and vibration.
- A place where the operation noise and discharged air do not disturb your neighbors.
- A place which is not exposed to a strong wind.
- A place free of a leakage of combustible gases.
- A place which does not block a passage.
- When the outdoor unit is to be installed in an elevated position, be sure to secure its feet.
- The allowable length of the connecting pipe.

Model	07k	10k	13k	16k	18k	22k	24k
Chargeless	Up to 15 m	Up to 15 m	Up to 15 m	Up to 15 m	Up to 15 m	Up to 15 m	Up to 15 m
Maximum length	20 m	20 m	20 m	20 m	20 m	20 m	25 m
Additional refrigerant charging	16 - 20 m (20 g / 1 m)						16 - 25 m (20 g / 1 m)
Maximum refrigerant charging	0.65 kg	0.75 kg	0.90 kg	0.90 kg	1.20 kg	1.20 kg	1.34 kg

- The allowable height of outdoor unit installation site.

Model	07k	10k	13k	16k	18k	22k	24k
Maximum height	12 m						15 m

- A place where the drain water does not raise any problems or with good drainage.
- A place where it can be installed horizontally.

## Precautions for adding refrigerant

- Use a scale having a precision with at least 10 g per index line when adding the refrigerant.
- Do not use a bathroom scale or similar instrument.

## CAUTION

- When the outdoor unit is installed in a place where the drain water might cause any problems, Seal the water leakage point tightly using a silicone adhesive or caulking compound.

## Precautions about Installation in Regions with Snowfall and Cold Temperatures

- Drain the water from all the drain holes directly.
- To protect the outdoor unit from snow accumulation, install a holding frame, and attach a snow protection hood and plate.
  - \* Do not use a double-stacked design.

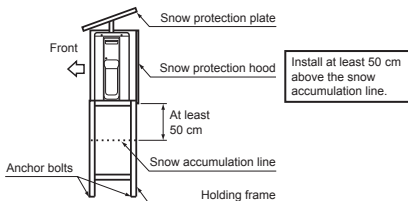

## CAUTION

1. Install the outdoor unit without anything blocking the air discharging.
2. When the outdoor unit is installed in a place always exposed to strong wind like a coast or on a high storey of a building, secure the normal fan operation using a duct or a windshield.
3. In particularly windy areas, install the unit such as to avoid admission of wind.
4. Installation in the following places may result in trouble. Do not install the unit in such places.
  - A place full of machine oil.
  - A saline-place such as the coast.
  - A place full of sulfide gas.
  - A place where high-frequency waves are likely to be generated as from audio equipment, welders, and medical equipment.

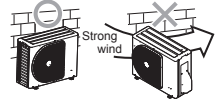

## Draining the Water

- Holes are provided on the base plate of the outdoor unit to ensure that the defrost water produced during heating operations is drained off efficiently.
- If a centralized drain is required when installing the unit on a balcony or wall, follow the steps below to drain off the water.

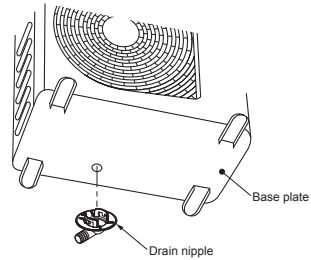

- Install the drain nipple and a commercially available drain hose (with 16 mm inside diameter), and drain off the water. (For the position where the drain nipple is installed, refer to the installation diagram of the indoor and outdoor units.)
  - Check that the outdoor unit is horizontal, and route the drain hose at a downward sloped angle while ensuring that it is connected tautely.

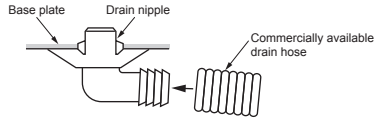

## CAUTION

- Do not use ordinary garden hose, but one can flatten and prevent water from draining.

## Refrigerant Piping Connection

### Flaring

- Cut the pipe with a pipe cutter.



- Insert a flare nut into the pipe and flare the pipe.

- Projection margin in flaring : A (Unit : mm)

RIDGID (clutch type)

Outer dia. of copper pipe	Tool used	Conventional tool used
Ø6.35	0 to 0.5	1.0 to 1.5
Ø9.52	0 to 0.5	1.0 to 1.5
Ø12.70	0 to 0.5	1.0 to 1.5
Pipes thickness	0.8 mm or more	

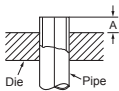

IMPERIAL (wing nut type)

Outer dia. of copper pipe	Tool used
Ø6.35	1.5 to 0.5
Ø9.52	1.5 to 0.5
Ø12.70	2.0 to 0.5
Pipes thickness	0.8 mm or more

### CAUTION

- Do not scratch the inner surface of the flared part when removing burrs.
- Flare processing under the condition of scratches on the inner surface of flare processing part will cause refrigerant gas leak.

### Tightening connection

Align the centers of the connecting pipes and tighten the flare nut as far as possible with your fingers. Then tighten the nut with a spanner and torque wrench as shown in the figure.

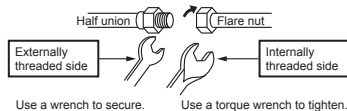

### CAUTION

- Do not apply excess torque. Otherwise, the nut may crack depending on the conditions.

Outer dia. of copper pipe	Tightening torque (N·m)
Ø6.35 mm	14 to 18 (1.4 to 1.8 kgf·m)
Ø9.52 mm	30 to 42 (3.0 to 4.2 kgf·m)
Ø12.70 mm	50 to 62 (5.0 to 6.2 kgf·m)

### Tightening torque of flare pipe connections

The operating pressure of R32 is higher than that of R22 (approx. 1.6 times). It is therefore necessary to firmly tighten the flare pipe connecting sections (which connect the indoor and outdoor units) up to the specified tightening torque. Incorrect connections may cause not only a gas leakage, but also damage to the refrigeration cycle.

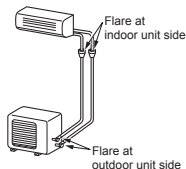

## Evacuating

After the piping has been connected to the indoor unit, you can perform the air purge together at once.

### AIR PURGE

Evacuate the air in the connecting pipes and in the indoor unit using a vacuum pump.

Do not use the refrigerant in the outdoor unit.  
For details, see the manual of the vacuum pump.

### Using a vacuum pump

Be sure to use a vacuum pump with counter-flow prevention function so that inside oil of the pump does not flow backward into pipes of the air conditioner when the pump stops. (If oil inside of the vacuum pump enters the air conditioner, which use R32, refrigeration cycle trouble may result.)

- Connect the charge hose from the manifold valve to the service port of the packed valve at gas side.
- Connect the charge hose to the port of the vacuum pump.
- Open fully the low pressure side handle of the gauge manifold valve.
- Operate the vacuum pump to start evacuating. Perform evacuating for about 15 minutes if the piping length is 20 meters. (15 minutes for 20 meters) (assuming a pump capacity of 27 liters per minute) Then confirm that the compound pressure gauge reading is  $-101$  kPa ( $-76$  cmHg).
- Close the low pressure side valve handle of the gauge manifold valve.
- Open fully the valve stem of the packed valves (both gas and liquid sides).
- Remove the charging hose from the service port.
- Securely tighten the caps on the packed valves.

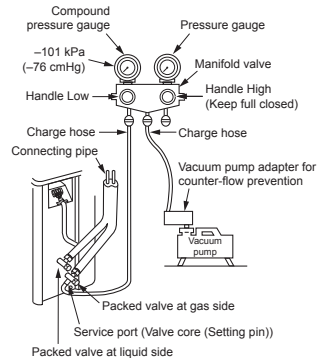

### CAUTION

#### KEEP IMPORTANT 7 POINTS FOR PIPING WORK.

- Take away dust and moisture (inside of the connecting pipes).
- Tighten the connections (between pipes and unit).
- Evacuate the air in the connecting pipes using a VACUUM PUMP.
- Check gas leak (connected points).
- Be sure to fully open the packed valves before operation.
- Reusable mechanical connectors and flared joints are not allowed indoors.  
When mechanical connectors are reused indoors, sealing parts shall be renewed.  
When flared joints are reused indoors, the flare part shall be refabricated.
- Don't operate air conditioner in case no refrigerant in the system.

## Packed valve handling precautions

- Open the valve stem all the way out, but do not try to open it beyond the stopper.

Pipe size of Packed Valve	Size of Hexagon wrench
12.70 mm and smaller	A = 4 mm
15.88 mm	A = 5 mm

## Pump down process

1. Turn off the Air Conditioner system.
2. Connect the charge hose from the manifold valve to the service port of the packed valve at gas side.
3. Turn on the Air Conditioner system in cooling operation more than 10 minutes.
4. Check the operating pressure of the system should be normal value. (Ref. with product specification)
5. Release the valve rod cap of both service valves.
6. Use the Hexagon wrench to turning the valve rod of Liquid side fully close. (\*Make sure no entering air into the system)
7. Continue operate Air Conditioner system until the gauge of manifold dropped into the range of 0.5 - 0 kgf/cm<sup>2</sup>.
8. Use the Hexagon wrench to turning the valve rod of Gas side fully close. And turn off the Air Conditioner system immediately thereafter.
9. Remove the gauge manifold from the service port of the packed valve.
10. Securely tighten the valve rod cap to the both service valves.

### CAUTION

- Should be check the compressor operating condition while pumping down process. It must not any abnormal sound, more vibration. If is abnormal condition appears and must turn off the air conditioner immediately.
- Securely tighten the valve cap with torque in the following table:

Cap	Cap Size (H)	Torque
Valve Rod Cap	H17 - H19	14~18 N·m (1.4 to 1.8 kgf·m)
	H22 - H30	33~42 N·m (3.3 to 4.2 kgf·m)
Service Port Cap	H14	8~12 N·m (0.8 to 1.2 kgf·m)
	H17	14~18 N·m (1.4 to 1.8 kgf·m)

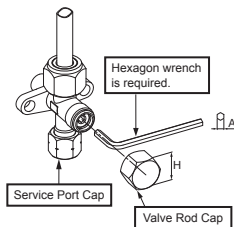

# ELECTRICAL WORKS

Model	07k	10k	13k	16k	18k	22k	24k
Power source	50Hz, 220 – 240V Single phase						
Maximum running current	4.5A	6.2A	8.0A	9.5A	10.0A	12.0A	12.0A
Circuit breaker rating	10A	10A	10A	16A	16A	16A	16A
Power supply cable	H07RN-F or 60245 IEC66 (1.0 mm <sup>2</sup> or more)			H07RN-F or 60245 IEC66 (1.5 mm <sup>2</sup> or more)			
Connecting cable	H07RN-F or 60245 IEC66 (1.0 mm <sup>2</sup> or more)			H07RN-F or 60245 IEC66 (1.5 mm <sup>2</sup> or more)			

## Indoor unit

Wiring of the connecting cable can be carried out without removing the front panel.

- Remove the air inlet grille.  
Open the air inlet grille upward and pull it toward you.
- Remove the terminal cover and cord clamp.
- Insert the connecting cable (according to the local cords) into the pipe hole on the wall.
- Take out the connecting cable through the cable slot on the rear panel so that it protrudes about 20 cm from the front.
- Insert the connecting cable fully into the terminal block and secure it tightly with screws.
- Tightening torque : 1.2 N·m (0.12 kgf·m)
- Secure the connecting cable with the cord clamp.
- Fix the terminal cover, rear plate bushing and air inlet grille on the indoor unit.

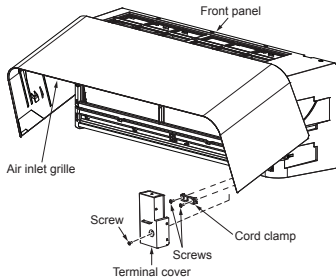

## How to install the air inlet grille

- Fit the left and right arms of the air inlet grille to the slot holes on the two sides of the front panel and push in completely.

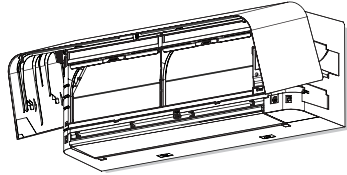

- Close the air inlet grille.

Be sure to press the positions as indicated by the arrow in order to attach the air inlet grille to the indoor unit.

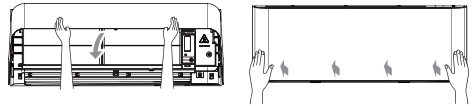

## CAUTION

- The air inlet grille should be removed before installing the indoor unit. To avoid damage to the corner of the air inlet grille or the wall.

## How to remove the air inlet grille

- Be careful open the air inlet grille until arm touch the stopper of the front panel.
- Push arms on left and right side to outward direction then pull toward you to remove front panel.

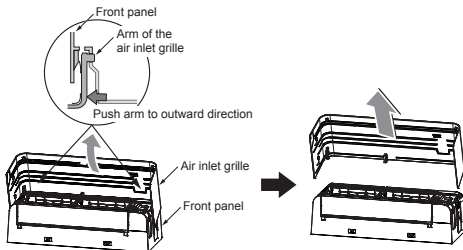

## Outdoor unit

- Remove the valve cover, the electric parts cover and the cord clamp from the outdoor unit.
- Connect the connecting cable to the terminal as identified by the matching numbers on the terminal block of indoor and outdoor unit.
- Insert the power cord and the connecting cable carefully into the terminal block and secure it tightly with screws.
- Use vinyl tape, etc. to insulate the cords which are not going to be used. Locate them so that they do not touch any electrical or metal parts.
- Secure the power cord and the connecting cable with the cord clamp.
- Attach the electric parts cover and the valve cover on the outdoor unit.

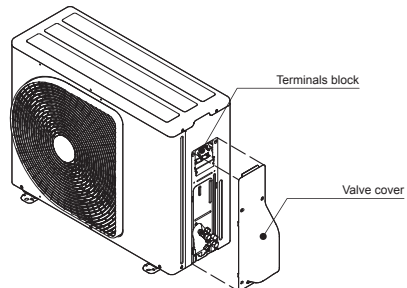

## OTHERS

### Gas Leak Test

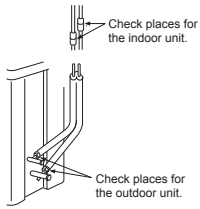

- Check the flare nut connections for the gas leak with a gas leak detector or soap water.

### Test Operation

To switch the TEST RUN (COOL) mode, press [RESET] button for 10 seconds. (The beeper will make a short beep.)

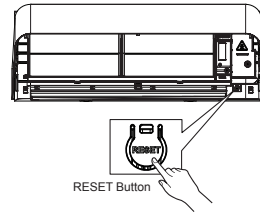

# In Case of Indoor Unit Connect With 1:1 Outdoor Unit

## Power Supply Input at Outdoor Unit Terminal Block (Recommend)

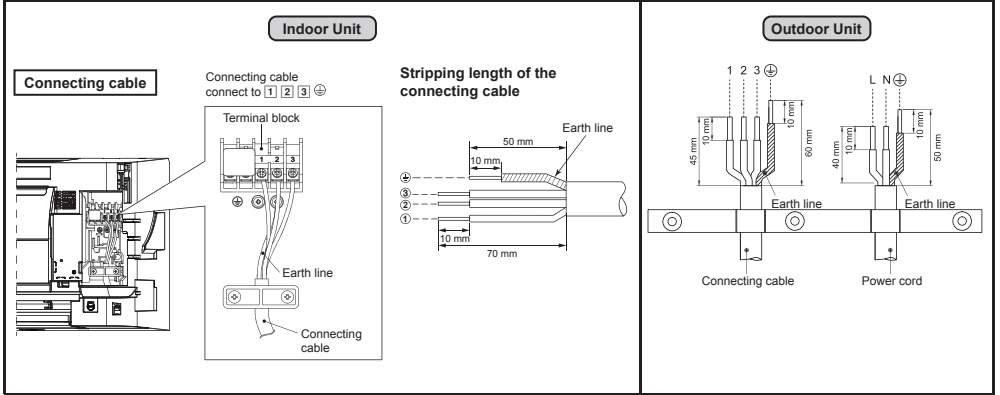

## Power Supply Input at Indoor Unit Terminal Block (Optional)

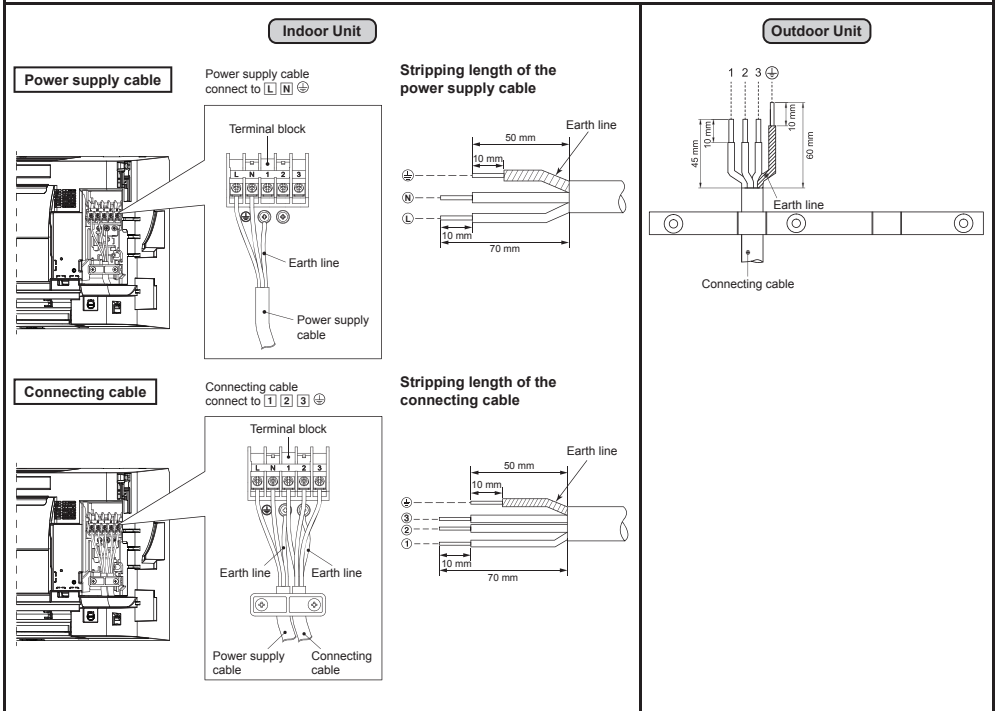

## Power supply input Wiring Diagram for 1:1 Outdoor Unit

### Power supply input at Outdoor Terminal Block (Recommend)

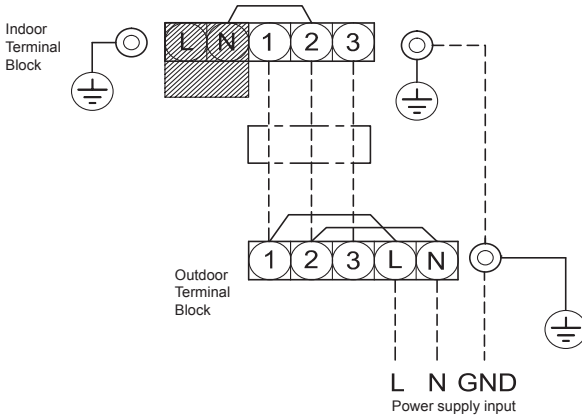

### Power supply input at Indoor Terminal Block (Optional)

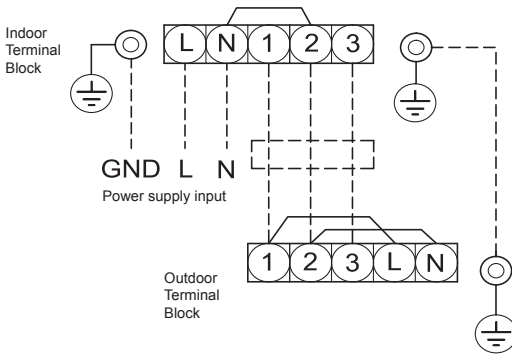

### ⚠ CAUTION

1. The power supply must be same as the rated of air conditioner.
2. Prepare the power source for exclusive use with air conditioner.
3. Circuit breaker must be used for the power supply line of this air conditioner.
4. Be sure to comply power supply and connecting cable for size and wiring method.
5. Every wire must be connected firmly.
6. Perform wiring works so as to allow a general wiring capacity.
7. Wrong wiring connection may cause some electrical part burn out.
8. Incorrect or incomplete wiring is carried out, it will cause an ignition or smoke.
9. This product can be connected to main power supply.

Connection to fixed wiring : A switch which disconnects all poles and has a contact separation at least 3 mm must be incorporated in the fixed wiring.

## In Case of Indoor Unit Connect With Inverter Multi System (IMS)

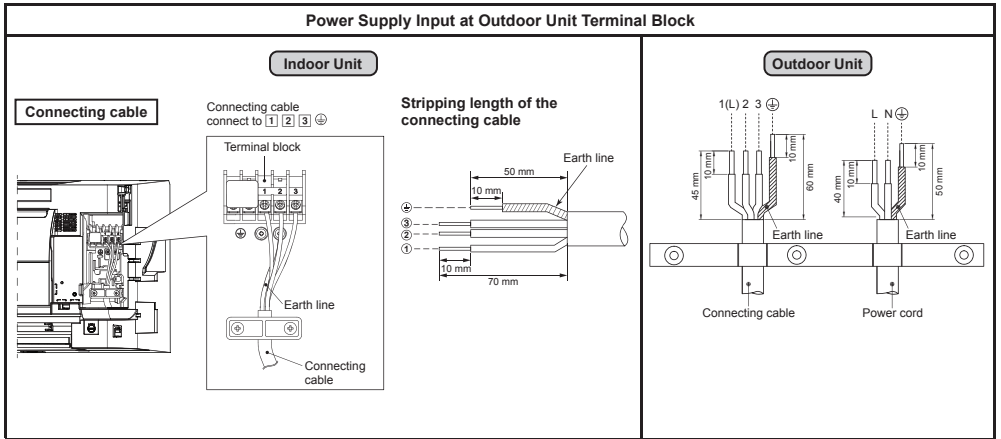

### Power supply input Wiring Diagram for Inverter Multi System (IMS)

#### Power supply input at Outdoor Terminal Block

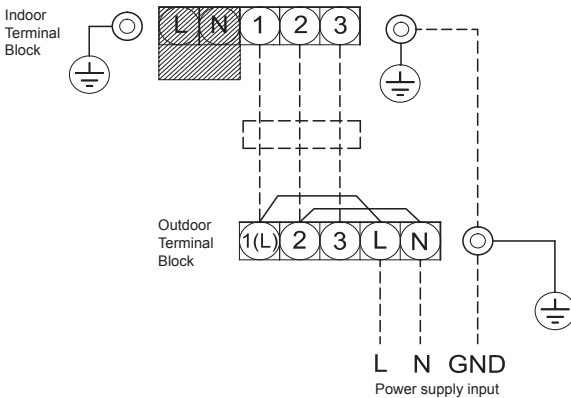

#### **CAUTION**

1. The power supply must be same as the rated of air conditioner.
2. Prepare the power source for exclusive use with air conditioner.
3. Circuit breaker must be used for the power supply line of this air conditioner.
4. Be sure to comply power supply and connecting cable for size and wiring method.
5. Every wire must be connected firmly.
6. Perform wiring works so as to allow a general wiring capacity.
7. Wrong wiring connection may cause some electrical part burn out.
8. Incorrect or incomplete wiring is carried out, it will cause an ignition or smoke.
9. This product can be connected to main power supply.  
 Connection to fixed wiring : A switch which disconnects all poles and has a contact separation at least 3 mm must be incorporated in the fixed wiring.

## Existing Piping

### Work instructions

The existing R22 and R410A piping can be reused for inverter R32 product installations.



- Confirming the existence of scratches or dents on the existing pipes and confirming the reliability of the pipe strength are conventionally referred to the local site.
- the specified conditions are not cleared, it is possible to reuse existing R22 and R410A pipes to those for R32 models.

### Basic conditions needed to reuse the existing pipe

Check and observe the presence of three conditions in the refrigerant piping works.

- Dry** (There is no moisture inside of the pipes.)
- Clean** (There is no dust inside of the pipes.)
- Tight** (There are no refrigerant leaks.)

### Restrictions for use of existing pipes

In the following cases, the existing pipes should not be exchanged as they are. Clean the existing pipes or exchange them with new pipes.

- When a scratch or dent is heavy, be sure to use new pipes for the refrigerant piping works.
- When the existing pipe thickness is thinner than the specified "Pipe diameter and thickness," be sure to use new pipes for the refrigerant piping works.

The operating pressure of R32 is high (1.6 times that of R22). If there is a scratch or dent on the pipe or a thinner pipe is used, the pressure strength may be inadequate, which may cause the pipe to break in the worst case.

#### Pipe diameter and thickness (mm)

Pipe outer diameter	Ø6.4	Ø9.5	Ø12.7
Thickness	R32, R410A	0.8	0.8
	R22		

- When the outdoor unit was left with the pipes disconnected or the gas leaked from the pipes and the pipes were not repaired and refilled.

There is the possibility of rain water or air, including moisture, entering the pipe.

- When refrigerant cannot be recovered using a refrigerant recovery unit.

There is the possibility that a large quantity of dirty oil or moisture remains inside the pipes.

- When a commercially available dryer is attached to the existing pipes.

- There is the possibility that copper green rust has been generated.

- When the existing air conditioner is removed after Check if the oil has been recovered.
  - Check if the oil is judged to be clearly different from normal oil.

- The refrigerant oil is copper rust green in color. There is the possibility that moisture has mixed with the oil and rust has been generated inside the pipe.
- There is discolored oil, a large quantity of residue, or a bad smell.
- A large quantity of shiny metal dust or other wear residue can be seen in the refrigerant oil.

- When the air conditioner has a history of the compressor failing and being replaced.
  - When discolored oil, a large quantity of residue, shiny metal dust, or other wear residue or mixture of foreign matter is observed, trouble will occur.

- When temporary installation and removal of the air conditioner are repeated such as when leased etc.

- If the type of refrigerant oil of the existing air conditioner is other than the following oil (Mineral oil), Suniso, Freol-S, MS (Synthetic oil), alkyl benzene (HAB, Barrel-freeze), ester series, PVE only of other series.
  - The winding-insulation of the compressor may deteriorate.

### NOTE

The above descriptions are results have been confirmed by our company and represent our views on our air conditioners, but do not guarantee the use of the existing pipes of air conditioners that have adopted R32 in other companies.

### Curing of pipes

When removing and opening the indoor or outdoor unit for a long time, cure the pipes as follows:

- Otherwise rust may be generated when moisture or foreign matter due to condensation enters the pipes.
- The rust cannot be removed by cleaning, and new pipes are necessary.

Placement location	Term	Curing manner
Outdoors	1 month or more Less than 1 month	Pinching
Indoors	Every time	Pinching or taping

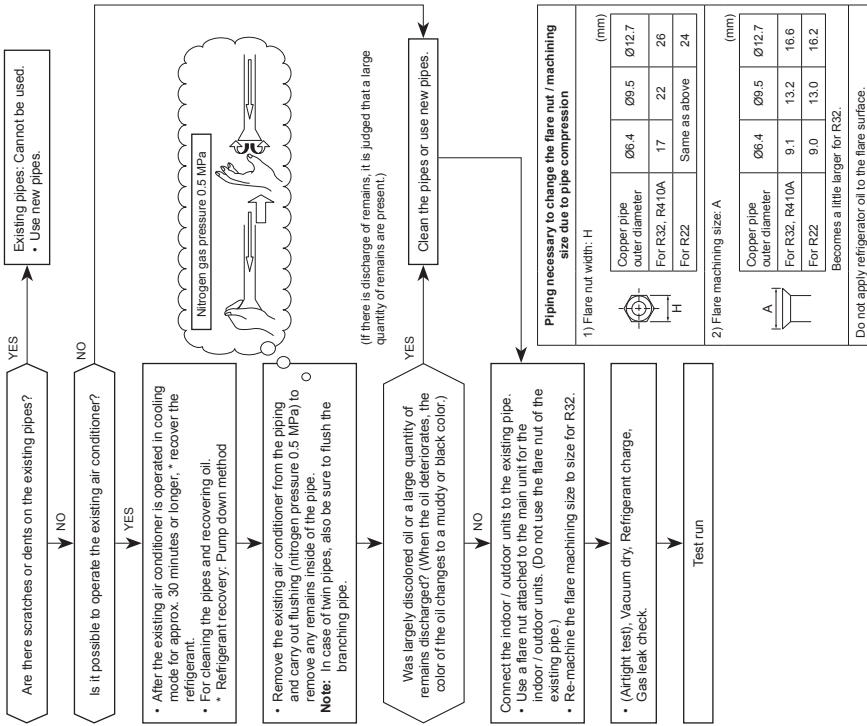

**Piping necessary to change the flare nut / machining size due to pipe compression**

1) Flare nut width: H	(mm)
Copper pipe outer diameter	Ø6.4
For R32, R410A	Ø9.5
For R22	Ø12.7
Same as above	17
	22
	26
	24

2) Flare machining size: A

(mm)	
Copper pipe outer diameter	Ø6.4
For R32, R410A	Ø9.5
For R22	Ø12.7
Same as above	9.1
	13.2
	16.6
	13.0
	16.2

Becomes a little larger for R32.

Do not apply refrigerant oil to the flare surface.

# INSTALLATION CHECK LIST

After finishing installation work, please check items below and hand this sheet to user to keep it in a safe place together with Installation and Owner's Manual

Model name \_\_\_\_\_

Check date \_\_\_\_\_

Checked by \_\_\_\_\_

**Note :** Please put a mark “ ✓ ” in the box you checked.

## ■ Piping work

Check items	Symptom	Check
Connecting pipes are cleaned and no dent	Insufficient Air conditioner capacity Compressor malfunction Compressor rupture or Burst	
Use vacuum pump for completed vacuuming		
No any gas leakage or clogging is found		
Service valves are fully open before operation		

## ■ Wiring work

Check items	Symptom	Check
Electrical wires are connected correctly	Burnt out, No operation	
Use breaker to connect to main power supply	Burnt out, No abnormal protection	
Wiring insulators are in good condition	Burnt out, Electrical leakage	
Use the specified size/rating wires	Burnt out	
Ground wire must be Installation per manufacturing Installation and Owner's Manual	Electrical leakage or shock	

## ■ Drainage work

Check items	Symptom	Check
Drain hose is properly connected	Water leakage or dropping	
Drain hose is well insulated	Water or dew dropping	

### Remark

- All check items, please refer procedure from manufacturing Installation and Owner's Manual.

# OWNER'S MANUAL

## 1 INDOOR UNIT DISPLAY

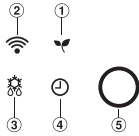

- ① ECO (White)
- ② Wi-Fi access (White)
- ③ Strong defrost (White)
- ④ Timer (White)
- ⑤ Operation mode
  - Cool (Blue)
  - Heat (Orange)

• Display brightness can be adjusted, follow procedure on ⑪.

## 2 PREPARATION BEFORE USE

### Preparing Filters

- Open the air inlet grille and remove the air filters.
- Attach the filters. (see detail in the Installation Manual).

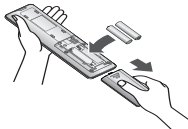

### Loading Batteries (when use wireless operation.)

- Remove the slide cover.
- Insert 2 new batteries (AAA type) following the (+) and (-) positions.

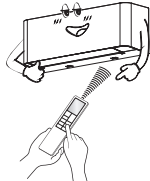

### Remote Controller Reset

- Remove the batteries.
- Press .
- Insert the batteries.

## 3 AIR FLOW DIRECTION

<b>1</b>	Press : Move the louver in the desired vertical direction.	
<b>2</b>	Press : Move the louver in the desired horizontal direction.	
<b>3</b>	Press : For select louver setting operation.	<ul style="list-style-type: none"> <li>• Vertical (Up-Down) swing</li> <li>• Horizontal (Left-Right) swing</li> <li>• Vertical and Horizontal Swing</li> <li>• HADA Care flow</li> </ul> <p>Air flow upward to the ceiling, provide indirect air flow to body and homogenize room temperature.</p>

### NOTE

- During HADA Care Flow mode, FIX button cannot active.
- Do not move the louver manually by hands or others.
- The louver may automation positioning by some operation mode.

## 4 REMOTE CONTROLLER

- ① Infrared signal emitter
- ② Start/Stop button
- ③ Mode select button
- ④ Temperature button
- ⑤ Fan speed button
- ⑥ Menu select button
- ⑦ Swing louver button
- ⑧ Exit button
- ⑨ Set louver Up-Down button
- ⑩ Set louver Left-Right button
- ⑪ Check button\*

\* Check button under battery cover

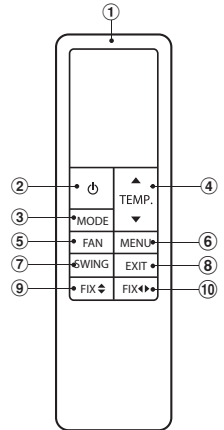
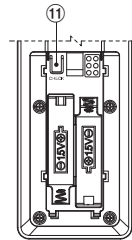

## 5 COOLING / FAN ONLY OPERATION

- Press : Select Cool or Fan only .
- Press : Set the desired temperature.  
Min. 17°C, Max. 30°C.  
Fan Only: No temperature indication.
- Press : Select AUTO, LOW , LOW+ , MED , MED+ , HIGH or QUIET .

## 6 AUTOMATIC OPERATION

To automatically select cooling, heating, or fan only operation.

- Press : Select Auto A.
- Press : Set the desired temperature.  
Min. 17°C, Max. 30°C.
- Press : Select AUTO, LOW , LOW+ , MED , MED+ , HIGH or QUIET .

## 7 HEATING AND 8°C OPERATION

- Press : Select Heat .
- Press : Set the desired temperature.  
Min. 5°C, Max. 30°C.  
Temperature range 5-16°C is Heat mode with 8°C operation with less of energy usage.
- Press : Select AUTO, LOW , LOW+ , MED , MED+ , HIGH or QUIET .

### NOTE

During 8°C mode active (temperature range 5-16°C), some operation such as QUIET, Hi POWER, TIMER OFF cannot use.

## 8 DRY OPERATION

For dehumidification, a moderate cooling performance is controlled automatically.

1. Press : Select Dry .
2. Press : Set the desired temperature.  
Min. 17°C, Max. 30°C.

### NOTE

DRY mode fan speed is set to Auto only.

## 9 MENU SETUP

For select more setting of Air conditioner such as Silent, Hi Power, OFF Timer and other use MENU button .

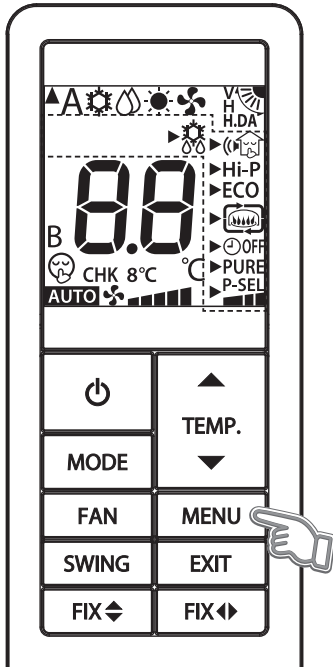

## 9.1 STRONG DEFROST OPERATION



Upgrade defrost ability when normal defrost ability is not enough by increase defrosting finished operation.

1. Press MENU button to enter menu setting and press TEMP. button to select Strong defrost feature.

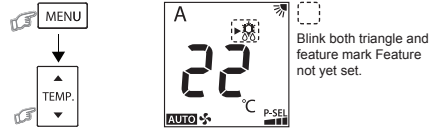

2. Confirm selected feature by press MENU button again.

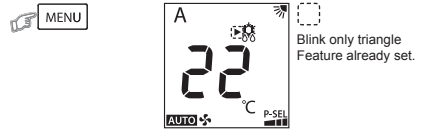

When feature had selected will return to menu selection display triangle mark will blink .

3. Leave from menu setting display by press EXIT button.

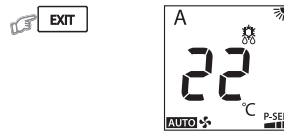

### NOTE

- Strong defrost will operate only in Auto and Heat mode.

## 9.2 SILENT OPERATION (Outdoor Unit)



Keep outdoor unit operating silently to ensure either yourself or neighborhood will have a tight sleep in nighttime. By this feature, the Cooling or Heating capacity will be optimized to deliver such silent experience. The silent operation can be selected from one of two purposes (Silent 1 and Silent 2). There are three setting parameters: Standard level > Silent 1 > Silent 2.

### Silent 1:



- Though operating silently, the Cooling or Heating capacity is still prioritized to ensure having sufficient comfort inside the room.
- This setting is a perfect balance between the Cooling or Heating capacity and the Sound level of outdoor unit.

### Silent 2:



- Compromising the Cooling or Heating capacity to the Sound level in any circumstance where the outdoor unit's sound level is highly prioritized.
- This setting has a purpose to reduce the maximum sound level of outdoor unit by 4dB(A).

### NOTE

- While activating of Silent operation, inadequate Cooling or Heating capacity may occur.

## Silent Operation Setting

1. Press MENU button for enter menu setting and press TEMP. button to select Silent.

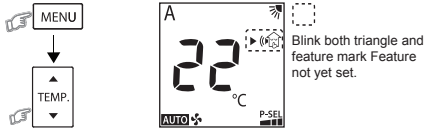

2. Enter SILENT set by press MENU button. triangle mark will stop blink and setting feature will be blink instead.

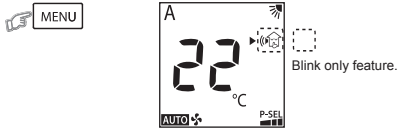

3. Select SILENT operation by press TEMP. button.

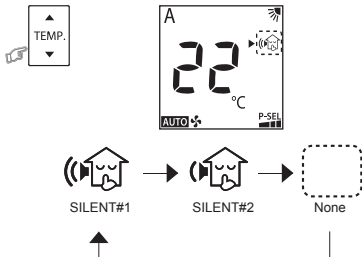

4. Confirm selected feature by press MENU button again.

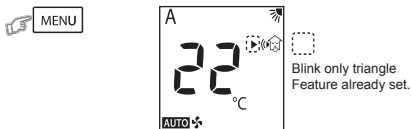

When feature had selected will return to menu selection display triangle mark will blink

5. Leave from menu setting display by press EXIT button.

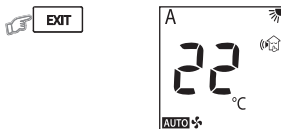

## 9.3 Hi POWER OPERATION

# Hi-P

To automatically control room temperature and airflow for faster cooling or heating operation (except in DRY and FAN ONLY mode).

1. Press MENU button for enter menu setting and press TEMP. button to select Hi POWER.

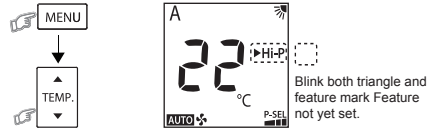

2. Confirm selected feature by press MENU button again.

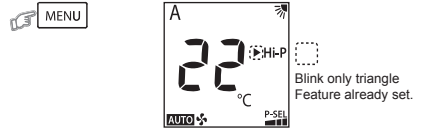

When feature had selected will return to menu selection display triangle mark will blink

3. Leave from menu setting display by press EXIT button.

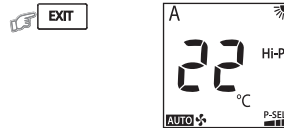

## 9.4 ECO OPERATION

# ECO

To automatically control room temperature to save energy (except in DRY and FAN ONLY mode).

1. Press MENU button for enter menu setting and press TEMP. button to select ECO.

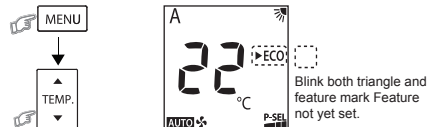

2. Confirm selected feature by press MENU button again.

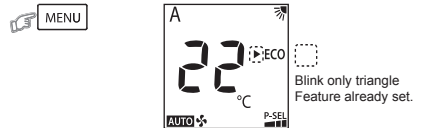

When feature had selected will return to menu selection display triangle mark will blink

3. Leave from menu setting display by press EXIT button.

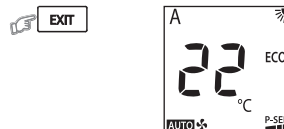

## NOTE

- Cooling operation; the set temperature will increase automatically 1 degree/hour for 2 hours (maximum 2 degrees increase). For heating operation the set temperature will decrease.

## 9.5 FIREPLACE OPERATION



Keep indoor unit's fan blowing continuously during thermo off, to circulate heat from other sources over the room. There are three setting parameters: Default setting > Fireplace 1 > Fireplace 2.

### Fireplace 1:



- During thermo off period, the indoor unit's fan will continue to run by the same speed, previously selected by end-user.

### Fireplace 2:



- During thermo off period, the indoor unit's fan will continue to run at super-low speed, programmed from factory.

### Fireplace Operation Setting

1. Press MENU button for enter menu setting and press TEMP. button to select FIREPLACE.

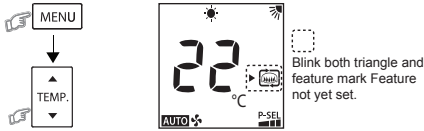

2. Enter FIREPLACE set by press MENU button. triangle mark will stop blink and setting feature will be blink instead.

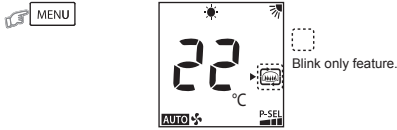

3. Select FIREPLACE operation by press TEMP. button.

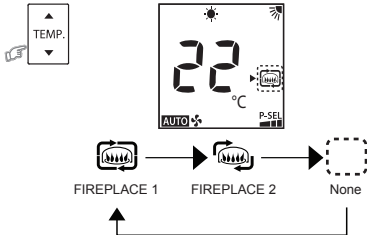

4. Confirm selected feature by press MENU button again.

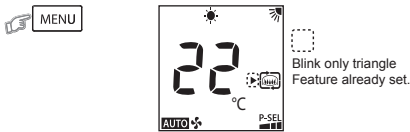

When feature had selected will return to menu selection display triangle mark will blink.

5. Leave from menu setting display by press EXIT button.

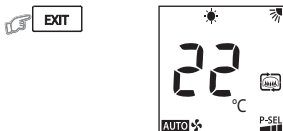

### NOTE

- While Fireplace operation on heating mode, indoor unit fan always runs and cold air breezing might be occurred.
- Fireplace will operate in Heating mode only.
- Fireplace doesn't work with IMS multi system combination.

## 9.6 TIMER OFF OPERATION



To set the timer OFF when the air conditioner is operating.

1. Press MENU button for enter menu setting and press TEMP. button to select TIMER OFF.

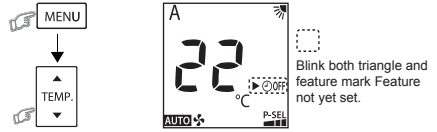

2. Enter TIMER set by press MENU button. triangle mark will stop blink and setting feature will be blink instead.

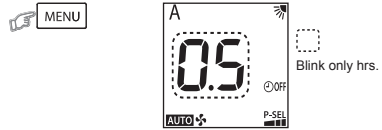

3. Select TIMER OFF by press TEMP. button. Can select TIMER OFF from 0.5 - 12 hrs.

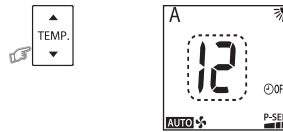

4. Confirm TIMER OFF by press MENU button.

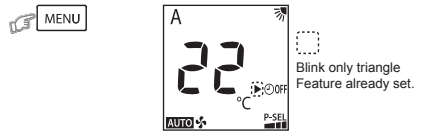

When feature had selected will return to menu selection display triangle mark will blink.

5. Leave from menu setting display by press EXIT button.

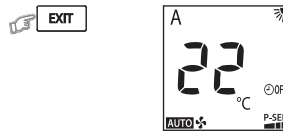

### NOTE

- The setting will be saved for the next same operation.

### Cancel TIMER OFF

6. During TIMER OFF already set (no.5) press MENU button and press TEMP. button to select TIMER OFF.

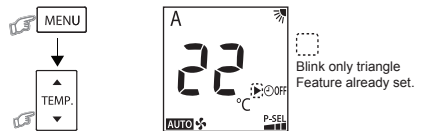

7. Press MENU button again will cancel TIMER OFF.

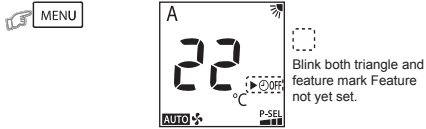

8. Leave from menu setting display by press EXIT button.

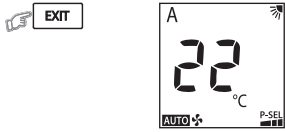

## 9.7 PURE (IONIZER) OPERATION

## PURE

Capture efficiency of floating impurities in the air is accelerated by ionizer contaminates such as bacteria, odor, smoke, dust and virus are caught and deactivated by ionizer.

1. Press MENU button for enter menu setting and press TEMP. button to select PURE.

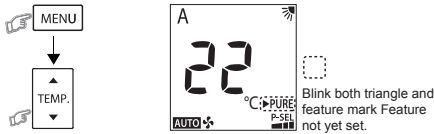

2. Confirm selected feature by press MENU button again.

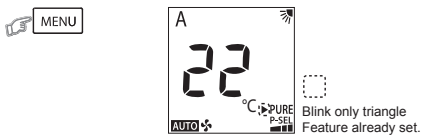

When feature had selected will return to menu selection display triangle mark will blink

3. Leave from menu setting display by press EXIT button.

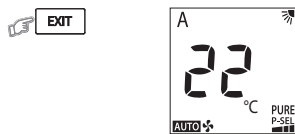

### NOTE

- Ionizer operation does not remove harmful substances from cigarette smoke (carbon monoxide etc.). Open a window occasionally for ventilation.
- Built up of dirt, smoke, or an extremely humid environment might cause the ionizer operation to be malfunction. In that case, cleaning the air-con and let it dry prior operation are recommended.

## 9.8 POWER-SELECTION OPERATION

## P-SEL

This function is used when the circuit breaker is shared with other electrical appliances. It limits the maximum current and power consumption to 100%, 75%, or 50% and can be implemented by POWER-SELECTION. The lower percentage, the higher saving and also longer compressor lifetime.

### NOTE

- Due to the reason that POWER-SELECTION function limits the maximum current, inadequate cooling or heating capacity may occur.

1. Press MENU button for enter menu setting and press TEMP. button to select POWER-SEL.

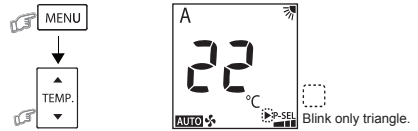

2. Enter POWER-SEL setting by press MENU button again.

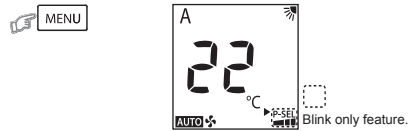

3. Select POWER-SEL level by press TEMP. button.

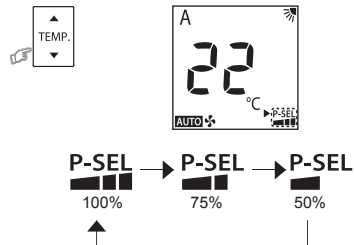

4. Confirm POWER-SEL level by press MENU button.

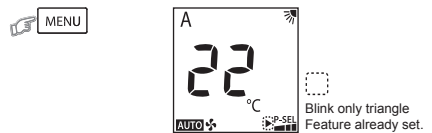

When feature had selected will return to menu selection display triangle mark will blink

5. Leave from menu setting display by press EXIT button.

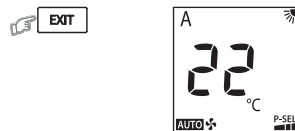

## 10 MANUAL DEFROST OPERATION

To defrosting the heat exchanger of the outdoor unit during Heating operation.  
Press and hold : for 5 seconds, then remote control display will show dF as picture ① for 2 seconds.

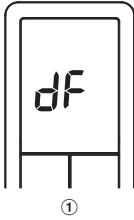

## 11 DISPLAY LAMP BRIGHTNESS ADJUSTMENT

To decrease the display lamp brightness or turn it off.

- Press and hold for 3 seconds until brightness level (d0, d1, d2 or d3) is shown on remote controller LCD then release the button.
- Press Rise or Decrease : to adjust brightness in 4 levels.

Remote controller LCD	Operation display	Brightness
d3	 Lamp illuminates full brightness.	100%
d2	 Lamp illuminates 50% brightness.	50%
d1	 Lamp illuminates 50% brightness and the operation lamp is turned off.	50%
d0	 All lamps are turned off.	All turned off

- In the examples of d1 and d0 the lamp illuminates for 5 seconds before going off.

## 12 AUTO RESTART FUNCTION SETTING

This product is designed so that, after a power failure, it can restart automatically in the same operating mode as before the power failure.

### INFORMATION

The product is shipped with Auto Restart function in the ON position. Turn it OFF if this function is not required.

#### How to turn OFF the Auto Restart Function

- Press and hold the [RESET] button on the indoor unit for 3 seconds (3 beep sounds but OPERATION lamp does not blink).

#### How to turn ON the Auto Restart Function

- Press and hold the [RESET] button on the indoor unit for 3 seconds (3 beep sounds and OPERATION lamp blink 5 time/sec for 5 seconds).

### NOTE

- In case of ON timer or OFF timer are set, AUTO RESTART OPERATION does not activate.

## 13 SELF CLEANING OPERATION (COOL AND DRY OPERATION ONLY)

To protect bad smell caused by the humidity in the indoor unit.

- If the button is pressed once during "Cool" or "Dry" mode, the fan will continue to run for other 30 minutes, then it will turn off automatically. This will reduce the moisture in the indoor unit.
- To stop the unit immediately, press the more 2 times with in 30 seconds.

## 14 TEMPORARY OPERATION

In case of the misplaced or discharged remote controller.

- Pressing the RESET button, the unit can start or stop without using the remote controller.
- Operation mode is set on AUTOMATIC operation, preset temperature is 24°C and fan operation is automatic speed.

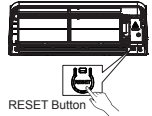

## 15 REMOTE CONTROLLER A-B SELECTION

To separate using of remote controller for each indoor unit in case of 2 air conditioners are installed nearby.

### Remote controller B setup

- Press RESET button on the indoor unit to turn the air conditioner ON.
- Point the remote controller at the indoor unit.
- Push and hold button on the back side of Remote Control "00" will be shown on the display. (Picture ①)
- Press during pushing "B" will show on the display and "00" will disappear and the air conditioner will turn OFF. The Remote Controller B is memorized. (Picture ②)

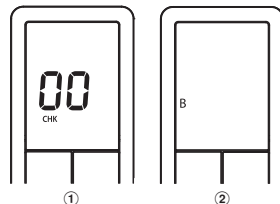

### NOTE

- Repeat above step to reset Remote Control to be A.
- Remote Control A has not "A" display.
- Default setting of Remote Control from factory is A.

## 16 OPERATION AND PERFORMANCE

1. Three-minute protection feature: To prevent the unit from being activated for 3 minutes when suddenly restarted or switched to ON.
2. Preheating operation: Warm up the unit for 5 minutes before the heating operation starts.
3. Warm air control: When the room temperature reaches the set temperature, the fan speed is automatically reduced and the outdoor unit will stop.
4. Automatic defrosting: Fans will stop during defrost operation.
5. Heating capacity: Heat is absorbed from outdoors and released into the room. When the outdoor temperature is too low, use another recommended heating apparatus in combination with the air conditioner.
6. Consideration for accumulated snow: Select the position for outdoor unit where it will not be subjected to snow drifts, accumulation of leaves or other seasonal debris.
7. Some minor cracking sound may occur when unit operating. This is normal because the cracking sound may be caused by expansion/contraction of plastic.

### NOTE

- Item 2 to 6 for Heating model.

#### Air conditioner operating conditions

Operation	Temp.	Outdoor Temperature	Room Temperature
Heating		-20°C ~ 24°C	0°C ~ 28°C
Cooling		-15°C ~ 46°C	21°C ~ 32°C
Dry		-15°C ~ 46°C	17°C ~ 32°C

\* If connected to multiple type, please refer to information provided with outdoor unit.

## 17 MAINTENANCE

### CAUTION

- Firstly, turn off the circuit breaker.

### Indoor Unit and Remote Controller

- Clean the indoor unit and the remote controller with a wet cloth when needed.
- No benzene, thinner, polishing powder or chemically-treated duster.

### Air Filters

Clean every 2 weeks.

1. Open the air inlet grille.
2. Remove the air filters.
3. Vacuum or wash and then dry them.
4. Reinstall the filters and close the air inlet grille.

## 18 TROUBLESHOOTING (CHECK POINT)

The unit does not operate.	Cooling or Heating is abnormally low.
<ul style="list-style-type: none"> <li>• The power main switch is turned off.</li> <li>• The circuit breaker is activated to cut off the power supply.</li> <li>• Stoppage of electric current.</li> <li>• ON timer is set.</li> </ul>	<ul style="list-style-type: none"> <li>• The filters are blocked with dust.</li> <li>• The temperature has been set improperly.</li> <li>• The windows or doors are opened.</li> <li>• The air inlet or outlet of the outdoor unit is blocked.</li> <li>• The fan speed is too low.</li> <li>• The operation mode is FAN or DRY.</li> <li>• POWER SELECTION function is set 75% or 50% (<b>This function is depend on remote controller</b>).</li> </ul>

# 19 WIRELESS LAN CONNECTION

## Toshiba Home AC Control

Please visit the application store on your device to download and install Toshiba Home AC Control application.



### Application

Keyword : Toshiba Home AC Control

## About Toshiba Home AC Control

1. Toshiba Home AC Control can control AC operation by Smartphone or tablet (mobile device) via internet connection.
2. Everywhere control, control software run on Cloud system and mobile device can set and monitor AC operation via internet connection.
3. Everyone can control, 1 Wireless adapter maximum 5 User (use 1 email register).
4. Multi AC system control, 1 user can control 16 AC.
  - 5.1 Can create and control 3 groups of AC.
  - 5.2 Can control max 16 AC per group.
5. Group control.

## Toshiba Home AC Control application support



iOS : 9.0 or later.



Android : Version 5.0 or later.

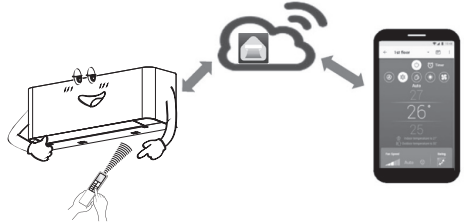

## NOTE

1. Adapter can register only 1 email address, if register with new email, current email will be invalid.
2. 1 email address can use for register 5 devices for control same AC.

## Register process

Open an application and follow register for User registration.

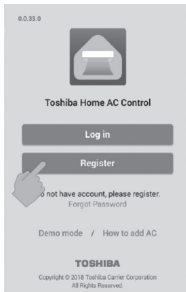

1 Tab Register.

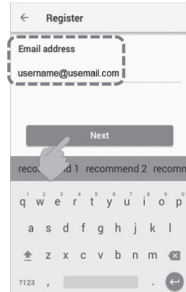

2 Enter email address.

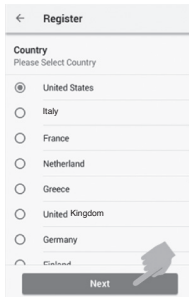

3 Select country.

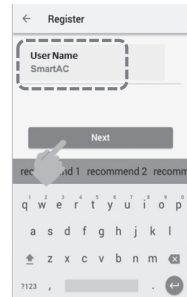

4 Enter user name.

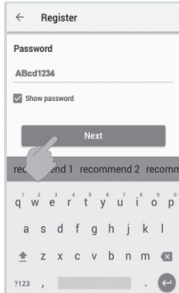

5 Enter password by 6-10 characters, combination of alphabet and number.

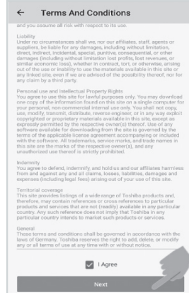

6 Check for term and condition.

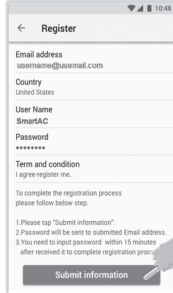

7 Confirm information.



8 Information will be submitted to email, click link to confirm.

## Log in to Toshiba Home AC Control application

- 1 Connect Wireless adapter to A/C and turn on power supply.

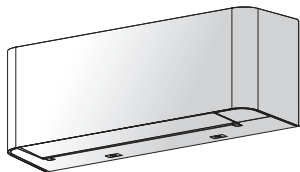

Built-in type, Wireless adapter already install with unit.

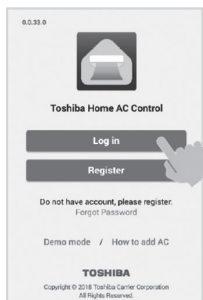

- 2 Open application and select Log in.



- 3 Enter user name and password.

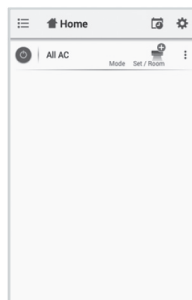

- 4 Login successful.

## Add Wireless adapter for control by Toshiba Home AC Control application

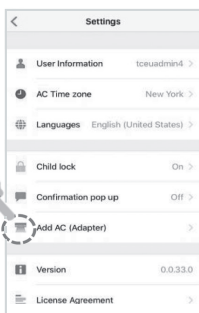
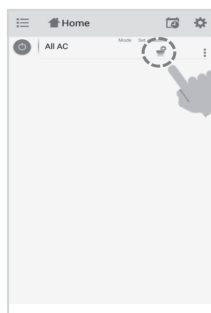

- 1 Select "Add AC (Adapter)" from both display above.

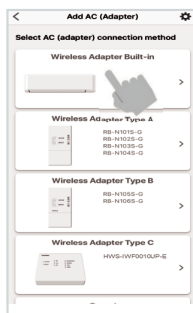

Wireless adapter Built-in  
Active Wireless adapter by remote controller and Auto login.

- 2 Select AC (adapter) connection method.

## NOTE

In case of Wi-Fi router, SSID & password of Wi-Fi router, registered email or wireless adapter change, user need to factory reset and re-process for adding wireless adapter again.

### 1. Factory reset process

Built-in type: Press MODE button at remote controller for 5S and press TEMP. DOWN 1 time then active "dL" mode by pressing MODE button again.

### 2. Adding wireless adapter process

Built-in type: Press MODE button at remote controller for 5S to active "AP" mode.

**Add Wireless adapter for control by Toshiba Home AC Control application**

③ AC (adapter) connect.

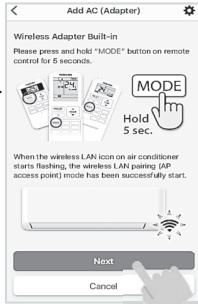
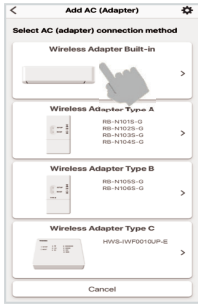

Press and hold MODE button 5 seconds

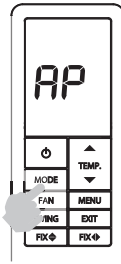

④ Active Wireless adapter by Remote controller.

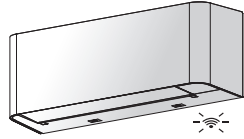

Wireless LED mark will blink when AP mode active



⑤ Connect with Home Wi-Fi Router.

⑥ A/C add finished.

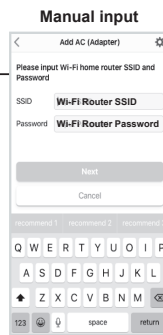
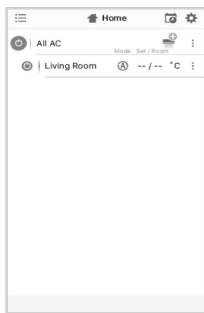

⑦ Connect successfully.

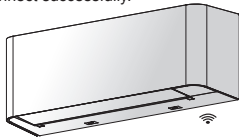

Wireless LED lamp stop blink.

Home screen

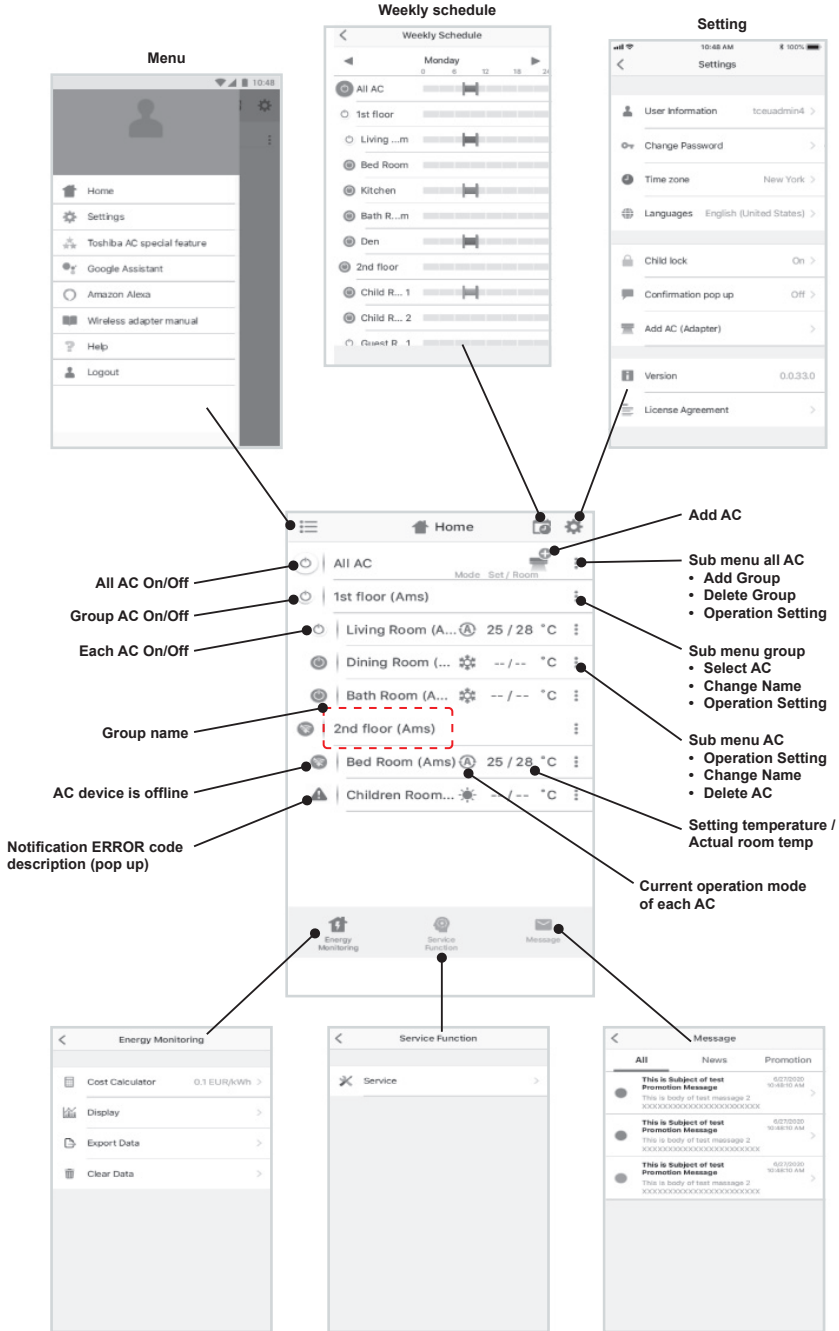

## Mode and Condition setting

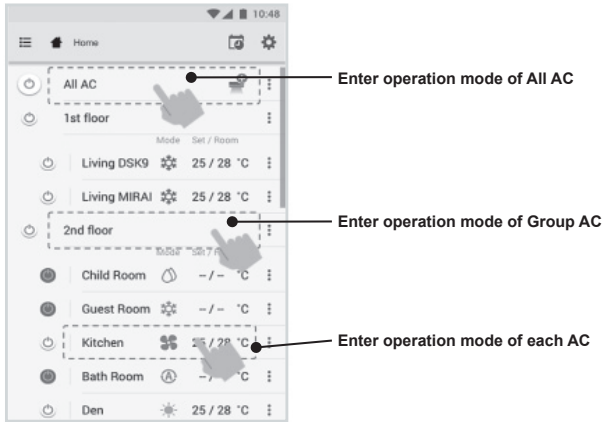

## Mode select for Toshiba Home AC Control application

Provide for 5 operation modes



\* This "Heat mode" is available for Heat Pump product.

Setting in operation mode

**Tab for select AC**

**Weekly schedule**

**Mode select**

**OFF-ON Timer set**

**Temperature set**

**Indoor temperature**

**Outdoor temperature**

**Fan speed set**

**Louver set**

**Special feature**

**OFF-ON timer set 0.5-12 hrs.**

**Off Timer**  
Please Select hour

- 0.5
- 1.0
- 1.5
- 2.0
- 2.5
- 3.0

CANCEL START

**On Timer**  
Please Select hour

- 0.5
- 1.0
- 1.5
- 2.0
- 2.5
- 3.0

CANCEL START

**ON timer set from Off mode only**

**Off mode**

## Group operation

Maximum 3 groups  
1 Group maximum = 16 units.

### Add group

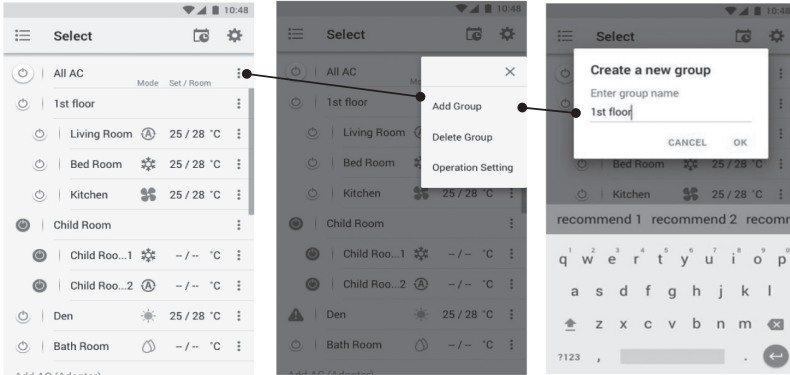

### Add AC in group

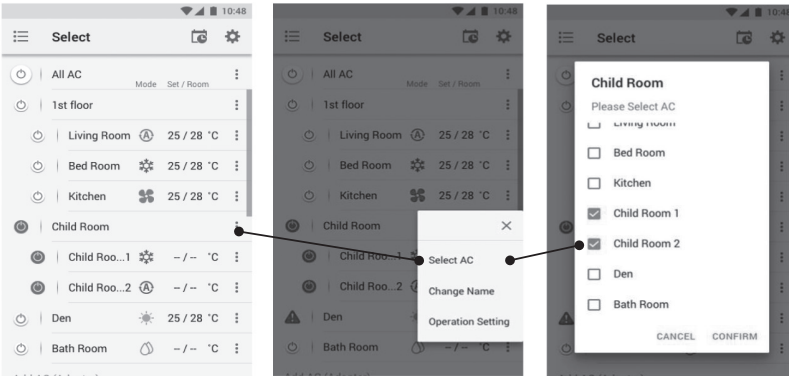

### Delete AC in group

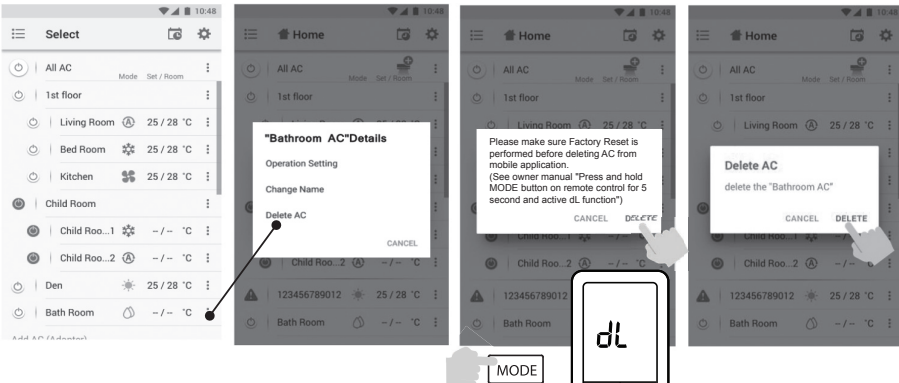

**Weekly schedule set**

Day select Monday - Sunday

Weekly schedule of all AC unit

Weekly schedule of all AC unit

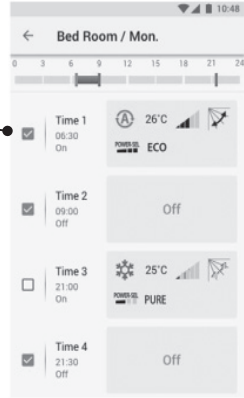
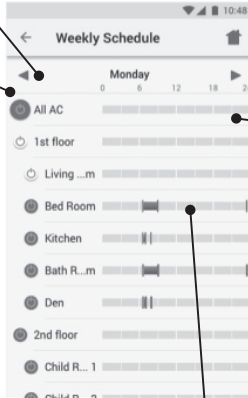
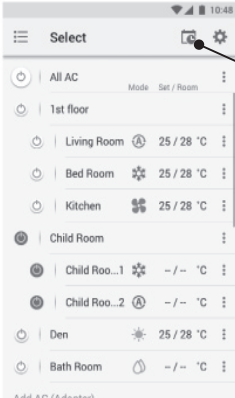

Time select

Weekly schedule set for each unit

Mode select

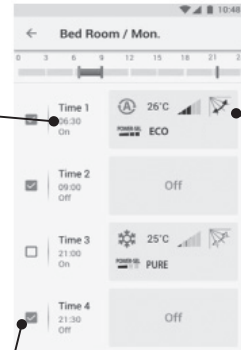

Select program for active by tick at select box

**Weekly schedule cancel**

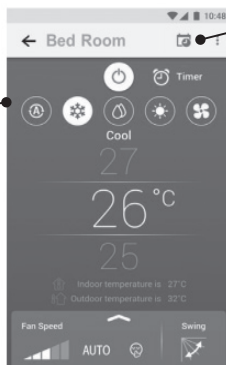
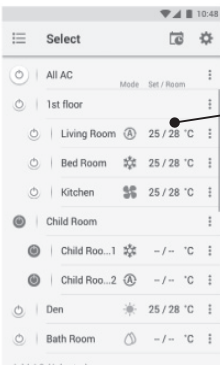

Weekly schedule not set

Weekly schedule set but not active

Weekly schedule set and active

Select Room for Energy monitoring

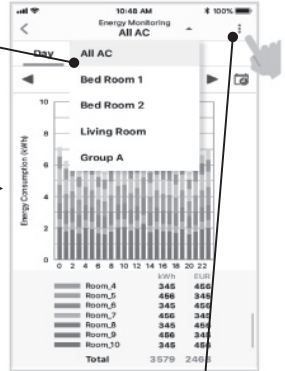
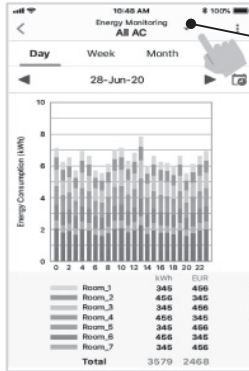
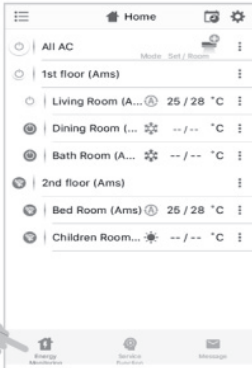

- ① Select Energy monitoring.
- ② Energy monitoring display.

Set cost calculate and currency

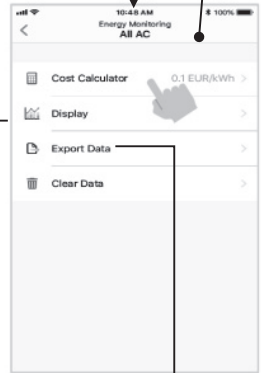
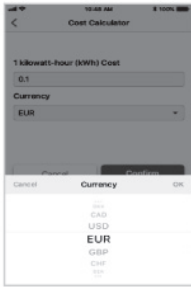

Set cost calculate and currency

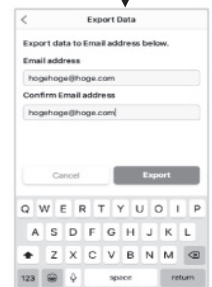
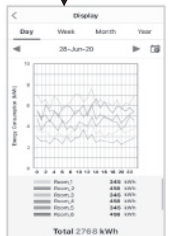
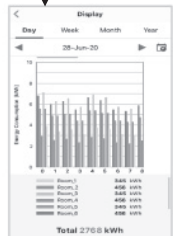
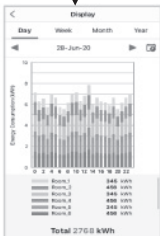

Export data and send by Email

- The power consumption displayed is just an estimate as it is calculated simply. It may sometimes differ from the result measured by the power meter.

In case of have some problem can check from Help menu

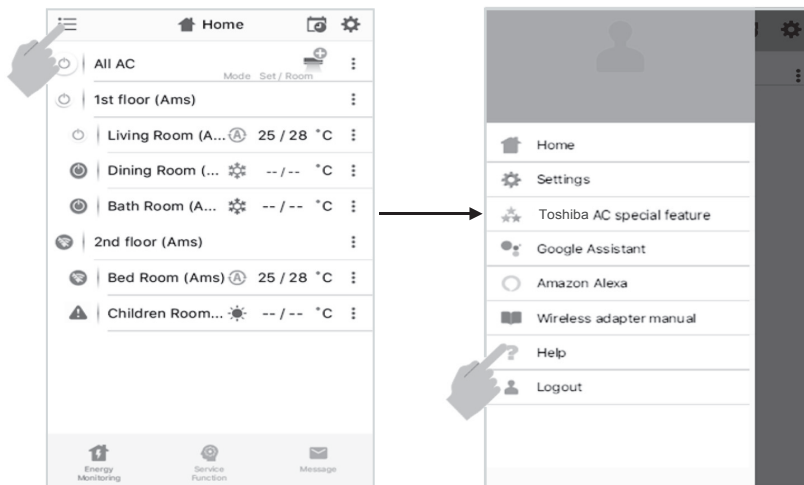

#### NOTE

- The Wireless Adapter must be installed, maintained, repaired and removed by a qualified installer or qualified service person.
- Contact dealer and/or service center when equipment is malfunction.

# **TOSHIBA**

**CARRIER AIR CONDITIONING (THAILAND) CO., LTD.**

144/9 MOO 5, BANGKADI INDUSTRIAL PARK, TIVANON ROAD, TAMBOL BANGKADI, AMPHUR MUANGPATHUMTHANI, PATHUMTHANI 12000, THAILAND