



Test Report issued under the responsibility of:



TEST REPORT IEC 60335-2-40 Safety of household and similar electrical appliances Part 2-40: Particular requirements for electrical heat pumps, air conditioners and dehumidifiers	
Report Number :	19012779BKK-001
Date of issue	3 April 2019
Total number of pages	244 pages
Name of Testing Laboratory preparing the Report	Intertek Testing Services (Thailand) Ltd.
Applicant's name	Toshiba Carrier (Thailand) Co., Ltd.
Address :	144/9 Moo5, Bangkadi Industrial Park, Tivanon Road, Tambol Bangkadi, Amphur Muang, Pathumthani 12000, Thailand.
Test specification:	
Standard	IEC 60335-2-40:2018 in conjunction with IEC 60335-1:2010, AMD1:2013, AMD2:2016
Test procedure	CB Scheme
Non-standard test method	N/A
Test Report Form No.	IEC60335_2_400
Test Report Form(s) Originator :	VDE Testing and Certification Institute
Master TRF	Dated 2018-04-05
Copyright © 2018 IEC System of Conformity Assessment Schemes for Electrotechnical Equipment and Components (IECEE System). All rights reserved.	
This publication may be reproduced in whole or in part for non-commercial purposes as long as the IECEE is acknowledged as copyright owner and source of the material. IECEE takes no responsibility for and will not assume liability for damages resulting from the reader's interpretation of the reproduced material due to its placement and context.	
If this Test Report Form is used by non-IECEE members, the IECEE/IEC logo and the reference to the CB Scheme procedure shall be removed.	
This report is not valid as a CB Test Report unless signed by an approved CB Testing Laboratory and appended to a CB Test Certificate issued by an NCB in accordance with IECEE 02.	
General disclaimer:	
The test results presented in this report relate only to the object tested. This report shall not be reproduced, except in full, without the written approval of the Issuing CB Testing Laboratory. The authenticity of this Test Report and its contents can be verified by contacting the NCB, responsible for this Test Report.	

Test item description	Split Type Air Conditioners
Trade Mark	TOSHIBA
Manufacturer.....	Same as applicant
Model/Type reference	Indoor unit: i) RAS-B*J2KVRG-E (Where "*" Can be 10, 13, 16, 22, 24) ii) RAS-18J2KVRG-E iii) RAS-*J2KVRG-TR (Where "*" Can be 10, 13, 16, 18, 22, 24) iv) RAS-24PKVSG-EE Outdoor unit: i),ii) RAS-*J2AVRG-E iii) RAS-*J2AVRG-TR (Where "*" Can be 10, 13, 16, 18, 22, 24) iv) RAS-24PAVSG-EE
Ratings	220V-240V, 1 Phase, 50Hz; Class I ; R32

Responsible Testing Laboratory (as applicable), testing procedure and testing location(s):		
<input checked="" type="checkbox"/>	CB Testing Laboratory:	Intertek Testing Services (Thailand) Ltd.
Testing location/ address		1285/5 Prachachuen Rd., Wongsawang, Bangsue, Bangkok, 10800 THAILAND
Tested by (name, function, signature)		Surasak Khuikha (Test Engineer)
Approved by (name, function, signature) ..		Peerapon Sintuaus (Reviewer)
<hr/>		
<input type="checkbox"/>	Testing procedure: CTF Stage 1:	
Testing location/ address		N/A
Tested by (name, function, signature)		N/A
Approved by (name, function, signature) ..		N/A
<hr/>		
<input type="checkbox"/>	Testing procedure: CTF Stage 2:	
Testing location/ address		N/A
Tested by (name + signature)		N/A
Witnessed by (name, function, signature) .		N/A
Approved by (name, function, signature) ..		N/A
<hr/>		
<input type="checkbox"/>	Testing procedure: CTF Stage 3:	
<input type="checkbox"/>	Testing procedure: CTF Stage 4:	
Testing location/ address		N/A
Tested by (name, function, signature)		N/A
Witnessed by (name, function, signature) .		N/A
Approved by (name, function, signature) ..		N/A
Supervised by (name, function, signature) :		N/A

<p>List of Attachments (including a total number of pages in each attachment):</p> <p>a) Attachment No.1: EUROPEAN GROUP DIFFERENCES AND NATIONAL DIFFERENCES (16 page)</p> <p>b) Attachment No.2: Amendment 13 of EN 60335-1 (EN 60335-1:2012/A13:2017) (1page)</p> <p>c) Attachment no. 3: AC:2013 of EN 60335-2-40:2003 (1page)</p> <p>d) Attachment no. 4: Unit picture (34 page)</p>	
<p>Summary of testing:</p>	
<p>Tests performed (name of test and test clause):</p> <p>Clause 7 : Marking and instructions</p> <p>Clause 8 : Protection against access to live parts</p> <p>Clause 10 : Power input and current</p> <p>Clause 11 : Heating</p> <p>Clause 13 : Leakage current and electric strength at operating temperature</p> <p>Clause 15 : Moisture resistance</p> <p>Clause 16 : Leakage current and electric strength</p> <p>Clause 19 : Abnormal operation</p> <p>Clause 20 : Stability and mechanical hazards</p> <p>Clause 21 : Mechanical strength</p> <p>Clause 22 : Construction</p> <p>Clause 23 : Internal wiring</p> <p>Clause 24 : Components</p> <p>Clause 25 : Supply connection and external flexible cords</p> <p>Clause 26 : Terminals for external conductors</p> <p>Clause 27 : Provision for earthing</p> <p>Clause 28 : Screws and connections</p> <p>Clause 29 : Clearances, Creepage distances and Solid insulation</p> <p>Clause 30 : Resistance to heat and fire</p> <p>Clause 31 : Resistance to rusting</p>	<p>Testing location:</p> <p>Intertek Testing Services (Thailand) Ltd. 1285/5, Prachachuen Rd., Wongsawang, Bangsue, Bangkok 10800 THAILAND</p>
<p>Summary of compliance with National Differences (List of countries addressed):</p> <ul style="list-style-type: none"> - Group and national differences for CENELEC <input checked="" type="checkbox"/> The product fulfils the requirements of <ul style="list-style-type: none"> - IEC 60335-2-40:2018 - IEC 60335-1:2010, AMD1:2013, AMD2:2016 - IEC 62233:2005 - EN 60335-2-40:2003 + A11:2004 + A12: 2005 + A1: 2006 + A2: 2009 + A13: 2012 - EN 60335-1:2012+A11:2004 + A13:2017 - EN 62233:2008 	

Copy of marking plate: Outdoor unit (Representative)

TABLE 1					
AIR CONDITIONER					
Model :	[] (A)				
Serial No.	[] Printing the serial no.				
Net weight	[] (B) kg				
Power supply					
[] (C)					
Power	Max.	[] (D)			kW
Current	Max.	[] (E)			A
COP.	Cool	[]			
	Heat	[]			
Capacity	Cool	[]			kW
	Heat	[]			kW
Power	Cool	[]			kW
	Heat	[]			kW
Current	Cool	[]			A
	Heat	[]			A
Capacity and input were measured under following conditions;					
		Indoor temp.		Outdoor temp.	
		D.B.	W.B.	D.B.	W.B.
Cooling		27°C	19°C	35°C	24°C
Heating		20°C	15°C	7°C	6°C
The WIRING DIAGRAM is located on top of the electrical parts box.					
R32	[] (F) kg				
MAXIMUM OPERATING PRESSURE					
Hi 4.29 / Lo 2.26 MPa					
Hi 42.9 / Lo 22.6 bar					
PIPE LENGTH	[] m				
CHARGELESS PIPE LENGTH	[] m				
PIPE LENGTH	[] m				
: 20g/m (ADDITIONAL REFRIGERANT)					
PIPING HEIGHT DIFFERENCE	[] m				
REFRIGERANT					
R32					
Contains fluorinated gases.					
TOSHIBA CARRIER (THAILAND) CO.,LTD.					
MADE IN THAILAND					
IPX4	10720860 (Gr)				

Outdoor unit Type 1

TABLE 1	
KLİMA	
[] (A)	
[] (B)	
	[] (C) kW
R32	[] (D) kg
IPX4	4.29 / 2.26 MPa
	42.9 / 22.6 bar
	[] (E) kg
SERİ NUMARASI	[] Printing the serial no.
Üretim yılı	[] Printing the manufacture year.
Detaylı bilgi için lütfen kataloğa bakınız	
TOPLAM BORULAMA MESAFESİ	[] m
ŞARJSIZ BORULAMA MESAFESİ	[] m
TOPLAM BORULAMA MESAFESİ	[] m
	[] m
BORULAMA YÜKSEKLİK FARKI	[] m
SOĞUTUCU AKIŞKAN	
R32	
Florlu sera gazı içerir.	
•Kablolama şeması, elektrikli parçalar kısmı üzerindedir.	
TOSHIBA CARRIER (THAILAND) CO.,LTD.	
ÜRETİM YERİ TAYLAND	
	10720877 (Gr)

Outdoor unit Type 2

Copy of marking plate: Outdoor unit (Representative)

TOSHIBA	
AIR CONDITIONER	
Model :	<input type="text"/> (A)
Serial No.	Printing the serial no. <input type="text"/>
Net weight	<input type="text"/> (B) kg
Power supply	
	<input type="text"/> (C)
Power Max.	<input type="text"/> (D) kW
Current Max.	<input type="text"/> (E) A
COP, Cool	<input type="text"/>
Heat	<input type="text"/>
Capacity Cool	<input type="text"/> kW
Heat	<input type="text"/> kW
Power Cool	<input type="text"/> kW
Heat	<input type="text"/> kW
Current Cool	<input type="text"/> A
Heat	<input type="text"/> A
Capacity and input were measured under following conditions;	
	Indoor temp. Outdoor temp.
	D.B. W.B. D.B. W.B.
Cooling	27°C 19°C 35°C 24°C
Heating	20°C 15°C 7°C 6°C
The WIRING DIAGRAM is located on top of the electrical parts box.	
R32	<input type="text"/> (F) kg
MAXIMUM OPERATING PRESSURE	
Hi 4.29 / Lo 2.26	MPa
Hi 42.9 / Lo 22.6	bar
PIPE LENGTH	<input type="text"/> m
CHARGELESS PIPE LENGTH	<input type="text"/> m
PIPE LENGTH	<input type="text"/> m
: 20g/m (ADDITIONAL REFRIGERANT)	
PIPING HEIGHT DIFFERENCE	<input type="text"/> m
REFRIGERANT	
R32	
Contains fluorinated gases.	
	
TOSHIBA CARRIER (THAILAND) CO.,LTD.	
MADE IN THAILAND	
IPX4	10720854(G)
EAC	

Outdoor unit Type 3

Total Quality. Assured.

Copy of marking plate for Outdoor unit:						
Type	A	B	C	D	E	F
1	RAS-10J2AVRG-E	28	220-240V, 50Hz	1,440	6,75	0,51
	RAS-13J2AVRG-E	28	220-240V, 50Hz	1,580	7,35	0,67
	RAS-16J2AVRG-E	34	220-240V, 50Hz	1,995	8,95	0,80
	RAS-18J2AVRG-E	34	220-240V, 50Hz	2,030	9,50	1,10
	RAS-22J2AVRG-E	34	220-240V, 50Hz	2,220	10,50	1,10
	RAS-24J2AVRG-E	41	220-240V, 50Hz	2,670	12,80	1,14





Copy of marking plate for Outdoor unit:					
Type	A	C	D	E	F
2	RAS-10J2AVRG -TR	220-240V, 50Hz	1,440	0,51	28
	RAS-13J2AVRG -TR	220-240V, 50Hz	1,580	0,67	28
	RAS-16J2AVRG -TR	220-240V, 50Hz	1,955	0,80	34
	RAS-18J2AVRG -TR	220-240V, 50Hz	2,030	1,10	34
	RAS-22J2AVRG -TR	220-240V, 50Hz	2,220	1,10	34
	RAS-24J2AVRG -TR	220-240V, 50Hz	2,670	1,14	41

Copy of marking plate for Outdoor unit:						
Type	A	B	C	D	E	F
3	RAS-24PAVSG-EE	41	220-240V, 50Hz	2,670	12,80	1,14





Copy of marking plate: indoor unit (Representative)

<p>TOSHIBA AIR CONDITIONER</p> <p>A</p>  <p>SERIAL NO. _____</p> <p>B</p> <p>C</p> <p>D kg E</p>	<p>Details of specification, Please see attached specification sheet or label of outdoor unit.</p> <p>TOSHIBA CARRIER (THAILAND)CO.,LTD.</p> <p>MADE IN THAILAND</p>   	<p>Name of manufacturer TOSHIBA CARRIER (THAILAND) CO.,LTD. Address, city, country 144/9 Moo 5, Bangkadi Industrial Park, Tivanon Road, Tambol Bangkadi, Amphur Muang, Pathumthani 12000, Thailand</p> <p>Name of importer/Distributor in EU TOSHIBA CARRIER EUROPE S.A.S Address, city, country Route de Thil 01120 Montluel FRANCE</p>	 <p>10720492</p>
---	--	--	---

Type 1

<p>TOSHIBA</p> <p>KLİMA</p> <p>A</p>  <p>SERİ NUMARASI. _____</p> <p>B</p> <p>C</p> <p>D kg E</p>	<p>Detaylı bilgi için lütfen teknik özellikler tablosuna veya dış ünite etiketine bakınız.</p> <p>Üretim yılı _____</p> <p>TOSHIBA CARRIER (THAILAND) CO.,LTD.</p> <p>ÜRETİM YERİ TAYLAND</p>	<p>Information for Turkey only: İmalatçı : Toshiba Carrier (Thailand) Co.,Ltd. Adres : 144/9 Moo 5 Bangkadi Industrial Park, Tivanon Rd., A.Muang, Pathumthani 12000</p> <p>İmalatçı Firma: Alarko Carrier San.Tic.A.S. Adres : GOSB-Gebze Organize San.Böl. Sahabettin Bilgisu Cad. Gebze Kocaeli/Türkiye</p>   	 <p>10720494</p>
--	---	---	---

Type 2

<p>TOSHIBA</p> <p>AIR CONDITIONER</p> <p>A</p>  <p>SERIAL NO. _____</p> <p>B</p> <p>C</p> <p>D kg E</p>	<p>Details of specification, Please see attached specification sheet or label of outdoor unit.</p> <p>TOSHIBA CARRIER (THAILAND)CO.,LTD.</p> <p>MADE IN THAILAND</p>    <p>10720492 G</p>
--	--

Type 3

Total Quality. Assured.

Copy of marking plate for indoor unit:					
Type	A	B	C	D	E
1	RAS-B10J2KVRG-E	220-240V~	50Hz	10	40
	RAS-B13J2KVRG-E	220-240V~	50Hz	10	45
	RAS-B16J2KVRG-E	220-240V~	50Hz	10	50
	RAS-18J2KVRG-E	220-240V~	50Hz	15	45
	RAS-B22J2KVRG-E	220-240V~	50Hz	15	50
	RAS-B24J2KVRG-E	220-240V~	50Hz	15	55

Copy of marking plate for indoor unit:					
Type	A	B	C	D	E
2	RAS-10J2KVRG-TR	220-240V~	50Hz	10	40
	RAS-13J2KVRG-TR	220-240V~	50Hz	10	45
	RAS-16J2KVRG-TR	220-240V~	50Hz	10	50
	RAS-18J2KVRG-TR	220-240V~	50Hz	15	45
	RAS-22J2KVRG-TR	220-240V~	50Hz	15	50
	RAS-24J2KVRG-TR	220-240V~	50Hz	15	55

Copy of marking plate for indoor unit:					
Type	A	B	C	D	E
3	RAS-24PKVSG-EE	220-240V~	50Hz	14	55

Test item particulars	Split Type Air Conditioners
Classification of installation and use	Class I; Fixed appliance
Supply Connection	Set of terminals for connection to fixed wiring
.....	
Possible test case verdicts:	
- test case does not apply to the test object	N/A
- test object does meet the requirement	P (Pass)
- test object does not meet the requirement	F (Fail)
Testing	
Date of receipt of test item	07 January 2019
Date (s) of performance of tests	12 January 2019 - 14 February 2019
General remarks:	
The test results presented in this report relate only to the object tested. This report shall not be reproduced, except in full, without the written approval of the Issuing testing laboratory. <i>This report is for the exclusive use of Intertek's Client and is provided pursuant to the agreement between Intertek and its Client. Intertek's responsibility and liability are limited to the terms and conditions of the agreement. Intertek assumes no liability to any party, other than to the Client in accordance with the agreement, for any loss, expense or damage occasioned by the use of this report. Only the Client is authorized to permit copying or distribution of this report and then only in its entirety. Any use of the Intertek name or one of its marks for the sale or advertisement of the tested material, product or service must first be approved in writing by Intertek. The observations and test results in this report are relevant only to the sample tested. This report by itself does not imply that the material, product, or service is or has ever been under an Intertek certification program.</i>	
The measurement uncertainty has been taken into consideration of the test results.	
"(See Enclosure #)" refers to additional information appended to the report. "(See appended table)" refers to a table appended to the report.	
Throughout this report a <input checked="" type="checkbox"/> comma / <input type="checkbox"/> point is used as the decimal separator.	
Manufacturer's Declaration per sub-clause 4.2.5 of IECEE 02:	
The application for obtaining a CB Test Certificate includes more than one factory location and a declaration from the Manufacturer stating that the sample(s) submitted for evaluation is (are) representative of the products from each factory has been provided.....	<input type="checkbox"/> Yes <input checked="" type="checkbox"/> Not applicable
When differences exist; they shall be identified in the General product information section.	
Name and address of factory (ies)	Same as applicant

Total Quality. Assured.

General product information:

The products included in this report are split type air conditioners for Cooling and Heating function, They are class I appliance, The indoor units are wall mounted type, The refrigerant used is R32.

There are two versions based on manufacturer setting wire for main supply connection as following:

- The outdoor units are provided with set of terminals for connection to supply mains by fixed wiring, The indoor units are provided with terminals and to be connected to and supplied from outdoor units.
- The indoor units are provided with set of terminals for connected to supply mains by fixed wiring, The outdoor units are provided with terminals and to be connected to and supplied from indoor units.

Power supply cord was not provided with sample units, However the specification of power supply cord is specified in installation manual, and "Manual: H07RN-F or 60245 IEC66 (1,5 mm² and 2,5 mm² or more) install by Qualified persons," Therefore Power supply cord is not specified in component list table 24.1

The following models are included by this test report.

No	Indoor Unit	Outdoor Unit	Power supply	Maximum Power (A)	Maximum Current (A)	Refrigerant (kg)
1.	RAS-B10J2KVRG-E	RAS-10J2AVRG-E	220-240V~ 50Hz	1,440	6,75	0,51
2.	RAS-10J2KVRG-TR	RAS-10J2AVRG-TR		1,440	6,75	0,51
3.	RAS-B13J2KVRG-E	RAS-13J2AVRG-E		1,580	7,35	0,67
4.	RAS-13J2KVRG-TR	RAS-13J2AVRG-TR		1,580	7,35	0,67
5.	RAS-B16J2KVRG-E	RAS-16J2AVRG-E		1,995	8,95	0,80
6.	RAS-16J2KVRG-TR	RAS-16J2AVRG-TR		1,995	8,95	0,80
7.	RAS-18J2KVRG-E	RAS-18J2AVRG-E		2,030	9,50	1,10
8.	RAS-18J2KVRG-TR	RAS-18J2AVRG-TR		2,030	9,50	1,10
9.	RAS-B22J2KVRG-E	RAS-22J2AVRG-E		2,220	10,50	1,10
10.	RAS-22J2KVRG-TR	RAS-22J2AVRG-TR		2,220	10,50	1,10
11.	RAS-B24J2KVRG-E	RAS-24J2AVRG-E		2,670	12,80	1,14
12.	RAS-24J2KVRG-TR	RAS-24J2AVRG-TR		2,670	12,80	1,14
13.	RAS-24PKVSG-EE	RAS-24PAVSG-EE		2,670	12,80	1,14

Note: rated power supply 220-240V~ 50Hz

All models have the same construction, design and basic components used, except the marketing purpose as in table 24, Due to different of capacity,

The following models were tested at 220-240V~, 50 Hz and selected as representative sample for testing to represent all models in this report due to maximum capacity,

- Outdoor unit model RAS-B24J2KVRG-E matching with indoor unit model RAS-24J2AVRG-E was selected as representative samples for full test due to highest capacity,
- Outdoor unit model RAS-24PKVSG-EE matching with indoor unit model RAS-24PAVSG-EE was selected as representative samples 10, 11, 13, 19 due to indoor critical component and highest capacity,

Total Quality. Assured.

General product information (Cont'd):

- Outdoor unit model RAS-B10J2KVRG-E matching with indoor unit model RAS-10J2AVRG-E was selected as representative samples for test clause 10, 11, 13, 19 due to compressor used,
- Outdoor unit model RAS-B16J2KVRG-E matching with indoor unit model RAS-16J2AVRG-E was selected as representative samples for test clause 10, 11, 13 due to compressor used,
- Outdoor unit model RAS-B22J2KVRG-E matching with indoor unit model RAS-22J2AVRG-E was selected as representative samples for test clause 10, 11, 13 due to compressor used,

From the table below, select a refrigerant amount that is suitable for a piping length exceeding the length for which charging is actually needed,

Outdoor unit type	Length piping for which additional charging distance between	
	16m to 20 m	16m to 25 m
10 Class	0,61 kg	-
13 Class	0,77 kg	-
16 Class	0,90 kg	-
18/22 Class	1,20 kg	-
24 Class	-	1,34 kg

Additional information for safety test conditions:

- Appliances was tested at room temperature Indoor/outdoor (°C): 32/46 for cooling mode and 28/24 for heating mode of maximum condition cooling and heating,

IEC 60335-2-40			
Clause	Requirement + Test	Result - Remark	Verdict
5	GENERAL CONDITIONS FOR THE TESTS		--
	Tests performed according to clause 5, e.g. nature of supply, sequence of testing, etc.		P
5.2	Tests of clause 21 carried out on separate samples. Tests of clauses 11, 19 and 21 require pressure measurements made at various points in refrigerating system (IEC 60335-2-40:2018)		P
	At least one additional specially prepared sample required for tests of annex FF (Leak simulation tests) (IEC 60335-2-40:2018)		N/A
	Temperatures on refrigerant piping measured during test of clause 11 (IEC 60335-2-40:2018)		P
	If the tests of Annex LL are carried out, at least two additional sensors are needed. (IEC 60335-2-40:2018)		N/A
	If the test of Annex NN has to be carried out, an additional appliance may be used. (IEC 60335-2-40:2018)		N/A
	Due to the potentially hazardous nature of the tests of Clause 21 and Annexes EE and FF, special precautions need to be taken when carrying out the tests. (IEC 60335-2-40:2018)		N/A
5.6	Appropriate controls rendered inoperative during test (IEC 60335-2-40:2018)		P
5.7	Tests of clauses 10 and 11 carried out under most severe operating conditions within operating temperature range specified by manufacturer. Annex AA provide examples of such temperature conditions (IEC 60335-2-40:2018)		P
5.10	For split-package units, refrigerant lines installed in accordance with installation instructions (IEC 60335-2-40:2018)		P
	Length of pipe is between 5 m and 7,5 m. (IEC 60335-2-40:2018)		P
	Thermal insulation of refrigerant lines applied in accordance with installation instructions (IEC 60335-2-40:2018)		P
5.101	Motor-compressor subjected to relevant test of clause 19 of IEC 60335-2-34, unless (IEC 60335-2-40:2018)		P
	motor-compressor comply with that standard (IEC 60335-2-40:2018)		N/A
5.102	Motor-compressors tested and comply with IEC 60335-2-34 need not additionally tested for clause 21 (IEC 60335-2-40:2018)		N/A
6	CLASSIFICATION		--

IEC 60335-2-40			
Clause	Requirement + Test	Result - Remark	Verdict
6.1	Protection against electric shock: Class I, II, III (IEC 60335-2-40:2018)	Class I	P
6.2	Protection against harmful ingress of water, IP degree in accordance with IEC 60529 (IEC 60335-2-40:2018)		—
	- appliances or parts intended for outdoor use be at least IPX4 (IEC 60335-2-40:2018)	IPX4	P
	- appliances intended only for indoor use (excluding laundry rooms) be IPX0 (IEC 60335-2-40:2018)		N/A
	- appliances intended to be used in laundry rooms be at least IPX1 (IEC 60335-2-40:2018)		N/A
6.101	Degree of accessibility (accessible/not accessible to the general public) (IEC 60335-2-40:2018)	Accessible to the general public	P
7	MARKING AND INSTRUCTIONS		--
7.1	Rated voltage or voltage range (V)	220-240V~	P
	Symbol for nature of supply including number of phases, unless for single phase operation (IEC 60335-2-40:2018)	~	P
	Rated frequency (Hz)	50Hz	P
	Rated power input (W), or	See marking of outdoor unit	P
	Rated current (A)	See marking of outdoor unit	P
	Manufacturer's or responsible vendor's name, trademark or identification mark.....	TOSHIBA	P
	Model or type reference	See in general product information and marking	P
	Symbol IEC 60417-5172, for class II appliances		N/A
	IP number, other than IPX0.....	IPX4 for Outdoor unit	P
	Symbol IEC 60417-5180, for class III appliances, unless		N/A
	the appliance is operated by batteries only, or		N/A
	for appliances powered by rechargeable batteries recharged in the appliance		N/A
	Symbol IEC 60417-5018, for class II and class III appliances incorporating a functional earth		N/A
	Symbol IEC 60417-5036, for the enclosure of electrically-operated water valves in external hose-sets for connection of an appliance to the water mains, if the working voltage exceeds extra-low voltage		N/A
	Refrigerant charge for each refrigerating system (IEC 60335-2-40:2018)	See marking of outdoor unit	P
	Refrigerant number in accordance with ISO 817 (IEC 60335-2-40:2018)	R32	P

IEC 60335-2-40			
Clause	Requirement + Test	Result - Remark	Verdict
	Permissible excessive operating pressure for the storage tank (for sanitary hot water heat pumps); (IEC 60335-2-40:2018)		N/A
	Maximum allowable pressure in the water and/or brine circuit for the heat exchanger for hydronic fan coil units; (IEC 60335-2-40:2018)		N/A
	Maximum allowable pressure for the refrigerant circuit; if the permissible excessive operating pressure for the suction and discharge side differ, a separate indication is required; (IEC 60335-2-40:2018)	Pressure Low 2,26 MPa Pressure Hi 4,29 MPa See also outdoor marking label.	P
	for pre-charged pipe sets		—
	- refrigerant number in accordance with ISO 817 (IEC 60335-2-40:2018)		N/A
	- the refrigerant charge in the line set (IEC 60335-2-40:2018)		N/A
	- maximum allowable pressure (IEC 60335-2-40:2018)		N/A
	Ratings in watts and voltage of a UV-C germicidal lamp system if employed (IEC 60335-2-40:2018)		N/A
	Appliances are marked with all of the designations and the rated inputs of the supplementary heaters for which they are intended to be used, and have provision for identifying the actual heater that is field installed. (IEC 60335-2-40:2018)		N/A
	Marking of direction of fluid flow (IEC 60335-2-40:2018)	Evident form the design	N/A
	For appliances using flammable refrigerants, the flame symbol ISO 7010-W021 (2011-05) and the operator's manual symbol described in 7.6 be visible when viewing the appliance after it has been installed. (IEC 60335-2-40:2018)		P
	Marking may be behind a detachable part (IEC 60335-2-40:2018)		N/A
	Perpendicular height of the triangle used for the symbol shall be at least 30 mm. (IEC 60335-2-40:2018)		P
	For appliances that are not single packaged units, the required markings be provided on all indoor and outdoor units which complete the refrigerating system when installed. (IEC 60335-2-40:2018)		P
	When an A2L refrigerant is used, the flame symbol ISO 7010-W021 (2011-05) be replaced with the A2L symbol described in 7.6. (IEC 60335-2-40:2018)	The appliance using A2L refrigerant. However, the appliance mark with symbol ISO 7010-W021 which is considered covering A2L symbol.	P

IEC 60335-2-40			
Clause	Requirement + Test	Result - Remark	Verdict
	If a flammable refrigerant is used, the symbols for “read operator’s manual”, “operator’s manual; operating instructions” and “service indicator; read technical manual” (symbols ISO 7000-0790 (2004-01) and ISO 7000-1659 (2004-01)) including colour and format be placed on the appliance in a location visible to the persons required to know the information. The perpendicular height of the symbol be at least 10 mm. (IEC 60335-2-40:2018)		P
	If a flammable refrigerant is used, an additional warning symbol (flame symbol: ISO 7010-W021 (2011-05)) be placed on the nameplate of the unit near declaration of refrigerant type and charge information. Perpendicular height of the symbol be at least 10 mm, and symbol need not be in colour (IEC 60335-2-40:2018)		P
	When an A2L refrigerant is used, the flame symbol ISO 7010-W021 (2011-05) be replaced with the A2L symbol described in 7.6. (IEC 60335-2-40:2018)	The appliance using A2L refrigerant. However, the appliance mark with symbol ISO 7010-W021 which is considered covering A2L symbol.	P
	Following warning also be applied to the non-fixed appliance when a flammable refrigerant is employed. The warning be placed on the outside of the appliance such that it is visible when in service for non-fixed appliance. WARNING Appliance shall be installed, operated and stored in a room with a floor area larger than ‘X’ m ² . (IEC 60335-2-40:2018)	Fixed appliances	N/A
	Minimum room size X be specified on the appliance. The X in the marking be determined in m ² according to Annex GG; the marking not be required if the refrigerant charge (mc) of the appliance is up to m1 according to GG.1.2.		N/A
	If not already visible when accessing service port and if service port provided, service port marked to identify type of refrigerant. If refrigerant is flammable, symbol B.3.2 of ISO 3864, be included, without specifying the colour. When an A2L refrigerant is used, the flame symbol ISO 7010-W021 (2011-05) be replaced with the A2L symbol described in 7.6. (IEC 60335-2-40:2018)		P
	Appliances employing refrigerating systems with maximum allowable pressures > than 7 MPa be marked with symbol ISO 7000-1701 (2004-01) followed by the text “(X) MPa” and the Operator’s manual; operating instructions symbol ISO 7000-1641 (2004-01). (IEC 60335-2-40:2018)	Product Specified Max Pressure; 4.29MPa	N/A

IEC 60335-2-40			
Clause	Requirement + Test	Result - Remark	Verdict
	Where: "X" is not less than the maximum allowable pressure as determined in Annex EE. (IEC 60335-2-40:2018)		N/A
7.2	Warning for stationary appliances for multiple supply		N/A
	Warning placed in vicinity of terminal cover		N/A
7.3	Range of rated values marked with the lower and upper limits separated by a hyphen	220-240V	P
	Different rated values marked with the values separated by an oblique stroke		N/A
7.4	Appliances adjustable for different rated voltages or rated frequencies, the voltage or the frequency setting is clearly discernible		N/A
	Requirement met if frequent changes are not required and the rated voltage or rated frequency to which the appliance is to be adjusted is determined from a wiring diagram		N/A
7.5	Appliances with more than one rated voltage or one or more rated voltage ranges, marked with rated input or rated current for each rated voltage or range, unless		P
	the power input or current are related to the arithmetic mean value of the rated voltage range		P
	Relation between marking for upper and lower limits of rated power input or rated current and voltage is clear		N/A
7.6	Correct symbols used		P
	Symbol ISO 7010-W021 (2011-05) (IEC 60335-2-40:2018)		P
	Symbol ISO 7000-1659 (2004-01) (IEC 60335-2-40:2018)		P
	A2L symbol (IEC 60335-2-40:2018)		N/A
	Symbol ISO 7000-1701 (2004-01) (IEC 60335-2-40:2018)		N/A
	Symbol IEC 60417-6040 (2010-08) (IEC 60335-2-40:2018)		N/A
	Symbol ISO 7000-1641 (2004-01) (IEC 60335-2-40:2018)		P
	Symbol for nature of supply placed next to rated voltage	220-240V~	P
	Symbol for class II appliances placed unlikely to be confused with other marking	Class I appliance	N/A
	Units of physical quantities and their symbols according to international standardized system		P

IEC 60335-2-40			
Clause	Requirement + Test	Result - Remark	Verdict
7.7	Connection diagram fixed to appliances to be connected to more than two supply conductors and appliances for multiple supply, unless		N/A
	correct mode of connection is obvious		N/A
7.8	Except for type Z attachment, terminals for connection to the supply mains indicated as follows:		—
	- marking of terminals exclusively for the neutral conductor (letter N)		P
	- marking of protective earthing terminals (symbol IEC 60417-5019)		P
	- marking of functional earthing terminals (symbol IEC 60417-5018)		N/A
	- marking not placed on removable parts		P
7.9	Marking or placing of switches which may cause a hazard	Marking of Remote control	P
7.10	Indications of switches on stationary appliances and controls on all appliances by use of figures, letters or other visual means	Figure used on remote control	P
	This applies also to switches which are part of a control		P
	If figures are used, the off position indicated by the figure 0	START/STOP	N/A
	The figure 0 indicates only OFF position, unless no confusion with the OFF position		P
7.11	Indication for direction of adjustment of controls		P
7.12	Instructions for safe use provided		P
	Details concerning precautions during user maintenance		P
	Appliances not accessible to general public, classification of clause 6.101 included (IEC 60335-2-40:2018)	Accessible to general public	N/A
	Appliances using flammable refrigerants, an installation, service and operation manual, either separate or combined manuals, provided and include information given in annex DD (IEC 60335-2-40:2018)		P
	The instructions state that:		—
	- the appliance is not to be used by persons (including children) with reduced physical, sensory or mental capabilities, or lack of experience and knowledge, unless they have been given supervision or instruction		P
	- children being supervised not to play with the appliance		P

IEC 60335-2-40			
Clause	Requirement + Test	Result - Remark	Verdict
	For a part of class III construction supplied from a detachable power supply unit, the instructions state that the appliance is only to be used with the unit provided		N/A
	Instructions for class III appliances state that it must only be supplied at SELV, unless		N/A
	it is a battery-operated appliance, the battery being charged outside the appliance		N/A
	For appliances for altitudes exceeding 2000 m, the maximum altitude is stated.....:		N/A
	The instructions for appliances incorporating a functional earth states that the appliance incorporates an earth connection for functional purposes only		N/A
7.12.1	Sufficient details for installation supplied		P
	For an appliance intended to be permanently connected to the water mains and not connected by a hose-set, this is stated		N/A
	If different rated voltages or different rated frequencies are marked, the instructions state what action to be taken to adjust the appliance	220-240V, 50Hz	N/A
	Sufficient details for installation or maintenance supplied (IEC 60335-2-40:2018):		—
	- that the appliance shall be installed in accordance with national wiring regulations (IEC 60335-2-40:2018)		P
	- the dimensions of the space necessary for correct installation of the appliance including the minimum permissible distance to adjacent structures (IEC 60335-2-40:2018)		P
	- for appliances with supplementary heaters, the minimum clearance from the appliance to combustible surfaces (IEC 60335-2-40:2018)		N/A
	- a wiring diagram with a clear indication of the connections and wiring to external control devices and supply cord (IEC 60335-2-40:2018)		P
	- the range of external static pressures at which the appliance was tested (add-on heat pumps and appliances with supplementary heaters only) (IEC 60335-2-40:2018)		N/A
	- the method of connection to the appliance to the electrical supply and interconnection of separate components (IEC 60335-2-40:2018)		P
	- indication of which parts of the appliance are suitable for outdoor use, if applicable (IEC 60335-2-40:2018)		P

IEC 60335-2-40			
Clause	Requirement + Test	Result - Remark	Verdict
	- details of type and rating of fuses, or rating of circuit breakers; (IEC 60335-2-40:2018)	Breaker: 8,5A; 9,5A;11,5A; 12A ; 13,5A ; 16,0A See installation manual)	P
	- details of supplementary heating elements that may be used in conjunction with the appliance, including fitting instructions either with the appliance or with the supplementary heater (IEC 60335-2-40:2018)		N/A
	- maximum and minimum water or brine operating temperatures (IEC 60335-2-40:2018)		N/A
	- maximum and minimum water or brine operating pressures (IEC 60335-2-40:2018)		N/A
	- instructions on charging of refrigerants when addition of charge is required by the manufacturer for completing the refrigerating system. (IEC 60335-2-40:2018)		P
	Open storage tanks of heat pumps for water heating, accompanied by an instruction sheet which state that the vent shall not be obstructed (IEC 60335-2-40:2018)		N/A
7.12.2	Stationary appliances not fitted with means for disconnection from the supply mains having a contact separation in all poles that provide full disconnection under overvoltage category III, the instructions state that means for disconnection must be incorporated in the fixed wiring in accordance with the wiring rules		P
7.12.3	Insulation of the fixed wiring in contact with parts exceeding 50 K during clause 11; instructions state that the fixed wiring must be protected		N/A
7.12.4	Instructions for built-in appliances:		—
	- dimensions of space		N/A
	- dimensions and position of supporting and fixing		N/A
	- minimum distances between parts and surrounding structure		N/A
	- minimum dimensions of ventilating openings and arrangement		N/A
	- connection to supply mains and interconnection of separate components		N/A
	- allow disconnection of the appliance after installation, by accessible plug or a switch in the fixed wiring, unless		N/A
	a switch complying with 24.3		N/A
7.12.5	Replacement cord instructions, type X attachment with a specially prepared cord		N/A
	Replacement cord instructions, type Y attachment		P

IEC 60335-2-40			
Clause	Requirement + Test	Result - Remark	Verdict
	Replacement cord instructions, type Z attachment		N/A
7.12.6	Caution in the instructions for appliances incorporating a non-self-resetting thermal cut-out that is reset by disconnection of the supply mains, if this cut-out is required to comply with the standard		N/A
7.12.7	Instructions for fixed appliances stating how the appliance is to be fixed		P
7.12.8	Instructions for appliances connected to the water mains:		—
	- max. inlet water pressure (Pa)		N/A
	- min. inlet water pressure, if necessary (Pa).....		N/A
	Instructions concerning new and old hose-sets for appliances connected to the water mains by detachable hose-sets		N/A
7.12.9	Instructions specified in 7.12 and from 7.12.1 to 7.12.8 appear together before any other instructions supplied with the appliance		P
	These instructions may be supplied with the appliance separately from any functional use booklet		N/A
	They may follow the description of the appliance that identifies parts, or follow the drawings/sketches		N/A
	In addition, instructions are also available in an alternative format such as on a website or on request from the user in a format such as a DVD		N/A
	In addition, instructions are also available in an alternative format such as on a website or in a format such as a DVD	Website	P
7.13	Instructions and other texts in an official language	English	P
7.14	Markings clearly legible and durable:		—
	Signal words WARNING, CAUTION, DANGER in uppercase having a height as specified.....	4,0 mm.	P
	Uppercase letter of the text explaining the signal word not smaller than 1,6 mm.....	2,0 mm.	P
	Moulded in, engraved, or stamped markings either raised above or have a depth below the surface of at least 0,25 mm, unless		N/A
	contrasting colours are used		P
	Markings checked by inspection, measurement and rubbing test as specified		P
7.15	Markings on a main part		P
	Marking clearly discernible from the outside, if necessary after removal of a cover		P

IEC 60335-2-40			
Clause	Requirement + Test	Result - Remark	Verdict
	For portable appliances, cover can be removed or opened without a tool	Fixed appliance	N/A
	For stationary appliances, name, trademark or identification mark and model or type reference visible after installation		N/A
	For fixed appliances, name, trademark or identification mark and model or type reference visible after installation according to the instructions		P
	Indications for switches and controls placed on or near the components. Marking not on parts which can be positioned or repositioned in such a way that the marking is misleading		P
	The symbol IEC 60417-5018 placed next to the symbol IEC 60417-5172 or IEC 60417-5180		N/A
	Marking on panel allowed, provided panel in place for intended operation of appliance (IEC 60335-2-40:2018)		P
7.16	Marking of a possible replaceable thermal link or fuse link clearly visible with regard to replacing the link		N/A
7.101	Marking of fuses and overload protective devices, if replaceable (IEC 60335-2-40:2018):		—
	- fuse rated current in amperes, type and rated voltage or (IEC 60335-2-40:2018)		P
	- manufacturer and model of overload protective device (IEC 60335-2-40:2018)		P
7.102	Marking for connection with aluminium wire, if necessary (IEC 60335-2-40:2018)		N/A
7.103	For appliances made up of more than one factory made assembly specified by the manufacturer to be used together, instructions shall be provided for completing the assembly to ensure compliance with the requirements. (IEC 60335-2-40:2018)		N/A
7.104	For partial units, the instructions or markings shall include the following additional information: (IEC 60335-2-40:2018)		—
	- For evaporating units and condensing units, the instructions or markings shall include wording to assure that the maximum operating pressure is considered when connecting to any condenser unit or evaporator unit. (IEC 60335-2-40:2018)		N/A
	- For evaporating units, condensing units and condenser units, the instructions or markings shall include refrigerant charging instructions. (IEC 60335-2-40:2018)		N/A

IEC 60335-2-40			
Clause	Requirement + Test	Result - Remark	Verdict
	- A warning to assure that partial units shall only be connected to an appliance suitable for the same refrigerant. (IEC 60335-2-40:2018)		N/A
	- This unit <model xxx> is a partial unit air conditioner, complying with partial unit requirements of this International Standard, and must only be connected to other units that have been confirmed as complying to corresponding partial unit requirements of this International Standard. (IEC 60335-2-40:2018)		N/A
	- The electrical interfaces shall be specified with purpose, voltage, current, and safety class of construction. (IEC 60335-2-40:2018)		N/A
	- The SELV connection points, if provided, are to be clearly indicated in the instructions. The connection point should be marked with the “read the instructions” symbol per ISO 7000-0790 (2004-01) and the Class III symbol according to IEC 60417-5180 (2003- 02). (IEC 60335-2-40:2018)		N/A
7.105	For appliances using flammable refrigerants that have safety features depending upon the proper function of a refrigerant detecting system, the instructions or unit markings contain the substance of the following: (IEC 60335-2-40:2018)		—
	“This unit is equipped with a refrigerant leak detector for safety. To be effective, the unit must be electrically powered at all times after installation, other than when servicing.” (IEC 60335-2-40:2018)		N/A
	If any supplemental unit is employed to detect leaked refrigerant, such unit shall also apply this marking or be accompanied by such instructions. (IEC 60335-2-40:2018)		N/A
7.106	For appliances using flammable refrigerants that have safety features depending upon the proper function of ventilation, the instructions or unit markings shall contain the substance of the following: (IEC 60335-2-40:2018)		—
	“This unit is equipped with electrically powered safety measures. To be effective, the unit must be electrically powered at all times after installation, other than when servicing.” (IEC 60335-2-40:2018)		N/A
	If any supplemental unit is employed to dilute leaked refrigerant, such unit shall also apply this marking or be accompanied by such instructions. (IEC 60335-2-40:2018)		N/A

IEC 60335-2-40			
Clause	Requirement + Test	Result - Remark	Verdict
7.107	For flammable refrigerants, when addition of charge is required by the manufacturer installation instructions for completing the refrigerating system, the manufacturer provides a label that allows the installer to note the resulting total refrigerant charge for each refrigerating system. See Figure 101 for an example of label for field charged units. (IEC 60335-2-40:2018)		P
7.108	For appliances using flammable refrigerants, the flame symbol described in 7.6 be visible in each of the following conditions: (IEC 60335-2-40:2018)		—
	- on the packaging of the appliance if the appliance is charged with refrigerant excluding appliances with A2L refrigerant charge not exceeding m_1 ; (IEC 60335-2-40:2018)	A2L refrigerant charge not exceeding m_1 ; refrigerant charge: 1,34 kg; m_1 :1,84 kg	N/A
	- when viewing the appliance on display for sale. This does not apply to appliances using A2L refrigerants. (IEC 60335-2-40:2018)		N/A
	For appliances that are not factory sealed single packaged units, the required markings shall be provided on all indoor and outdoor units which complete the refrigerating system. (IEC 60335-2-40:2018)		N/A
7.109	Appliances employing UV-C germicidal lamp systems shall be marked with ultraviolet radiation hazard symbol IEC 60417-6040 (2010-08) and the Read operator's manual symbol ISO 7000-0790 (2004-01) in the following locations: (IEC 60335-2-40:2018)		—
	- doors and access panels that provide direct access to an area within the appliance where the measured UV-C spectral irradiance is greater than $1,7 \mu\text{W}/\text{cm}^2$; (IEC 60335-2-40:2018)		N/A
	- user maintenance access panels (IEC 60335-2-40:2018)		N/A
	- UV-C barriers. (IEC 60335-2-40:2018)		N/A
7.110	For appliances that employ UV-C germicidal lamp systems, the instructions include the substance of the following: (IEC 60335-2-40:2018)		—
	- this appliance contains a UV-C lamp; (IEC 60335-2-40:2018)		N/A
	- read the maintenance instructions before opening the appliance; (IEC 60335-2-40:2018)		N/A
	- details for cleaning and other user maintenance of the appliance. They shall state that prior to cleaning or other maintenance, the appliance must be disconnected from the supply mains;; (IEC 60335-2-40:2018)		N/A
	- precautions to be taken when replacing UV-C emitters and starters, if applicable; (IEC 60335-2-40:2018)		N/A

IEC 60335-2-40			
Clause	Requirement + Test	Result - Remark	Verdict
	- unintended use of the appliance or damage to the housing may result in the escape of dangerous UV-C radiation. UV-C radiation may, even in small doses, cause harm to the eyes and skin; (IEC 60335-2-40:2018)		N/A
	- the appliance must be disconnected from the supply before replacing the UV-C lamp; (IEC 60335-2-40:2018)		N/A
	- doors and access panels bearing the ultraviolet radiation hazard symbol which may have UV-C spectral irradiance greater than 1,7 $\mu\text{W}/\text{cm}^2$ are provided with an interlock switch to interrupt the power to the UV-C lamps for your safety. Do not over-ride; (IEC 60335-2-40:2018)		N/A
	- before opening doors and access panels bearing the ultraviolet radiation hazard symbol for the conducting user maintenance, it is recommended to disconnect the power; (IEC 60335-2-40:2018)		N/A
	- UV-C barriers bearing the ultraviolet radiation hazard symbol should not be removed; (IEC 60335-2-40:2018)		N/A
	- for appliances with UV-C lamps, information on the replacement of UV-C lamps shall be given, including the model and/or part number; (IEC 60335-2-40:2018)		N/A
	- if field installed, the factory specified UV-C germicidal lamp systems approved for use with the subject product shall be specified in the instructions by the specific model number; (IEC 60335-2-40:2018)		N/A
	- do not operate UV-C lamps outside of the appliance. (IEC 60335-2-40:2018)		N/A
7.111	For appliances employing refrigerating systems with maximum allowable pressures greater than 7 MPa, the instructions shall include the substance of the following: (IEC 60335-2-40:2018)		—
	- WARNING: System contains refrigerant under very high pressure. The system must be serviced by qualified persons only. (IEC 60335-2-40:2018)	Specified: Max pressure 4,29 MPa	N/A
8	PROTECTION AGAINST ACCESS TO LIVE PARTS		--
8.1	Adequate protection against accidental contact with live parts		P
8.1.1	Requirement applies for all positions, detachable parts removed		P
	Lamps behind a detachable cover not removed, if conditions met		N/A
	Insertion or removal of lamps, protection against contact with live parts of the lamp cap		N/A

IEC 60335-2-40			
Clause	Requirement + Test	Result - Remark	Verdict
	Use of test probe B of IEC 61032, with a force not exceeding 1 N: no contact with live parts		P
	Use of test probe B of IEC 61032 through openings, with a force of 20 N: no contact with live parts		P
8.1.2	Use of test probe 13 of IEC 61032, with a force not exceeding 1 N, through openings in class 0 appliances and class II appliances/constructions: no contact with live parts		P
	Test probe 13 also applied through openings in earthed metal enclosures having a non-conductive coating: no contact with live parts		P
8.1.3	For appliances other than class II, use of test probe 41 of IEC 61032, with a force not exceeding 1 N: no contact with live parts of visible glowing heating elements or supporting parts		N/A
	For a single switching action obtained by a switching device, requirements as specified		N/A
	For appliances with a supply cord and without a switching device, the single switching action may be obtained by the withdrawal of the plug		N/A
8.1.4	Accessible part not considered live if:		—
	- safety extra-low a.c. voltage: peak value not exceeding 42,4 V		N/A
	- safety extra-low d.c. voltage: not exceeding 42,4 V		N/A
	- or separated from live parts by protective impedance		N/A
	If protective impedance: d.c. current not exceeding 2 mA, and		N/A
	a.c. peak value not exceeding 0,7 mA		N/A
	- for peak values over 42,4 V up to and including 450 V, capacitance not exceeding 0,1 μ F		N/A
	- for peak values over 450 V up to and including 15 kV, discharge not exceeding 45 μ C		N/A
	- for peak values over 15 kV, the energy in the discharge not exceeding 350 mJ		N/A
8.1.5	Live parts protected at least by basic insulation before installation or assembly:		—
	- built-in appliances		N/A
	- fixed appliances		P
	- appliances delivered in separate units		P

IEC 60335-2-40			
Clause	Requirement + Test	Result - Remark	Verdict
	As regards the products which have a dedicated installation panel or cover and which cannot be installed without them, compliance is checked according to 5.10 (after the installation as instructed in the installation manual). (IEC 60335-2-40:2018)		P
8.2	Class II appliances and constructions constructed so that there is adequate protection against accidental contact with basic insulation and metal parts separated from live parts by basic insulation only		P
	Only possible to touch parts separated from live parts by double or reinforced insulation		P
9	STARTING OF MOTOR-OPERATED APPLIANCES		--
	Requirements and tests are specified in part 2 when necessary		N/A
10	POWER INPUT AND CURRENT		--
10.1	Power input at normal operating temperature, rated voltage and normal operation not deviating from rated power input by more than shown in table 1.....:	(see appended table)	P
	If the power input varies throughout the operating cycle and the maximum value of the power input exceeds, by a factor greater than two, the arithmetic mean value of the power input occurring during a representative period, the power input is the maximum value that is exceeded for more than 10 % of the representative period		N/A
	Otherwise the power input is the arithmetic mean value		N/A
	Test carried out at upper and lower limits of the ranges for appliances with one or more rated voltage ranges, unless		N/A
	the rated power input is related to the arithmetic mean value		P
10.2	Current at normal operating temperature, rated voltage and normal operation not deviating from rated current by more than shown in table 2.....:	(see appended table)	P
	If the current varies throughout the operating cycle and the maximum value of the current exceeds, by a factor greater than two, the arithmetic mean value of the current occurring during a representative period, the current is the maximum value that is exceeded for more than 10 % of the representative period		N/A
	Otherwise the current is the arithmetic mean value		N/A

IEC 60335-2-40			
Clause	Requirement + Test	Result - Remark	Verdict
	Test carried out at upper and lower limits of the ranges for appliances with one or more rated voltage ranges, unless		N/A
	the rated current is related to the arithmetic mean value of the range		P
11	HEATING		--
11.1	No excessive temperatures in normal use (IEC 60335-2-40:2018)		P
	Compliance is checked by the tests of annex C, if (IEC 60335-2-40:2018):		—
	- temperature of motor winding exceeds values shown in table 3 (IEC 60335-2-40:2018)		N/A
	- there is doubt about classification of insulation system of the motor (IEC 60335-2-40:2018)		N/A
11.2	Appliances are installed in a test room in accordance with the installation instructions. In particular, (IEC 60335-2-40:2018):		—
	- clearances to adjacent surfaces (IEC 60335-2-40:2018)		P
	- flow rates for liquid source or sink equipment be minimum, except for hydronic fan coil units where flow rates and liquid temperatures be maximum (IEC 60335-2-40:2018)		P
	- static pressures (IEC 60335-2-40:2018)		N/A
	- means of adjusting the flow, flow for tests be minimum obtainable (IEC 60335-2-40:2018)		N/A
	- adjustable limit controls set at maximum cut-out setting and minimum differential (IEC 60335-2-40:2018)		P
	Appliances with supplementary heaters, use test casing as described in 11.9 (IEC 60335-2-40:2018)		N/A
11.2.1	Appliances with supplementary heaters, inlet duct connected to inlet air opening (IEC 60335-2-40:2018)		N/A
	Appliance that includes or has provision for supplementary heater is fitted with a metal outlet duct in accordance with Figure 102a) or Figure 102b), depending on the direction of the airflow. (IEC 60335-2-40:2018)		N/A
	Inlet duct is provided with an adjustable restricting means by which the airflow can be reduced. (IEC 60335-2-40:2018)		N/A
	Restriction should be uniform across the duct's cross sectional area, so that the full heating coil surface will be exposed to the airflow except when the restriction is closed. (IEC 60335-2-40:2018)		N/A

IEC 60335-2-40			
Clause	Requirement + Test	Result - Remark	Verdict
11.2.2	Ducted appliance without supplementary heaters is fitted with an outlet duct sized to fit the casing flanges, or opening without flanges, or locations marked for flanges, and arranged to discharge away from the return air inlet. (IEC 60335-2-40:2018)		N/A
	Outlet duct is provided with a restricting means to obtain the maximum static pressure given in the instructions (IEC 60335-2-40:2018)		N/A
11.2.3	For the evaluation and testing of partial units, the following test setup and conditions are to be applied. (IEC 60335-2-40:2018)		N/A
	- evaporator units and condenser units are tested as individual units at the maximum ambient temperature stated in the instructions. If not stated in the instructions, these units shall be tested at an ambient temperature that is equal to the saturated temperature of the refrigerant at the marked maximum allowable operating pressure ($\pm 0,1$ MPa) minus 10 K (± 1 K). (IEC 60335-2-40:2018)		N/A
	- condensing units are tested in the cooling mode only, at the maximum specified ambient temperature with 9 K (± 1 K) sub-cooling and the maximum specified evaporating pressure with 11 K (± 1 K) superheat. For condensing units provided with expansion device(s), the superheat/sub-cooling is to be as under the normal control of the expansion device(s). (IEC 60335-2-40:2018)		N/A
	- evaporating units, intended for cooling only, are tested in the cooling mode only with a condensing pressure that is equal to the marked maximum allowable operating pressure ($\pm 0,1$ MPa) with 9 K (± 1 K) sub-cooling. (IEC 60335-2-40:2018)		N/A
	- evaporating units that are intended for reverse cycle operation are tested in the heating mode only, at the maximum specified evaporating pressure. (IEC 60335-2-40:2018)		N/A
11.3	Temperature rise determine by thermocouples or resistance method (IEC 60335-2-40:2018)	By both method	P
11.4	Test performed at supply voltage between 0,94 and 1,06 times the rated voltage (IEC 60335-2-40:2018)		P
	Heating elements energized at voltage which gives an electrical input of 1,15 times maximum rated power input (IEC 60335-2-40:2018)		N/A
11.5	Test conducted in heating mode and cooling mode, if both exist (IEC 60335-2-40:2018)		P

IEC 60335-2-40			
Clause	Requirement + Test	Result - Remark	Verdict
	All supplementary heating elements operative simultaneously (IEC 60335-2-40:2018)		N/A
11.6	Defrost test in most unfavourable conditions, if needed (IEC 60335-2-40:2018)		N/A
11.7	Appliances operated continuously until steady conditions except for defrost tests (IEC 60335-2-40:2018)		P
11.8	Temperatures not exceeding values of table 3 (IEC 60335-2-40:2018)	(See appended tables)	P
	Protective devices do not operate (IEC 60335-2-40:2018)		P
	Sealing compound not flowing out (IEC 60335-2-40:2018)		P
	Temperature of air in outlet duct not exceed 90 °C (IEC 60335-2-40:2018)		N/A
11.9	Test casing and installation of appliances in accordance with manufacturer's instructions (IEC 60335-2-40:2018)		N/A
	Glass fibre insulation for appliances without indication of minimum clearances according to manufacturer; thermocouple in contact with enclosure (IEC 60335-2-40:2018)		N/A
13	LEAKAGE CURRENT AND ELECTRIC STRENGTH AT OPERATING TEMPERATURE		—
13.1	Leakage current not excessive and electric strength adequate		P
	Heating appliances operated at 1,15 times the rated power input (W).....:		N/A
	Motor-operated appliances and combined appliances supplied at 1,06 times the rated voltage (V).....:	1,06 x 240V = 254,4V	P
	Protective impedance and radio interference filters disconnected before carrying out the tests		P
13.2	The leakage current is measured by means of the circuit described in figure 4 of IEC 60990:1999		P
	For stationary class I appliances, the leakage current shall not exceed 2 mA per kilowatt rated power input with a maximum value of 10 mA for appliances accessible to the general public, and a maximum value of 30 mA for appliances not accessible to the general public. (IEC 60335-2-40:2018)		P
	Leakage current measurements	(see appended table)	P
13.3	The appliance is disconnected from the supply		P
	Electric strength tests according to table 4	(see appended table)	P

IEC 60335-2-40			
Clause	Requirement + Test	Result - Remark	Verdict
	No breakdown during the tests		P
14	TRANSIENT OVERVOLTAGES		--
	Appliances withstand the transient over-voltages to which they may be subjected		N/A
	Clearances having a value less than specified in table 16 subjected to an impulse voltage test, the test voltage specified in table 6	(see appended table)	N/A
	No flashover during the test, unless		N/A
	of functional insulation if the appliance complies with clause 19 with the clearance short-circuited		N/A
15	MOISTURE RESISTANCE		--
15.1	Enclosure provides degree of moisture protection against ingress of water (rain, overflow from drain pan or defrosting), tests of clause 15.2, 15.3, 11.6 and 16) (IEC 60335-2-40:2018)		P
	Motor-compressor not operated and detachable parts removed during tests of clause 15.2 and 15.3 (IEC 60335-2-40:2018)		P
15.2	Tests in accordance with IEC 60529 in appliances other than IPX0, as specified (IEC 60335-2-40:2018)	IPX4 for outdoor unit	P
15.3	Drain pan filled to brim and subjected to continuous overflow and fan(s) switched on (IEC 60335-2-40:2018)		P
15.101	Spillage test as specified (IEC 60335-2-40:2018)	After installed as recommend in installation manual, unit whose top has a height greater than 2,5 m	N/A
	After spillage completed, appliance withstand test of clause 16 (IEC 60335-2-40:2018)		N/A
16	LEAKAGE CURRENT AND ELECTRIC STRENGTH		--
16.1	Leakage current not excessive and electric strength adequate		P
	Protective impedance disconnected from live parts before carrying out the tests		P
	Tests carried out at room temperature and not connected to the supply		P
16.2	Single-phase appliances: test voltage 1,06 times rated voltage (V).....	1,06x240V = 254,4V	P
	Three-phase appliances: test voltage 1,06 times rated voltage divided by $\sqrt{3}$ (V)		N/A
	Leakage current measurements (IEC 60335-2-40:2018)	(see appended table)	P

IEC 60335-2-40			
Clause	Requirement + Test	Result - Remark	Verdict
	Limit values doubled if:		—
	- all controls have an off position in all poles, or		N/A
	- the appliance has no control other than a thermal cut-out, or		N/A
	- all thermostats, temperature limiters and energy regulators do not have an off position, or		N/A
	- the appliance has radio interference filters		N/A
	With the radio interference filters disconnected, the leakage current do not exceed limits specified	(see appended table)	N/A
16.3	Electric strength tests according to table 7	(see appended table)	P
	Test voltage applied between the supply cord and inlet bushing and cord guard and cord anchorage as specified	(see appended table)	N/A
	No breakdown during the tests		P
17	OVERLOAD PROTECTION OF TRANSFORMERS AND ASSOCIATED CIRCUITS		--
	No excessive temperatures in transformer or associated circuits in event of short-circuits likely to occur in normal use.....	(see appended table)	N/A
	Appliance supplied with 1,06 or 0,94 times rated voltage under the most unfavourable short-circuit or overload likely to occur in normal use (V).....		N/A
	Basic insulation is not short-circuited		N/A
	Temperature rise of insulation of the conductors of safety extra-low voltage circuits not exceeding the relevant value specified in table 3 by more than 15 K		N/A
	Temperature of the winding not exceeding the value specified in table 8		N/A
	However, limits do not apply to fail-safe transformers complying with sub-clause 15.5 of IEC 61558-1		N/A
18	ENDURANCE		--
	Requirements and tests are specified in part 2 when necessary		N/A
19	ABNORMAL OPERATION		--
19.1	The risk of fire, mechanical damage or electric shock under abnormal or careless operation obviated		P
	Electronic circuits so designed and applied that a fault will not render the appliance unsafe	(see appended table)	P

IEC 60335-2-40			
Clause	Requirement + Test	Result - Remark	Verdict
	Failure of transfer medium flow, or of any control device, does not result in a hazard (IEC 60335-2-40:2018)		P
	Appliances are subjected to the tests specified in 19.2 to 19.10, 19.101, 19.102 and 19.103, as applicable. (IEC 60335-2-40:2018)		P
	Appliances incorporating electronic circuits subjected to the tests of 19.11 and 19.12, as applicable		P
	Appliances incorporating contactors or relays subjected to the test of 19.14, being carried out before the tests of 19.11		P
	Appliances incorporating voltage selector switches subjected to the test of 19.15		N/A
	Unless otherwise specified, the tests are continued until a non-self-resetting thermal cut-out operates, or		N/A
	until steady conditions are established		P
	If a heating element or intentionally weak part becomes open-circuited, the relevant test is repeated on a second sample		N/A
19.2	Test of appliances with supplementary heaters (IEC 60335-2-40:2018)		N/A
19.3	Test of appliance with any defect which expected during normal use (IEC 60335-2-40:2018)		P
19.4	Test of 19.4 repeated on class 0I and I appliances with tubular sheathed or embedded heating elements. No short-circuiting, but one end of the element connected to the sheath		N/A
	The test repeated with reversed polarity and the other end of the heating element connected to the sheath		N/A
19.5	The test is not carried out on appliances intended to be permanently connected to fixed wiring and on appliances where an all-pole disconnection occurs during the test of 19.4		N/A
	Appliances with PTC heating elements tested at rated voltage, establishing steady conditions		N/A
	The working voltage of the PTC heating element is increased by 5 % and the appliance is operated until steady conditions are re-established. The voltage is then increased in similar steps until 1,5 times working voltage or until the PTC heating element ruptures (V)		N/A

IEC 60335-2-40			
Clause	Requirement + Test	Result - Remark	Verdict
19.6	Test of appliance with motor rotors, other than motor-compressors and stationary circulation pumps in compliance with IEC 60335-2-51, operated for 15 days (360 h) or until protection device opens circuit (IEC 60335-2-40:2018)		P
	Test of appliance with any defect which expected during normal use (IEC 60335-2-40:2018)		P
19.7	Test of 19.4 repeated on class 0I and I appliances with tubular sheathed or embedded heating elements. No short-circuiting, but one end of the element connected to the sheath		N/A
	Insulation of motor windings (IEC 60335-2-40:2018)	Class E	P
	Temperature of enclosure does not exceed (°C) (IEC 60335-2-40:2018)	(See appended table)	P
	Temperature of the windings does not exceed the values shown in the table 8; temperature (°C) (IEC 60335-2-40:2018)	Class E (See appended table)	P
	Electric strength test as specified in 16.3, 72 h after the beginning of the test (IEC 60335-2-40:2018)		P
	At the end, leakage current between windings and enclosure does not exceed 2 mA (IEC 60335-2-40:2018)		P
	Winding temperatures not exceeding values specified in table 8	(see appended table)	P
	If the motor-compressor has not been type-tested against the requirements of IEC 60335-2-34, a sample is provided with the rotor locked and being filled with oil and refrigerant as intended. (IEC 60335-2-40:2018)		P
	Sample is subjected to the tests specified in 19.101, 19.102, 19.103 and 19.105 of IEC 60335-2-34:2012, if applicable, and complies with the requirements in 19.104 of IEC 60335-2-34:2012. (IEC 60335-2-40:2018)		P
19.8	Three phase motors other than motor compressors are operated under the conditions of Clause 11 at rated voltage or at the upper limit of the rated voltage range with one phase disconnected, until steady conditions are obtained or the protective device operates. (IEC 60335-2-40:2018)		P
19.10	Series motor operated at 1,3 times rated voltage for 1 min (V).....		N/A
	During the test, parts not being ejected from the appliance		N/A

IEC 60335-2-40			
Clause	Requirement + Test	Result - Remark	Verdict
19.11	Electronic circuits, compliance checked by evaluation of the fault conditions specified in 19.11.2 for all circuits or parts of circuits, unless		P
	they comply with the conditions specified in 19.11.1		P
	Appliances incorporating an electronic circuit that relies upon a programmable component to function correctly, subjected to the test of 19.11.4.8, unless		N/A
	restarting does not result in a hazard		N/A
	Appliances having a device with an off position obtained by electronic disconnection, or a device placing the appliance in a stand-by mode, subjected to the tests of 19.11.4		N/A
	If the safety of the appliance under any of the fault conditions depends on the operation of a miniature fuse-link complying with IEC 60127, the test of 19.12 is carried out		P
	During and after each test the following is checked:		—
	- the temperature of the windings do not exceed the values specified in table 8		P
	- the appliance complies with the conditions specified in 19.13		P
	- any current flowing through protective impedance not exceeding the limits specified in 8.1.4		N/A
	If a conductor of a printed board becomes open-circuited, the appliance is considered to have withstood the particular test, provided both of the following conditions are met:		—
	- the base material of the printed circuit board withstands the test of annex E		N/A
	- any loosened conductor does not reduce clearance or creepage distances between live parts and accessible metal parts below the values specified in clause 29		N/A
19.11.1	Fault conditions a) to g) in 19.11.2 are not applied to circuits or parts of circuits meeting both of the following conditions:		—
	- the electronic circuit is a low-power circuit, that is, the maximum power at low-power points does not exceed 15 W according to the tests specified		P
	- the protection against electric shock, fire hazard, mechanical hazard or dangerous malfunction of other parts of the appliance does not rely on the correct functioning of the electronic circuit		P
19.11.2	Fault conditions applied one at a time, the appliance operating under conditions specified in clause 11, but supplied at rated voltage, duration of the tests as specified:		—

IEC 60335-2-40			
Clause	Requirement + Test	Result - Remark	Verdict
	a) short circuit of functional insulation if clearances or creepage distances are less than the values specified in clause 29		N/A
	b) open circuit at the terminals of any component		P
	c) short circuit of capacitors, unless		P
	they comply with IEC 60384-14		P
	d) short circuit of any two terminals of an electronic component, other than integrated circuits		P
	This fault condition is not applied between the two circuits of an optocoupler		P
	e) failure of triacs in the diode mode		N/A
	f) failure of microprocessors and integrated circuits		P
	g) failure of an electronic power switching device		P
	Each low power circuit is short-circuited by connecting the low-power point to the pole of the supply source from which the measurements were made		P
19.11.3	If the appliance incorporates a protective electronic circuit that operates to ensure compliance with clause 19, the appliance is tested as specified		N/A
19.11.4	The first paragraph of Part 1 in not applicable for stand-by mode if unintentional operation does not cause any hazards. (IEC 60335-2-40:2018)		P
	Appliances having a device with an off position obtained by electronic disconnection, or		N/A
	a device that can be placed in the stand-by mode,		N/A
	subjected to the tests of 19.11.4.1 to 19.11.4.7, the device being set in the off position or in the stand-by mode		N/A
	Appliances incorporating a protective electronic circuit are subjected to the tests of 19.11.4.1 to 19.11.4.7. (IEC 60335-2-40:2018)		P
	Tests are carried out after the protective electronic circuit has operated during the relevant tests of Clause 19 except 19.2, 19.6, 19.11.3, 19.102 and 19.103. (IEC 60335-2-40:2018)		P
	If the appliance incorporates more than one protective electronic circuit, each protective electronic circuit has to be tested individually with the appliance operated under normal operation at any temperature within the working range. (IEC 60335-2-40:2018)		P

IEC 60335-2-40			
Clause	Requirement + Test	Result - Remark	Verdict
	Components protected by a protective electronic, if engineering judgement gives evidence that the test in the final application will not lead to a hazardous condition. (IEC 60335-2-40:2018)		P
	Surge protective devices disconnected, unless		P
	They incorporate spark gaps		N/A
	For these tests, it may be necessary to provide specially prepared component samples, e.g. compressors with locked rotor. (IEC 60335-2-40:2018)		P
19.11.4.1	The appliance is subjected to electrostatic discharges in accordance with IEC 61000-4-2, test level 4		P
19.11.4.2	The appliance is subjected to radiated fields in accordance with IEC 61000-4-3, at frequency ranges specified		P
19.11.4.3	The appliance is subjected to fast transient bursts in accordance with IEC 61000-4-4, test level 3 or 4 as specified		P
19.11.4.4	The power supply terminals of the appliance subjected to voltage surges in accordance with IEC 61000-4-5, test level 3 or 4 as specified		P
	An open circuit test voltage of 2 kV is applicable for the line-to-line coupling mode		P
	An open circuit test voltage of 4 kV is applicable for the line-to-earth coupling		P
	Earthed heating elements in class I appliances disconnected		N/A
19.11.4.5	The appliance is subjected to injected currents in accordance with IEC 61000-4-6, test level 3		P
19.11.4.6	Appliances having a rated current not exceeding 16 A are subjected to the class 3 voltage dips and interruptions in accordance with IEC 61000-4-11		P
	Appliances having a rated current exceeding 16 A are subjected to the class 3 voltage dips and interruptions in accordance with IEC 61000-4-34		N/A
19.11.4.7	The appliance is subjected to mains signals in accordance with IEC 61000-4-13, test level class 2		P
19.11.4.8	The appliance is supplied at rated voltage and operated under normal operation at any temperature within the working range. After 60 s the power supply is reduced to a level such that the appliance ceases to respond or parts controlled by the programmable component cease to operate. (IEC 60335-2-40:2018)		P

IEC 60335-2-40			
Clause	Requirement + Test	Result - Remark	Verdict
	The appliance continues to operate normally, or		N/A
	requires a manual operation to restart		P
19.12	If the safety of the appliance for any of the fault conditions specified in 19.11.2 depends on the operation of a miniature fuse-link complying with IEC 60127, the test is repeated, measuring the current flowing through the fuse-link; measured current (A); rated current of the fuse-link (A)	Measure : $\geq 19A$; Rated current of fuse 6,3A Measure : $\geq 10A$; Rated current of fuse 3,15A Measure : $\geq 3A$; Rated current of fuse 1,0A	P
19.13	During the tests the appliance does not emit flames, molten metal, poisonous or ignitable gas in hazardous amounts		P
	Temperature rises not exceeding the values shown in table 9	(see appended table)	P
	Compliance with clause 8 not impaired		P
	If the appliance can still be operated it complies with 20.2		P
	Insulation, other than of class III appliances or class III constructions that do not contain live parts, withstands the electric strength test of 16.3, the test voltage as specified in table 4:		—
	- basic insulation (V)	1000V	P
	- supplementary insulation (V)	1750V	P
	- reinforced insulation (V)	3000V	P
	After operation or interruption of a control, clearances and creepage distances across the functional insulation withstand the electric strength test of 16.3, the test voltage being twice the working voltage		P
	The appliance does not undergo a dangerous malfunction, and		P
	no failure of protective electronic circuits, if the appliance is still operable		P
	Appliances tested with an electronic switch in the off position, or in the stand-by mode:		—
	- do not become operational, or		N/A
	- if they become operational, do not result in a dangerous malfunction during or after the tests of 19.11.4		P
	If the appliance contains lids or doors that are controlled by one or more interlocks, one of the interlocks may be released provided that:		—
	- the lid or door does not move automatically to an open position when the interlock is released, and		N/A
	- the appliance does not start after the cycle in which the interlock was released		N/A

IEC 60335-2-40			
Clause	Requirement + Test	Result - Remark	Verdict
19.14	Appliances operated under the conditions of clause 11, any contactor or relay contact operating under the conditions of clause 11 being short-circuited		P
	For a relay or contactor with more than one contact, all contacts are short-circuited at the same time		P
	A relay or contactor operating only to ensure the appliance is energized for normal use is not short-circuited		P
	If more than one relay or contactor operates in clause 11, they are short-circuited in turn		P
	Locking in the "on" position of the main contacts of a contact intended for switching on and off the heating element(s) in normal use is considered to be a fault condition, unless the appliance is provided with at least two sets of contacts connected in series. (IEC 60335-2-40:2018)		N/A
	This condition is, for example, achieved by providing two contactors operating independently of each other or by providing one contactor having two independent armatures operating two independent sets of main contacts. (IEC 60335-2-40:2018)		N/A
19.15	For appliances with a mains voltage selector switch, the switch is set to the lowest rated voltage position and the highest value of rated voltage is applied		N/A
19.101	Test of appliance with heat transfer medium flow of the outdoor heat exchanger restricted or shut off when reaching steady conditions (IEC 60335-2-40:2018)		P
	Test of appliance with heat transfer flow of the indoor heat exchanger restricted or shut off when reaching steady conditions (IEC 60335-2-40:2018)		P
	Disconnection of motor common to both the outdoor and the indoor heat exchangers when reaching steady conditions (IEC 60335-2-40:2018)		N/A
19.102	Test of appliances using water as heat transfer medium (IEC 60335-2-40:2018)		N/A
19.103	Test of air to air appliances at rated voltage or at the upper limit of the rated voltage range. Dry-bulb temperature is 5 K below values specified by manufacturer (IEC 60335-2-40:2018)		P
	Test with the dry-bulb temperature 10 K over the values specified by manufacturer (IEC 60335-2-40:2018)		P

IEC 60335-2-40			
Clause	Requirement + Test	Result - Remark	Verdict
19.104	All appliances provided with supplementary heaters and free air discharge subjected to specified test in each mode of operation (IEC 60335-2-40:2018)		N/A
	During test temperature not exceed 150 °C but an overshoot of 25 °C is permitted during first hour (IEC 60335-2-40:2018)		N/A
	Thermal protective devices are allowed to operate. (IEC 60335-2-40:2018)		N/A
20	STABILITY AND MECHANICAL HAZARDS		--
20.1	Appliances having adequate stability		N/A
	Tilting test through an angle of 10°, appliance placed on an inclined plane/horizontal support, not connected to the supply mains; appliance does not overturn		N/A
	Tilting test repeated on appliances with heating elements, angle of inclination increased to 15°		N/A
	Possible heating test in overturned position; temperature rise does not exceed values shown in table 9		N/A
20.2	Moving parts adequately arranged or enclosed as to provide protection against personal injury		P
	Protective enclosures, guards and similar parts are non-detachable, and		P
	have adequate mechanical strength		P
	Enclosures that can be opened by overriding an interlock are considered to be detachable parts		N/A
	Self-resetting thermal cut-outs and overcurrent protective devices not causing a hazard by unexpected closure		P
	Not possible to touch dangerous moving parts with the test probe described		P
21	MECHANICAL STRENGTH		--
21.1	Appliance has adequate mechanical strength and is constructed as to withstand rough handling		P
	Checked by applying 3 blows to every point of the enclosure like to be weak, in accordance with test Ehb of IEC 60068-2-75, spring hammer test, with an impact energy of 0,5 J	(see appended table)	P
	The appliance shows no damage impairing compliance with this standard, and		P
	compliance with 8.1, 15.1 and clause 29 not impaired		P

IEC 60335-2-40			
Clause	Requirement + Test	Result - Remark	Verdict
	If doubt, supplementary or reinforced insulation subjected to the electric strength test of 16.3		N/A
	If necessary, repetition of groups of three blows on a new sample		N/A
	Safety requirements specified in annex EE apply. Pressure test in annex EE applies to parts other than pressure vessels (IEC 60335-2-40:2018)		P
	Safety requirements of ISO 14903 apply (IEC 60335-2-40:2018)		P
21.2	Accessible parts of solid insulation having strength to prevent penetration by sharp implements		P
	Test not applicable if the thickness of supplementary insulation is at least 1 mm and reinforced insulation at least 2 mm		P
	The insulation is tested as specified, and does withstand the electric strength test of 16.3		N/A
	Appliances using flammable refrigerants withstand the effects of vibration during transport. (IEC 60335-2-40:2018)		P
	Appliance is tested in its final packaging for transport and withstands a random vibration test according to ASTM D4728-06. Tests be run for a duration of 180 min. (IEC 60335-2-40:2018)		P
	Compliance is checked as specified (IEC 60335-2-40:2018)		P
22	CONSTRUCTION		--
22.1	Appliance marked with the first numeral of the IP system, relevant requirements of IEC 60529 are fulfilled	IPX4	N/A
22.2	Stationary appliance: means to ensure all-pole disconnection from the supply being provided:		—
	- a supply cord fitted with a plug, or		N/A
	- a switch complying with 24.3, or		N/A
	- a statement in the instruction sheet that a disconnection incorporated in the fixed wiring is to be provided, or		P
	- an appliance inlet		N/A
	Single-pole switches and single-pole protective devices for the disconnection of heating elements in single-phase, permanently connected class 01 and class I appliances, connected to the phase conductor		N/A
22.3	Appliance provided with pins: no undue strain on socket-outlets		N/A

IEC 60335-2-40			
Clause	Requirement + Test	Result - Remark	Verdict
	Applied torque not exceeding 0,25 Nm		N/A
	Pull force of 50 N to each pin after the appliance has being placed in the heating cabinet; when cooled to room temperature the pins are not displaced by more than 1 mm		N/A
	Each pin subjected to a torque of 0,4 Nm; the pins are not rotating, unless		N/A
	rotating does not impair compliance with this standard		N/A
22.4	Appliance for heating liquids and appliance causing undue vibration not provided with pins for insertion into socket-outlets		N/A
22.5	No risk of electric shock when touching pins, for appliances having a capacitor with rated capacitance equal to or greater than 0,1 µF, the appliance being disconnected from the supply at the instant of voltage peak		N/A
	Voltage not exceeding 34 V (V)		N/A
	If compliance relies on the operation of an electronic circuit, the electromagnetic phenomena tests of 19.11.4.3 and 19.11.4.4 are applied		N/A
	The discharge test is then repeated three times, voltage not exceeding 34 V (V).....		N/A
22.6	Electrical insulation not affected by condensing water or leaking liquid		P
	Electrical insulation of class II appliances not affected if a hose ruptures or seal leaks		N/A
	In case of doubt, test as described		N/A
	Electrical insulation not affected by snow penetration to appliance enclosure (IEC 60335-2-40:2018)		P
22.7	Adequate safeguards against the risk of excessive pressure in appliances containing liquid or gases or having steam-producing devices		N/A
22.8	Electrical connections not subject to pulling during cleaning of compartments to which access can be gained without the aid of a tool, and that are likely to be cleaned in normal use		P
22.9	Insulation, internal wiring, windings, commutators and slip rings not exposed to oil, grease or similar substances, unless		P
	the substance has adequate insulating properties		N/A
22.10	Not possible to reset voltage-maintained non-self-resetting thermal cut-outs by the operation of an automatic switching device incorporated within the appliance, if:		N/A

IEC 60335-2-40			
Clause	Requirement + Test	Result - Remark	Verdict
	- a non-self-resetting thermal cut-out is required by the standard, and		N/A
	- a voltage maintained non-self-resetting thermal cut-out is used to meet it		N/A
	Non-self-resetting thermal motor protectors have a trip-free action, unless		N/A
	they are voltage maintained		N/A
	Reset buttons of non-self-resetting controls so located or protected that accidental resetting is unlikely		N/A
22.11	Reliable fixing of non-detachable parts that provide the necessary degree of protection against electric shock, moisture or contact with moving parts		P
	Obvious locked position of snap-in devices used for fixing such parts		N/A
	No deterioration of the fixing properties of snap-in devices used in parts that are likely to be removed during installation or servicing		N/A
	Tests as described		P
22.12	Handles, knobs etc. fixed in a reliable manner, if loosening result in a hazard		N/A
	Removing or fixing in wrong position of handles, knobs etc. indicating position of switches or similar components not possible, if resulting in a hazard		N/A
	A choking hazard does not apply to appliances for commercial use		N/A
	Axial force 15 N applied to parts, the shape being so that an axial pull is unlikely to be applied		N/A
	Axial force 30 N applied to parts, the shape being so that an axial pull is likely to be applied		N/A
	If the part is removed and can be contained within the small parts cylinder, it is considered to be a choking hazard		N/A
22.13	Unlikely that handles, when gripped as in normal use, make the operator's hand touch parts having a temperature rise exceeding the value specified for handles which are held for short periods only		N/A
22.14	No ragged or sharp edges creating a hazard for the user in normal use, or during user maintenance		P
	No exposed pointed ends of self-tapping screws or other fasteners, likely to be touched by the user in normal use or during user maintenance		P
	This requirement does not apply to the metallic fins of heat exchangers. (IEC 60335-2-40:2018)		P

IEC 60335-2-40			
Clause	Requirement + Test	Result - Remark	Verdict
22.15	Storage hooks and the like for flexible cords smooth and well rounded		N/A
22.16	Automatic cord reels cause no undue abrasion or damage to the sheath of the flexible cord, no breakage of conductors strands and no undue wear of contacts		N/A
	Cord reel tested with 6000 operations, as specified		N/A
	Electric strength test of 16.3, voltage of 1000 V applied		N/A
22.17	Spacers not removable from the outside by hand or by means of a screwdriver or a spanner		N/A
22.18	Current-carrying parts and other metal parts resistant to corrosion		P
22.19	Driving belts not relied upon to provide the required level of insulation, unless		N/A
	constructed to prevent inappropriate replacement		N/A
22.20	Direct contact between live parts and thermal insulation effectively prevented, unless		N/A
	material used is non-corrosive, non-hygroscopic and non-combustible		N/A
22.21	Wood, cotton, silk, ordinary paper and fibrous or hygroscopic material not used as insulation, unless		P
	impregnated		N/A
	This requirement does not apply to magnesium oxide and mineral ceramic fibres used for the electrical insulation of heating elements		N/A
22.22	Appliances not containing asbestos		P
22.23	Oils containing polychlorinated biphenyl (PCB) not used		P
22.24	Bare heating elements adequately supported to prevent contact with accessible metal parts nor give rise to a hazard in case of rupture or sagging (IEC 60335-2-40:2018)		N/A
	Bare heating elements not used with wood or wood composite enclosures. (IEC 60335-2-40:2018)		N/A
22.25	Sagging heating conductors, except in class III appliances or class III constructions that do not contain live parts, cannot come into contact with accessible metal parts		N/A
22.26	For class III constructions the insulation between parts operating at safety extra-low voltage and other live parts complies with the requirements for double or reinforced insulation		N/A
22.27	Parts connected by protective impedance separated by double or reinforced insulation		N/A

IEC 60335-2-40			
Clause	Requirement + Test	Result - Remark	Verdict
22.28	Metal parts of class II appliances conductively connected to gas pipes or in contact with water, separated from live parts by double or reinforced insulation		N/A
22.29	Class II appliances permanently connected to fixed wiring so constructed that the required degree of access to live parts is maintained after installation		P
22.30	Parts serving as supplementary or reinforced insulation fixed so that they cannot be removed without being seriously damaged, or		N/A
	so constructed that they cannot be replaced in an incorrect position, and so that if they are omitted, the appliance is rendered inoperable or manifestly incomplete		P
22.31	Neither clearances nor creepage distances over supplementary and reinforced insulation reduced below values specified in clause 29 as a result of wear		P
	Neither clearances nor creepage distances between live parts and accessible parts reduced below values for supplementary insulation if wires, screws etc. become loose		P
22.32	Supplementary and reinforced insulation constructed or protected against pollution so that clearances or creepage distances are not reduced below the values in clause 29		P
	Supplementary insulation of natural or synthetic rubber resistant to ageing, or arranged and dimensioned so that creepage distances are not reduced below values specified in 29.2		N/A
	Ceramic material not tightly sintered, similar materials or beads alone not used as supplementary or reinforced insulation		N/A
	Ceramic and similar porous material in which heating conductors are embedded is considered to be basic insulation, not reinforced insulation		N/A
	Oxygen bomb test at 70 °C for 96 h and 16 h at room temperature		N/A
22.33	Conductive liquids that are or may become accessible in normal use and conductive liquids that are in contact with unearthed accessible metal parts are not in direct contact with live parts, or		P
	unearthed metal parts separated from live parts by basic insulation only		P
	Electrodes not used for heating liquids		N/A

IEC 60335-2-40			
Clause	Requirement + Test	Result - Remark	Verdict
	For class II constructions, conductive liquids that are or may become accessible in normal use and conductive liquids that are in contact with unearthed accessible metal parts, not in direct contact with basic or reinforced insulation, unless		P
	the reinforced insulation consists of at least 3 layers		N/A
	For class II constructions, conductive liquids which are in contact with live parts, not in direct contact with reinforced insulation, unless		P
	the reinforced insulation consists of at least 3 layers		N/A
	An air layer not used as basic or supplementary insulation in a double insulation system if likely to be bridged by leaking liquid		P
22.34	Shafts of operating knobs, handles, levers etc. not live, unless		N/A
	the shaft is not accessible when the part is removed		N/A
22.35	For other than class III constructions, handles, levers and knobs, held or actuated in normal use, not becoming live in the event of a failure of basic insulation		N/A
	Such parts being of metal, and their shafts or fixings are likely to become live in the event of a failure of basic insulation, are either adequately covered by insulation material or their accessible parts are separated from their shafts or fixings by supplementary insulation		N/A
	This requirement does not apply to handles, levers and knobs on stationary appliances and cordless appliances, other than those of electrical components, provided they are reliably connected to an earthing terminal or earthing contact, or separated from live parts by earthed metal		N/A
	Insulating material covering metal handles, levers and knobs withstand the electric strength test of 16.3 for supplementary insulation		N/A
22.36	For appliances other than class III, handles continuously held in the hand in normal use so constructed that when gripped as in normal use, the operators hand is not likely to touch metal parts, unless		N/A
	they are separated from live parts by double or reinforced insulation		N/A
22.37	Capacitors in class II appliances not connected to accessible metal parts and their casings, if of metal, separated from accessible metal parts by supplementary insulation, unless		N/A

IEC 60335-2-40			
Clause	Requirement + Test	Result - Remark	Verdict
	the capacitors comply with 22.42		N/A
22.38	Capacitors not connected between the contacts of a thermal cut-out		P
22.39	Lamp holders used only for the connection of lamps		N/A
22.40	Motor-operated appliances and combined appliances intended to be moved while in operation, or having accessible moving parts, fitted with a switch to control the motor. The actuating member of the switch being easily visible and accessible		N/A
	If the appliance cannot operate continuously, automatically or remotely without giving rise to a hazard, appliances for remote operation being fitted with a switch for stopping the operation. The actuating member of the switch being easily visible and accessible		N/A
22.41	No components, other than lamps, containing mercury		P
22.42	Protective impedance consisting of at least two separate components		N/A
	Values specified in 8.1.4 not exceeded if any one of the components are short-circuited or open-circuited		N/A
	Resistors checked by the test of 14.1 a) in IEC 60065		N/A
	Capacitors checked by the tests for class Y capacitors in IEC 60384-14		N/A
22.43	Appliances adjustable for different voltages, accidental changing of the setting of the voltage unlikely to occur		N/A
22.44	Appliances not having an enclosure that is shaped or decorated like a toy		P
22.45	When air is used as reinforced insulation, clearances not reduced below the values specified in 29.1.3 due to deformation as a result of an external force applied to the enclosure		P
22.46	For programmable protective electronic circuits used to ensure compliance with the standard, the software contains measures to control the fault/error conditions in table R.1		N/A
	If the protective electronic circuit software is a part of the normal operation control, inspection of software shall be limited to relevant source code of safety controls or related software controls. (IEC 60335-2-40:2018)		N/A
	Alternative methods are used (IEC 60335-2-40:2018)		N/A

IEC 60335-2-40			
Clause	Requirement + Test	Result - Remark	Verdict
	Software that contains measures to control the fault/error conditions specified in table R.2 is to be specified in parts 2 for particular constructions or to address specific hazards		N/A
	These requirements are not applicable to software used for functional purpose or compliance with clause 11		N/A
22.47	Appliances connected to the water mains withstand the water pressure expected in normal use		N/A
	No leakage from any part, including any inlet water hose		N/A
22.48	Appliances connected to the water mains constructed to prevent backsiphonage of non-potable water		N/A
22.49	For remote operation, the duration of operation is to be set before the appliance can be started, unless		N/A
	the appliance switches off automatically or can operate continuously without hazard		N/A
22.50	Controls incorporated in the appliance take priority over controls actuated by remote operation		N/A
22.51	There is a control on the appliance manually adjusted to the setting for remote operation before the appliance can be operated in this mode		N/A
	There is a visual indication showing that the appliance is adjusted for remote operation		N/A
	These requirements not necessary on appliances that can operate as follows, without giving rise to a hazard:		—
	- continuously, or		N/A
	- automatically, or		N/A
	- remotely		N/A
22.52	Socket-outlets on appliances accessible to the user in accordance with the socket-outlet system used in the country in which the appliance is sold		N/A
22.53	Class II appliances and class III appliances that incorporate functionally earthed parts have at least double insulation or reinforced insulation between live parts and the functionally earthed parts		N/A
22.54	Button cells and batteries designated R1 not accessible without the aid of a tool, unless		N/A
	the cover of their compartment can only be opened after at least two independent movements have been applied simultaneously		N/A

IEC 60335-2-40			
Clause	Requirement + Test	Result - Remark	Verdict
22.55	Devices operated to stop the intended function of the appliance, if any, are to be distinguished from other manual devices by means of shape, size, surface texture or position	Size of remote control	P
	The requirement concerning position does not preclude use of a push on push off switch		N/A
	An indication when the device has been operated is given by:		—
	- tactile feedback from the actuator or from the appliance, or		N/A
	- reduction in heat output; or		N/A
	- audible and visible feedback		P
22.56	Detachable power supply part provided with the part of class III construction		N/A
22.57	The properties of non-metallic materials do not degrade from exposure to UV-C radiation, as specified in annex T		N/A
	This requirement does not apply to glass, ceramics or similar materials		N/A
22.101	Appliances intended to be fixed, securely fixed (IEC 60335-2-40:2013)		P
22.102.1	At least two thermal cut-outs in appliances with supplementary heating elements for air (first one be self-resetting thermal cut-out or a non-self-resetting thermal cut-out, the other be a non-self-resetting thermal cut-out.) (IEC 60335-2-40:2018)		N/A
22.102.2	Appliances provided with supplementary heaters for water incorporate non-self-resetting thermal cut-out, providing all-pole disconnection that operates separately from water thermostats (IEC 60335-2-40:2018)		N/A
	However, for appliances intended to be connected to fixed wiring, the neutral conductor need not be disconnected (IEC 60335-2-40:2018)		N/A
22.102.3	Thermal cut-outs of capillary type open in event of leakage from capillary tube (IEC 60335-2-40:2018)		N/A
22.103	Sensing and switching elements of electromechanical non-self-resetting cut-outs be functionally independent of other control devices. (IEC 60335-2-40:2018)		N/A
	If the switching element of a non self-resetting cut-out is operating a relay or contactor, the relay or contactor may also be operated by other control devices. Protective electronic circuits are covered by Clause 19. (IEC 60335-2-40:2018)		N/A

IEC 60335-2-40			
Clause	Requirement + Test	Result - Remark	Verdict
22.104	Containers of sanitary hot water heat pumps withstand twice permissible operating pressure in closed containers (IEC 60335-2-40:2018) or		N/A
	0,15 MPa in open containers (IEC 60335-2-40:2018)		N/A
	without leakage or rupture (IEC 60335-2-40:2018)		N/A
22.105	Air or vapour cushion in closed containers not exceeding 10 % (IEC 60335-2-40:2018)		N/A
22.106	Pressure relief devices operating at 0,1 MPa over permissible operating pressure (IEC 60335-2-40:2018)		N/A
22.107	Water outlet systems of open containers free from obstruction causing over-pressure (IEC 60335-2-40:2018)		N/A
	Vented containers of sanitary hot water heat pumps always open to the atmosphere through appropriate aperture (IEC 60335-2-40:2018)		N/A
22.108	Not vented open containers subjected to test in accordance with clause 22.104 to vacuum of 33 kPa for 15 min (IEC 60335-2-40:2018)		N/A
	Container show no deformation which result in a hazard (IEC 60335-2-40:2018)		N/A
22.109	Replacement of non-self-resetting thermal cut-outs does not damage other connections (IEC 60335-2-40:2018)		N/A
22.110	Non-self-resetting thermal cut-outs operate without short-circuiting live parts of different potential and without causing contact between live parts and enclosure (IEC 60335-2-40:2018)		N/A
	Test repeated five times without blowing 3 A fuse which connects appliance to earth (IEC 60335-2-40:2018)		N/A
	Electric strength test as specified in clause 16.3 for supplementary heating elements (IEC 60335-2-40:2018)		N/A
22.111	Manual resetting of thermostats not necessary after power supply interruption (IEC 60335-2-40:2018)		N/A
22.112	Construction of refrigerating system comply with requirements of Section 3 of ISO 5149 (IEC 60335-2-40:2018)		P
	Appliances using flammable refrigerants shall comply with the requirements and tests of Annex GG. (IEC 60335-2-40:2018)		P
22.113	Flammable refrigerant used, refrigerant tubing protected or enclosed to avoid mechanical damage (IEC 60335-2-40:2018)		P

IEC 60335-2-40			
Clause	Requirement + Test	Result - Remark	Verdict
	Tubing protected to extent that it will not be handled or used for carrying during moving of product (IEC 60335-2-40:2018)		P
	Tubing located within confines of cabinet considered to be protected from mechanical damage (IEC 60335-2-40:2018)		P
22.114	Flammable refrigerant used, low temperature solder alloys, such as lead/tin alloys, not acceptable for pipe connections or any other refrigerant pressure containing purposes. (IEC 60335-2-40:2018)		P
22.115	Refrigerant charge (mc) of all refrigerating systems within appliance employing A2 and A3 refrigerants, not exceed m ₃ defined in annex GG (IEC 60335-2-40:2018)	Refrigerating systems : A2L	N/A
	The refrigerant charge (m _c) in each refrigerating system employing A2L refrigerant not exceed m ₃ as defined in Annex GG. (IEC 60335-2-40:2018)	Refrigerating systems : A2L	P
22.116	Appliances using flammable refrigerants constructed that any leaked refrigerant not flow or stagnate so as to cause fire or explosion hazard in areas within appliance and connected ducts where electrical components, which could be a source of ignition and which could function under normal conditions or in event of leak, fitted (IEC 60335-2-40:2013/am1:2016)		P
	Separate components, such as thermostats, which charged with less than 0,5 g of flammable gas not considered to cause fire or explosion hazard in event of leakage of gas within component itself (IEC 60335-2-40:2018)		N/A
	Refrigerant pipes containing A2L refrigerant which connect refrigerating system components not be considered a source of leaked refrigerant for the purpose of evaluating potential for fire or explosion hazard relative to potential ignition sources within the appliance if the piping within the area of the appliance to be evaluated complies with all of the following; (IEC 60335-2-40:2018):		—
	- no connecting joints;		N/A
	- no bends with centreline bend radius less than 2,5 times the external pipe diameter;		N/A
	- protected from potential damage during normal operation, service or maintenance.		N/A
	All electrical components that could be a source of ignition and which could function under normal conditions or in the event of a leak, complies with at least one of the following: (IEC 60335-2-40:2018)		—
	- be located in an enclosure which complies with Clause 20 of IEC 60079-15:2010 for restricted breathing enclosures suitable for use with group IIA gases or the refrigerant used. ((IEC 60335-2-40:2018)		N/A

IEC 60335-2-40			
Clause	Requirement + Test	Result - Remark	Verdict
	- not be located in an area where a potentially flammable gas mixture will accumulate as demonstrated by the test of Annex FF. Electrical components not located in an area where a potentially flammable gas mixture will accumulate as demonstrated by the test of Annex FF are not considered an ignition source. (IEC 60335-2-40:2018)		N/A
	- for A2L refrigerants, located in an enclosure which is in compliance with Annex NN. (IEC 60335-2-40:2018)		N/A
	Components and apparatus complying with Clause 8 to 19 of IEC 60079-15:2010, for group IIA gases or the refrigerant used or an applicable standard that makes electrical components suitable for use in Zone 2, 1 or 0 as defined IEC 60079-14 are not considered as a source of ignition. (IEC 60335-2-40:2018)		P
	For A2L refrigerants, electrical components in compliance with Annex JJ are not considered a potential ignition source. (IEC 60335-2-40:2018)		N/A
	For A2L refrigerants, switching devices in compliance with all of the following are not considered a potential ignition source: (IEC 60335-2-40:2018)		—
	- the device is capable of 100 000 cycles per Clause 24; (IEC 60335-2-40:2018)		N/A
	- the switched electrical load (L_e) in kVA is less than or equal to: (IEC 60335-2-40:2018)		N/A
	$L_e = 5 \times (6,7/S_u)^4$ when breaking all phases; (IEC 60335-2-40:2018)		N/A
	$L_e = 2,5 \times (6,7/S_u)^4$ when breaking two legs of a three phase load, or when breaking one or two legs of a single phase load (IEC 60335-2-40:2018)	$L_e = \text{_____}$ (kVA)	N/A
	The burning velocity (S_u) for the purpose of determining the maximum quenching diameter (d_q) in Annex JJ and the maximum allowable electrical load L_e according to the above shall take into consideration the effect of humidity on burn velocity (S_u). (IEC 60335-2-40:2018)		N/A
	The burning velocity (S_u) be the highest value of (IEC 60335-2-40:2018)		—
	- as specified in ISO 817; or (IEC 60335-2-40:2018)		N/A
	- as measured in humid air at $27 \text{ }^\circ\text{C} \pm 0,5 \text{ C}$ dew point at 101,3 kPa containing $21,0 \pm 0,1 \%$ O ₂ excluding water vapour determined at the nominal composition as specified in ISO 817. (IEC 60335-2-40:2018)		N/A
	Burning velocity (S_u) (cm/s).....: (IEC 60335-2-40:2018)	$S_u = \text{_____}$ (cm/s)	N/A

IEC 60335-2-40			
Clause	Requirement + Test	Result - Remark	Verdict
	For appliances with A2L refrigerants, electrostatic air cleaners and similar devices which may produce electrical arcing during normal operation that could ignite the refrigerant used, and which are installed in the unit airstream or connecting ducts, are not considered as a potential ignition source if the airflow is monitored and the energy source of the electric arcing is switched off when the airflow is below the minimum airflow according to Annex GG. (IEC 60335-2-40:2018)		N/A
22.117	Hot surfaces		--
22.117.1	Temperatures on surfaces that exposed to leakage of flammable refrigerants not exceed maximum allowable surface temperature given in Annex BB (IEC 60335-2-40:2018)		N/A
	Flammable refrigerants except A2L refrigerants not listed in Annex BB, the maximum allowable surface temperature is determined by AIT reduced by 100 K. (IEC 60335-2-40:2018)	Measured surface temperature: _____ (°C)	N/A
	A2L refrigerants not listed in Annex BB, the maximum allowable surface temperature is determined by the highest of AIT reduced by 100 K or, if tested per annex KK, the hot surface ignition temperature reduced by 100 K, but not higher than 700 °C. (IEC 60335-2-40:2018)	Measured surface temperature: _____ (°C)	N/A
	Surfaces in compliance with this clause not be considered a potential ignition source. (IEC 60335-2-40:2018)		N/A
22.117.2	Temperatures on surfaces that may be exposed to leakage of A2L refrigerants may exceed the maximum allowable surface temperature in case of loss of airflow when all the following applies: (IEC 60335-2-40:2018):		—
	- the temperatures are not exceeding the maximum allowable surface temperature with the minimum airflow; (IEC 60335-2-40:2018)		N/A
	- the airflow is supervised and the heat source of the hot surface is switched off, when the airflow is below the minimum airflow. (IEC 60335-2-40:2018)		N/A
22.117.3	Open source of ignition, including open flames, pilot flames, direct spark ignition or hot surface ignition or other similar sources of ignition in the combustion air-stream, if the combustion air is drawn from an unventilated space in which leaked refrigerant may enter through the combustion air intake, are allowed, when these appliances are provided with a flame arrest or equivalent to ensure that in the event of an ignition, the flame will not propagate. (IEC 60335-2-40:2018)		N/A

IEC 60335-2-40			
Clause	Requirement + Test	Result - Remark	Verdict
22.118	Flammable refrigerant used, all appliances charged with refrigerant at manufacturing location or charged on site as recommended by manufacturer (IEC 60335-2-40:2018)		P
	Part of appliance that charged on site, which requires brazing or welding in installation not shipped with flammable refrigerant charge. Joints made in installation between parts of refrigerating system, with at least one part charged, made in accordance with following: (IEC 60335-2-40:2018):		—
	- A brazed, welded, or mechanical connection shall be made before opening the valves to permit refrigerant to flow between the refrigerating system parts. A vacuum valve shall be provided to evacuate the interconnecting pipe and/or any uncharged refrigerating system part (IEC 60335-2-40:2018)		P
	- Mechanical connectors used indoors shall comply with ISO 14903. When mechanical connectors are reused indoors, sealing parts shall be renewed. When flared joints are reused indoors, the flare part shall be re-fabricated. (IEC 60335-2-40:2018)		N/A
	- Refrigerant tubing shall be protected or enclosed to avoid damage (IEC 60335-2-40:2018)		P
	Flexible refrigerant connectors (such as connecting lines between the indoor and outdoor unit) that may be displaced during normal operations shall be protected against mechanical damage (IEC 60335-2-40:2018)		P
22.119	Condensing units and evaporating units are equipped with a pressure limiting device or equivalent to assure that the equipment does not exceed the maximum allowable pressure. (IEC 60335-2-40:2018)		N/A
	For partial units, the interconnection circuits for signal communication between each unit be of the same type. (IEC 60335-2-40:2018)		N/A
	SELV level connection is recommended. (IEC 60335-2-40:2018)		N/A
22.120	Partial units shall be provided with a means of connection to the supply mains and not be powered by an electrical circuit from another appliance. (IEC 60335-2-40:2018)		N/A
22.121	For the installation condition of appliances using an A2L refrigerant and where a refrigerant detection system is applied to fulfil the requirements of Annex GG, the refrigerant sensor of the system shall be located where leaking refrigerant is likely to stagnate. The sensor be located: (IEC 60335-2-40:2018):		—
	- within the unit for appliances connected via an air duct system to one or more rooms, (IEC 60335-2-40:2018)		N/A

IEC 60335-2-40			
Clause	Requirement + Test	Result - Remark	Verdict
	- within the unit where release height h0 as determined in Clause GG.2 is not more than 1,5 m (IEC 60335-2-40:2018)		N/A
	- where the release height h0 as determined in Clause GG.2 is more than 1,5 m, the sensor may be located within (IEC 60335-2-40:2018)		N/A
	- the unit, or (IEC 60335-2-40:2018)		N/A
	- 100 mm or less directly below the unit, or (IEC 60335-2-40:2018)		N/A
	- remote located within 300 mm above the floor. If a remote located sensor is specified by the manufacturer, the instructions shall state that the sensor shall be located within (IEC 60335-2-40:2018)		N/A
	1)..... 1 0 m horizontal distance in line sight of the unit and on a wall within the room in which the unit is installed, or (IEC 60335-2-40:2018)		N/A
	2)..... 7 m, if not in line sight of the unit, and on a wall within the room in which the unit is installed. The distance from the unit to the sensor shall be measured as the shortest horizontal unobstructed path between the unit and the nearest sensor. (IEC 60335-2-40:2018)		N/A
	For installations with field applied mechanical joints which are exposed in the occupied space, the instructions state that a sensor be located (IEC 60335-2-40:2018):		—
	- remote located within 2 m horizontal distance in line of sight of the unit and on a wall within the room in which the unit is installed; and (IEC 60335-2-40:2018)		N/A
	- 100 mm above the floor where h0 is not more than 300 mm from the floor; or (IEC 60335-2-40:2018)		N/A
	- 300 mm above the floor where h0 is greater than 300 mm from the floor. (IEC 60335-2-40:2018)		N/A
	The following mechanical joints not require that sensor: (IEC 60335-2-40:2018)		—
	- mechanical joints in compliance with ISO 14903; (IEC 60335-2-40:2018)		N/A
	- joints in enclosures which vent to the unit or to the outside (IEC 60335-2-40:2018)		N/A

IEC 60335-2-40			
Clause	Requirement + Test	Result - Remark	Verdict
	Tested in accordance with Annex MM. Remote located sensor location is not tested. Sensors located 100 mm or less directly below the unit are not considered remote sensors. (IEC 60335-2-40:2018)		N/A
22.122	Refrigerant detection systems that are required by this standard for A2L refrigerants comply with Annex LL. (IEC 60335-2-40:2018)		N/A
22.123	For appliances connected via an air duct system to one or more rooms using an A2L refrigerant (IEC 60335-2-40:2018)		—
	- which include a separate section with refrigerant containing components except pipes (e.g. compressors, condensers), and (IEC 60335-2-40:2018)		N/A
	- which are isolated from the airflow and located in a room smaller than Amin per Clause GG.2, (IEC 60335-2-40:2018)		N/A
	then Clause GG.4 (ventilated enclosure) can be applied, where the required ventilation can be provided by the ventilation system. That section shall have an opening to the outdoor or indoor air-stream to be able to ventilate the refrigerant to an area in compliance with Annex GG. (IEC 60335-2-40:2018)		N/A
22.124	If a refrigerant detection system is used, care has to be taken that in the event of a leak, accumulating refrigerant will be detected properly in every operating mode (e.g. indoor fan off). (IEC 60335-2-40:2018)		N/A
	Tested in accordance with Annex MM. Remote located sensor location is not tested. Sensors located 100 mm or less directly below the unit are not considered remote sensors. (IEC 60335-2-40:2018)		N/A
22.125	Refrigerating systems that fulfil all of the following conditions be considered enhanced tightness refrigerating systems: (IEC 60335-2-40:2018)		--
	bullet a) to bullet f) (IEC 60335-2-40:2018)		N/A
	g) vibrations exceeding 0,30 G RMS, when measured with a low pass filter at 200 Hz, are not allowed in the refrigerant containing parts in the occupied space under normal operation (IEC 60335-2-40:2018)		N/A
	h) indoor heat exchangers be protected from damage in the event of freezing (IEC 60335-2-40:2018)		N/A

IEC 60335-2-40			
Clause	Requirement + Test	Result - Remark	Verdict
	i) the maximum speed of the fan, in normal operation, shall be less than 90 % of the maximum allowable fan speed as specified by the manufacturer of the fan wheel. If the manufacturer does not specify a maximum allowable fan speed then the fan wheel shall be tested as described. (IEC 60335-2-40:2018)		N/A
22.126	Germicidal lamps are limited to low pressure mercury lamps with a quartz envelope having a continuous spectral irradiance at 254 nm. (IEC 60335-2-40:2018)		N/A
22.127	Appliance enclosure, UV-C lamps and UV-C barriers be located in such a manner that the UV-C spectral irradiance is not emitted outside the unit into an occupied space at a level exceeding the irradiance limit specified in 32.101.1. (IEC 60335-2-40:2018)		N/A
	Appliance indoor airflow inlet and outlet be considered as possible radiation paths. The unit filters are not considered UV-C barriers. (IEC 60335-2-40:2018)		N/A
22.128	For appliances that employ UV-C germicidal lamp systems and which have doors and/or panels that provide direct access to an area within the appliance where the measured UV-C spectral irradiance is greater than 1,7 $\mu\text{W}/\text{cm}^2$, the doors and/or panels be equipped with an interlock device that terminates the power to the lamps when opened. (IEC 60335-2-40:2018)		N/A
	If a switch is used to de-energize the UV-C lamps so as to meet the requirement, it is not possible to operate the switch with test probe B of IEC 61032. (IEC 60335-2-40:2018)		N/A
22.129	For user maintenance access areas, the UV-C spectral irradiance not exceed the limit specified in 32.101.2 with the access panels opened or removed as needed to perform the required user maintenance. (IEC 60335-2-40:2018)		N/A
	Panels that are opened or removed to perform user maintenance are required to be closed or put back in place for proper operation of the appliance. (IEC 60335-2-40:2018)		N/A
22.130	If the replacement of the UV-C lamp is allowed by the user, the appliance shall be constructed so that (IEC 60335-2-40:2018)		--
	- the replacement of the UV-C lamp is easily possible (IEC 60335-2-40:2018)		N/A

IEC 60335-2-40			
Clause	Requirement + Test	Result - Remark	Verdict
	- if screws or components are omitted or incorrectly positioned or fastened, the appliance is rendered inoperable or manifestly incomplete. (IEC 60335-2-40:2018)		N/A
22.131	Appliances that employ refrigerants in a transcritical refrigerating system are equipped with a pressure-limiting device that operates no greater than the maximum allowable pressure plus the tolerance of the pressure-limiting device. (IEC 60335-2-40:2018)		N/A
23	INTERNAL WIRING		--
23.1	Wireways smooth and free from sharp edges		P
	Wires protected against contact with burrs, cooling fins etc.		P
	Wire holes in metal well-rounded or provided with bushings		N/A
	Wiring effectively prevented from coming into contact with moving parts		P
23.2	Beads etc. on live wires cannot change their position, and are not resting on sharp edges		N/A
	Beads inside flexible metal conduits contained within an insulating sleeve		N/A
23.3	Electrical connections and internal conductors movable relatively to each other not exposed to undue stress		N/A
	Flexible metallic tubes not causing damage to insulation of conductors		N/A
	Open-coil springs not used		N/A
	Adequate insulating lining provided inside a coiled spring, the turns of which touch one another		N/A
	No damage after 10 000 flexings for conductors flexed during normal use, or		N/A
	100 flexings for conductors flexed during user maintenance		N/A
	Electric strength test of 16.3, 1000 V between live parts and accessible metal parts		N/A
	Not more than 10 % of the strands of any conductor broken, and		N/A
	not more than 30 % for wiring supplying circuits that consume no more than 15 W		N/A
23.4	Bare internal wiring sufficiently rigid and fixed		N/A
23.5	The insulation of internal wiring subjected to the supply mains voltage withstanding the electrical stress likely to occur in normal use		P

IEC 60335-2-40			
Clause	Requirement + Test	Result - Remark	Verdict
	Basic insulation electrically equivalent to the basic insulation of cords complying with IEC 60227 or IEC 60245, or		N/A
	no breakdown when a voltage of 2000 V is applied for 15 min between the conductor and metal foil wrapped around the insulation		P
	For class II construction, the requirements for supplementary insulation and reinforced insulation apply,		P
	except that the sheath of a cord complying with IEC 60227 or IEC 60245 may provide supplementary insulation.		N/A
	A single layer of internal wiring insulation does not provide reinforced insulation		P
23.6	Sleeving used as supplementary insulation on internal wiring retained in position by clamping at both ends, or		N/A
	be such that it can only be removed by breaking or cutting		N/A
23.7	The colour combination green/yellow only used for earthing conductors		P
23.8	Aluminium wires not used for internal wiring		P
23.9	Stranded conductors not consolidated by soldering where they are subjected to contact pressure, unless		P
	the contact pressure is provided by spring terminals		N/A
23.10	The insulation and sheath of internal wiring, incorporated in external hoses for the connection of an appliance to the water mains, at least equivalent to that of light polyvinyl chloride sheathed flexible cord (60227 IEC 52)		P
23.101	Internal wiring that is exposed to direct or reflected UV-C radiation be UV-C resistant. (IEC 60335-2-40:2018)		N/A
	Samples of the internal wiring are conditioned in accordance with Annex OO. (IEC 60335-2-40:2018)		N/A
	On completion of the conditioning, the cable is wrapped in metal foil and is wound around a conductive mandrel 15 mm in diameter for three turns. (IEC 60335-2-40:2018)		N/A
	A voltage of 2 000 V is applied for 15 min between the conductor and the mandrel. (IEC 60335-2-40:2018)		N/A
	No breakdown. (IEC 60335-2-40:2018)		N/A
24	COMPONENTS		--

IEC 60335-2-40			
Clause	Requirement + Test	Result - Remark	Verdict
24.1	Components comply with safety requirements in relevant IEC standards		P
	List of components.....:	(see appended table)	P
	Motors not required to comply with IEC 60034-1, they are tested as part of the appliance		P
	Relays tested as part of the appliance, or		P
	alternatively acc. to IEC 60730-1, and meeting the additional requirements in IEC 60335-1		N/A
	The requirements of clause 29 apply between live parts of components and accessible parts of the appliance		P
	Components can comply with the requirements for clearances and creepage distances for functional insulation in the relevant component standard		P
	30.2 of this standard apply to parts of non-metallic material in components including parts of non-metallic material supporting current-carrying connections		P
	Components that have not been previously tested to comply with the IEC standard for the relevant component are tested according to the requirements of 30.2		P
	Components that have been previously tested to comply with the resistance to fire requirements in the IEC standard for the relevant component need not be retested provided the specified conditions are met		P
	If these conditions are not satisfied, the component is tested as part of the appliance.		N/A
	Power electronic converter circuits not required to comply with IEC 62477-1, they are tested as part of the appliance		P
	If components have not been tested and found to comply with relevant IEC standard for the number of cycles specified, they are tested in accordance with 24.1.1 to 24.1.9		P
	For components mentioned in 24.1.1 to 24.1.9 no additional tests specified in the relevant component standard are necessary other than those specified in 24.1.1 to 24.1.9		P
	Components not tested and found to comply with relevant IEC standard and components not marked or not used in accordance with its marking, tested under the conditions occurring in the appliance		P

IEC 60335-2-40			
Clause	Requirement + Test	Result - Remark	Verdict
	Lampholders and starterholders that have not being tested and found to comply with the relevant IEC standard, tested as a part of the appliance and additionally according to the gauging and interchangeability requirements of the relevant IEC standard		N/A
	No additional tests specified for nationally standardized plugs such as those detailed in IEC/TR 60083 or connectors complying with the standard sheets of IEC 60320-1 and IEC 60309		N/A
	Motor-compressors not tested according to IEC 60335-2-34 (not necessary to meet all requirements of IEC 60335-2-34) (IEC 60335-2-40:2018)		P
24.1.1	Capacitors likely to be permanently subjected to the supply voltage and used for radio interference suppression or for voltage dividing, comply with IEC 60384-14		P
	If the capacitors have to be tested, they are tested according to annex F		N/A
24.1.2	Transformers in associated switch mode power supplies comply with annex BB of IEC 61558-2-16		P
	Safety isolating transformers comply with IEC 61558-2-6		N/A
	If they have to be tested, they are tested according to annex G		N/A
24.1.3	Switches comply with IEC 61058-1, the number of cycles of operation being at least 10 000		N/A
	If they have to be tested, they are tested according to annex H		N/A
	If the switch operates a relay or contactor, the complete switching system is subjected to the test		N/A
	If the switch only operates a motor starting relay complying with IEC 60730-2-10 with the number of cycles of a least 10 000 as specified, the complete switching system need not be tested		N/A
24.1.4	Automatic controls comply with IEC 60730-1 with the relevant part 2. The number of cycles of operation being at least:		--
	- thermostats: 10 000		N/A
	- temperature limiters: 1 000		N/A
	- self-resetting thermal cut-outs:..... 3000 (IEC 60335-2-40:2018)		N/A
	- voltage maintained non-self-resetting thermal cut-outs: 1 000		N/A
	- other non-self-resetting thermal cut-outs: 300 (IEC 60335-2-40:2018)		N/A

IEC 60335-2-40			
Clause	Requirement + Test	Result - Remark	Verdict
	- timers: 3 000		N/A
	- energy regulators: 10 000		N/A
	- thermostats which control motor-compressor (IEC 60335-2-40:2018) 100 000	Electronic thermostat Relay: 100000 cycles	P
	- motor-compressor starting relays (IEC 60335-2-40:2018) 100 000		N/A
	- automatic thermal motor-protectors for hermetic and semi-hermetic type motor-compressors (not less than number of operations during locked rotor test) (IEC 60335-2-40:2018) min 2000		N/A
	- manual reset thermal motor-protectors for hermetic and semi-hermetic type motor-compressors (IEC 60335-2-40:2018) 50	Hermetic compressor	P
	- other automatic thermal motor-protectors (IEC 60335-2-40:2018) 2000		N/A
	- other manual reset thermal motor-protectors (IEC 60335-2-40:2018) 30		N/A
	- refrigerant detection systems self-resetting (IEC 60335-2-40:2018) 300		N/A
	- refrigerant detection systems non self-resetting (IEC 60335-2-40:2018) 30		N/A
	- electromechanical proof of airflow control (IEC 60335-2-40:2018) 100 000		N/A
	- self-resetting electrical pressure-limiting device (IEC 60335-2-40:2018) 3 000		N/A
	- non-self-resetting electrical pressure-limiting device (IEC 60335-2-40:2018) 300		N/A
	The number of cycles for controls operating during clause 11 need not be declared, if the appliance meets the requirements of this standard when they are short-circuited		N/A
	Thermal motor protectors are tested in combination with their motor under the conditions specified in annex D		N/A
	For water valves containing live parts and that are incorporated in external hoses for connection of an appliance to the water mains, the degree of protection declared for subclause 6.5.2 of IEC 60730-2-8 is IPX7		N/A
	Thermal cut-outs of the capillary type comply with the requirements for type 2.K controls in IEC 60730-2-9		N/A
24.1.5	Appliance couplers comply with IEC 60320-1		N/A

IEC 60335-2-40			
Clause	Requirement + Test	Result - Remark	Verdict
	However, for class II appliances classified higher than IPX0, the appliance couplers comply with IEC 60320-2-3		N/A
	Interconnection couplers comply with IEC 60320-2-2		N/A
24.1.6	Small lamp holders similar to E10 lampholders comply with IEC 60238, the requirements for E10 lampholders being applicable		N/A
24.1.7	For remote operation of the appliance via a telecommunication network, the relevant standard for the telecommunication interface circuitry in the appliance is IEC 62151		N/A
24.1.8	The relevant standard for thermal links is IEC 60691		N/A
	Thermal links not complying with IEC 60691 are considered to be an intentionally weak part for the purposes of clause 19		N/A
24.1.9	Contactors and relays, other than motor starting relays, tested as part of the appliance		P
	They are also tested in accordance with clause 17 of IEC 60730-1, the number of cycles of operations in 24.1.4 selected according to the contactor or relay function in the appliance		P
24.2	Appliances not fitted with:		--
	- switches, automatic controls or power supplies in flexible cords		N/A
	- devices causing the protective device in the fixed wiring to operate in the event of a fault in the appliance		P
	- thermal cut-outs that can be reset by soldering, unless		P
	the solder has a melting point of at least 230 °C		N/A
24.3	Switches intended for all-pole disconnection of stationary appliances are directly connected to the supply terminals and have a contact separation in all poles, providing full disconnection under overvoltage category III conditions		N/A
24.4	Plugs and socket-outlets for extra-low voltage circuits and heating elements, not interchangeable with plugs and socket-outlets listed in IEC/TR 60083 or IEC 60906-1 or with connectors and appliance inlets complying with the standard sheets of IEC 60320-1		N/A
24.5	Capacitors in auxiliary windings of motors marked with their rated voltage and capacitance, and used accordingly		N/A

IEC 60335-2-40			
Clause	Requirement + Test	Result - Remark	Verdict
	Voltage across capacitors in series with a motor winding does not exceed 1,1 times rated voltage, when the appliance is supplied at 1,1 times rated voltage under minimum load		N/A
24.6	Working voltage of motors connected to the supply mains and having basic insulation that is inadequate for the rated voltage of the appliance, not exceeding 42 V		N/A
	In addition, the motors comply with the requirements of annex I		N/A
24.7	Detachable hose-sets for connection of appliances to the water mains comply with IEC 61770		N/A
	They are supplied with the appliance		N/A
	Appliances intended to be permanently connected to the water mains not connected by a detachable hose-set		N/A
24.8	Motor running capacitors in appliances for which 30.2.3 is applicable and that are permanently connected in series with a motor winding, not causing a hazard in event of a failure		N/A
	One or more of the following conditions are to be met:		--
	- the capacitors are of class S2 or S3 according to IEC 60252-1		N/A
	- the capacitors are housed within a metallic or ceramic enclosure		N/A
	- the distance of separation of the outer surface to adjacent non-metallic parts exceeds 50 mm		N/A
	- adjacent non-metallic parts within 50 mm withstand the needle-flame test of annex E		N/A
	- adjacent non-metallic parts within 50 mm classified as at least V-1 according to IEC 60695-11-10		N/A
24.101	Replaceable parts of thermal control devices identified by marking (IEC 60335-2-40:2018)		N/A
24.102	Pressure-limiting devices used in transcritical refrigerating systems complies with IEC 60730-2-6 and (IEC 60335-2-40:2018)		--
	- be of type 2A or 2B; (IEC 60335-2-40:2018)		N/A
	- have a trip free mechanism of type 2 J (IEC 60335-2-40:2018)		N/A
	- the deviation and drift not exceed + 0 %. (IEC 60335-2-40:2018)		N/A
25	SUPPLY CONNECTION AND EXTERNAL FLEXIBLE CORDS		--
25.1	Appliance not intended for permanent connection to fixed wiring, means for connection to the supply:		--

IEC 60335-2-40			
Clause	Requirement + Test	Result - Remark	Verdict
	- supply cord fitted with a plug, the current rating and voltage rating of the plug being not less than the corresponding ratings of its associated appliance		N/A
	- an appliance inlet having at least the same degree of protection against moisture as required for the appliance, or		N/A
	- pins for insertion into socket-outlets		N/A
	Supply cord fitted with plug provided, if (IEC 60335-2-40:2018):		--
	- appliance only for indoor use (IEC 60335-2-40:2018)		N/A
	- marked with rating of 25 A or less and (IEC 60335-2-40:2018)		N/A
	- complies with code requirements of country where it will be used (IEC 60335-2-40:2018)		N/A
	Appliance inlet not allowed (IEC 60335-2-40:2018)		N/A
25.2	Appliance not provided with more than one means of connection to the supply mains		P
	Stationary appliance for multiple supply may be provided with more than one means of connection, provided electric strength test of 1250 V for 1 min between each means of connection causes no breakdown		N/A
25.3	Appliance intended to be permanently connected to fixed wiring provided with one of the following means for connection to the supply mains:		--
	- a set of terminals allowing the connection of a flexible cord		N/A
	- a fitted supply cord		N/A
	- a set of supply leads accommodated in a suitable compartment		N/A
	- a set of terminals for the connection of cables of fixed wiring, cross-sectional areas specified in 26.6, and the appliance allows the connection of the supply conductors after the appliance has been fixed to its support		P
	- a set of terminals and cable entries, conduit entries, knock-outs or glands, allowing connection of appropriate types of cable or conduit, and the appliance allows the connection of the supply conductors after the appliance has been fixed to its support		N/A
	For a fixed appliance constructed so that parts can be removed to facilitate easy installation, this requirement is met if it is possible to connect the fixed wiring without difficulty after a part of the appliance has been fixed to its support		P

IEC 60335-2-40			
Clause	Requirement + Test	Result - Remark	Verdict
25.4	Cable and conduit entries, rated current of appliance not exceeding 16 A, dimension according to table 10 (mm).....:		N/A
	Introduction of conduit or cable does not reduce clearances or creepage distances below values specified in clause 29		N/A
25.5	Method for assembling the supply cord to the appliance:		--
	- type X attachment		N/A
	- type Y attachment		P
	- type Z attachment, if allowed in relevant part 2		N/A
	Type X attachment, other than those with a specially prepared cord, not used for flat twin tinsel cords		N/A
	For multi-phase appliances supplied with a supply cord and that are intended to be permanently connected to fixed wiring, the supply cord is assembled to the appliance by type Y attachment		N/A
25.6	Plugs fitted with only one flexible cord		N/A
25.7	Supply cords, other than for class III appliances, being one of the following types:		--
	- rubber sheathed (at least 60245 IEC 53)		N/A
	- polychloroprene sheathed (at least 60245 IEC 57)		N/A
	- polyvinyl chloride sheathed. Not used if they are likely to touch metal parts having a temperature rise exceeding 75 K during the test of clause 11		--
	- light polyvinyl chloride sheathed cord (60227 IEC 52), for appliances not exceeding 3 kg		N/A
	- ordinary polyvinyl chloride sheathed cord (60227 IEC 53), for other appliances		N/A
	- heat resistant polyvinyl chloride sheathed. Not used for type X attachment other than specially prepared cords		--
	- heat-resistant light polyvinyl chloride sheathed cord (60227 IEC 56), for appliances not exceeding 3 kg		N/A
	- heat-resistant polyvinyl chloride sheathed cord (60227 IEC 57), for other appliances		N/A
	- halogen-free, low smoke, thermoplastic insulated and sheathed		--
	- light duty halogen-free low smoke flexible cable (62821 IEC 101) for circular cable and (62821 IEC 101f) for flat cable		N/A
	- Ordinary duty halogen-free low smoke flexible cable (62821 IEC 102) for circular cable and (62821 IEC 102f) for flat cable		N/A
	Supply cords for class III appliances adequately insulated		N/A

IEC 60335-2-40			
Clause	Requirement + Test	Result - Remark	Verdict
	Test with 500 V for 2 min for supply cords of class III appliances that contain live parts		N/A
	Supply cords for outdoor use not lighter than polychloroprene sheathed flexible cord (60245 IEC 57) (IEC 60335-2-40:2018)	H07RN-F or 60245 IEC66 (See installation manual)	P
25.8	Nominal cross-sectional area of supply cords not less than table 11; rated current (A); cross-sectional area (mm ²)	Max Current: 6,75A; 7,75A; 8,95A; 9,50A; 10,50A; 12,80A Cross-sectional area: 1,5mm ² and 2,5 mm ² or more (See installation manual)	P
25.9	Supply cords not in contact with sharp points or edges		P
25.10	Supply cord of class I appliances have a green/yellow core for earthing		N/A
	In multi-phase appliances, the colour of the neutral conductor of the supply cord is blue		N/A
	Where additional neutral conductors are provided in the supply cord:		--
	- other colours may be used for these additional neutral conductors;		N/A
	- all of the neutral conductors and line conductors are identified by marking using the alpha numeric notation specified in IEC 60445		N/A
	- the supply cord is fitted to the appliance		N/A
25.11	Conductors of supply cords not consolidated by soldering where they are subject to contact pressure, unless		P
	the contact pressure is provided by spring terminals		N/A
25.12	Insulation of the supply cord not damaged when moulding the cord to part of the enclosure		N/A
25.13	Inlet openings so constructed as to prevent damage to the supply cord		P
	If it is not evident that the supply cord can be introduced without risk of damage, a non-detachable lining or bushing complying with 29.3 for supplementary insulation provided		N/A
	If unsheathed supply cord, a similar additional bushing or lining is required, unless the appliance is		N/A
	class 0, or		N/A
	a class III appliance not containing live parts		N/A
25.14	Supply cords moved while in operation adequately protected against excessive flexing		N/A
	Flexing test, as described:		--
	- applied force (N)		N/A

IEC 60335-2-40			
Clause	Requirement + Test	Result - Remark	Verdict
	- number of flexings.....:		N/A
	The test does not result in:		--
	- short-circuit between the conductors, such that the current exceeds a value of twice the rated current		N/A
	- breakage of more than 10% of the strands of any conductor		N/A
	- separation of the conductor from its terminal		N/A
	- loosening of any cord guard		N/A
	- damage to the cord or the cord guard		N/A
	- broken strands piercing the insulation and becoming accessible		N/A
25.15	For appliances with supply cord and appliances to be permanently connected to fixed wiring by a flexible cord, conductors of the supply cord relieved from strain, twisting and abrasion by use of cord anchorage		P
	The cord cannot be pushed into the appliance to such an extent that the cord or internal parts of the appliance can be damaged		P
	Pull and torque test of supply cord:		--
	- fixed appliances: pull 100 N; torque (not on automatic cord reel) (Nm)		P
	- other appliances: values shown in table 12: mass (kg); pull (N); torque (not on automatic cord reel) (Nm)		P
	Cord not damaged and max. 2 mm displacement of the cord		P
25.16	Cord anchorages for type X attachments constructed and located so that:		--
	- replacement of the cord is easily possible		N/A
	- it is clear how the relief from strain and the prevention of twisting are obtained		N/A
	- they are suitable for different types of supply cord		N/A
	- cord cannot touch the clamping screws of cord anchorage if these screws are accessible, unless		N/A
	they are separated from accessible metal parts by supplementary insulation		N/A
	- the cord is not clamped by a metal screw which bears directly on the cord		N/A
	- at least one part of the cord anchorage securely fixed to the appliance, unless		N/A
	it is part of a specially prepared cord		N/A

IEC 60335-2-40			
Clause	Requirement + Test	Result - Remark	Verdict
	- screws which have to be operated when replacing the cord do not fix any other component, unless		N/A
	the appliance becomes inoperative or incomplete or the parts cannot be removed without a tool		N/A
	- if labyrinths can be bypassed the test of 25.15 is nevertheless withstood		N/A
	- for class 0, 0I and I appliances they are of insulating material or are provided with an insulating lining, unless		N/A
	failure of the insulation of the cord does not make accessible metal parts live		N/A
	- for class II appliances they are of insulating material, or		N/A
	if of metal, they are insulated from accessible metal parts by supplementary insulation		N/A
	After the test of 25.15, under the conditions specified, the conductors have not moved by more than 1 mm in the terminals		N/A
25.17	Adequate cord anchorages for type Y and Z attachment, test with the cord supplied with the appliance		P
25.18	Cord anchorages only accessible with the aid of a tool, or		P
	Constructed so that the cord can only be fitted with the aid of a tool		P
25.19	Type X attachment, glands not used as cord anchorage in portable appliances		N/A
	Tying the cord into a knot or tying the cord with string not used		N/A
25.20	The conductors of the supply cord for type Y and Z attachment insulated from accessible metal parts		P
25.21	Space for supply cord for type X attachment or for connection of fixed wiring constructed:		--
	- to permit checking of conductors with respect to correct positioning and connection before fitting any cover		P
	- so there is no risk of damage to the conductors or their insulation when fitting the cover		P
	- for portable appliances, so that the uninsulated end of a conductor, if it becomes free from the terminal, prevented from contact with accessible metal parts		N/A
	2 N test to the conductor for portable appliances; no contact with accessible metal parts		N/A

IEC 60335-2-40			
Clause	Requirement + Test	Result - Remark	Verdict
25.22	Appliance inlets:		--
	- live parts not accessible during insertion or removal		N/A
	Requirement not applicable to appliance inlets complying with IEC 60320-1		N/A
	- connector can be inserted without difficulty		N/A
	- the appliance is not supported by the connector		N/A
	- not for cold conditions if temp. rise of external metal parts exceeds 75 K during clause 11, unless		N/A
	the supply cord is unlikely to touch such metal parts		N/A
25.23	Interconnection cords comply with the requirements for the supply cord, except that:		--
	- the cross-sectional area of the conductors is determined on the basis of the maximum current during clause 11		P
	- the thickness of the insulation may be reduced		P
	- for class I or class II appliance with class III construction, the cross sectional areas of the conductors need not comply with 25.8 if specified conditions are met		N/A
	If necessary, electric strength test of 16.3		N/A
25.24	Interconnection cords not detachable without the aid of a tool if compliance with this standard is impaired when they are disconnected		P
25.25	Dimensions of pins that are inserted into socket-outlets compatible with the dimensions of the relevant socket-outlet.		N/A
	Dimensions of pins and engagement face in accordance with the dimensions of the relevant plug in IEC/TR 60083		N/A
26	TERMINALS FOR EXTERNAL CONDUCTORS		--
26.1	Appliances provided with terminals or equally effective devices for connection of external conductors		P
	Terminals only accessible after removal of a non-detachable cover, except		P
	for class III appliances that do not contain live parts		N/A
	Earthing terminals may be accessible if a tool is required to make the connections and means are provided to clamp the wire independently from its connection		N/A

IEC 60335-2-40			
Clause	Requirement + Test	Result - Remark	Verdict
26.2	Appliances with type X attachment and appliances for the connection of cables of fixed wiring provided with terminals in which connections are made by means of screws, nuts or similar devices, unless		P
	the connections are soldered		N/A
	Screws and nuts not used to fix any other component, except		P
	internal conductors, if so arranged that they are unlikely to be displaced when fitting the supply conductors		P
	If soldered connections used, the conductor so positioned or fixed that reliance is not placed on soldering alone, unless		N/A
	barriers provided so that neither clearances nor creepage distances between live parts and other metal parts reduced below the values for supplementary insulation if the conductor becomes free at the soldered joint		N/A
26.3	Terminals for type X attachment and for connection of cables of fixed wiring so constructed that the conductor is clamped between metal surfaces with sufficient contact pressure but without damaging the conductor		P
	Terminals fixed so that when the clamping means is tightened or loosened:		--
	- the terminal does not become loose		P
	- internal wiring is not subjected to stress		P
	- neither clearances nor creepage distances are reduced below the values in clause 29		P
	Compliance checked by inspection and by the test of subclause 9.6 of IEC 60999-1, the torque applied being equal to two-thirds of the torque specified (Nm)		P
	No deep or sharp indentations of the conductors		P
26.4	Terminals for type X attachment, except those having a specially prepared cord and those for the connection of cables of fixed wiring, no special preparation of conductors such as by soldering, use of cable lugs, eyelets or similar, and		P
	so constructed or placed that conductors prevented from slipping out when clamping screws or nuts are tightened		P
26.5	Terminals for type X attachment so located or shielded that if a wire of a stranded conductor escapes, no risk of accidental connection to other parts that result in a hazard		N/A
	Stranded conductor test, 8 mm insulation removed		N/A

IEC 60335-2-40			
Clause	Requirement + Test	Result - Remark	Verdict
	No contact between live parts and accessible metal parts and,		N/A
	for class II constructions, between live parts and metal parts separated from accessible metal parts by supplementary insulation only		N/A
26.6	Terminals for type X attachment and for connection of cables of fixed wiring suitable for connection of conductors with cross-sectional area according to table 13; rated current (A); nominal cross-sectional area (mm ²)	Max Current: 6,75A; 7,75A; 8,95A; 9,50A; 10,50A; 12,80A Cross-sectional area: 1,5mm ² and 2,5 mm ² or more (See installation manual)	P
	If a specially prepared cord is used, terminals need only be suitable for that cord		N/A
26.7	Terminals for type X attachment, except in class III appliances not containing live parts, accessible after removal of a cover or part of the enclosure		N/A
26.8	Terminals for the connection of fixed wiring, including the earthing terminal, located close to each other		P
26.9	Terminals of the pillar type constructed and located as specified		N/A
26.10	Terminals with screw clamping and screwless terminals not used for flat twin tinsel cords, unless		P
	conductors ends fitted with means suitable for screw terminals		N/A
	Pull test of 5 N to the connection		P
26.11	For type Y and Z attachment, soldered, welded, crimped or similar connections may be used		N/A
	For class II appliances, the conductor so positioned or fixed that reliance is not placed on soldering, welding or crimping alone		N/A
	If soldering, welding or crimping alone used, barriers provided so that clearances and creepage distances between live parts and other metal parts are not reduced below the values for supplementary insulation if the conductor becomes free		N/A
27	PROVISION FOR EARTHING		--
27.1	Accessible metal parts of class 0I and I appliances permanently and reliably connected to an earthing terminal or earthing contact of the appliance inlet		P
	Earthing terminals and earthing contacts not connected to the neutral terminal		P
	Class 0, II and III appliances have no provision for protective earthing		N/A

IEC 60335-2-40			
Clause	Requirement + Test	Result - Remark	Verdict
	Class II appliances and class III appliances can incorporate an earth for functional purposes		N/A
	Safety extra-low voltage circuits not earthed, unless		N/A
	protective extra-low voltage circuits		N/A
27.2	Clamping means of earthing terminals adequately secured against accidental loosening		P
	Terminals for the connection of external equipotential bonding conductors allow connection of conductors of 2,5 to 6 mm ² , and		N/A
	- do not provide earthing continuity between different parts of the appliance, and		N/A
	- conductors cannot be loosened without the aid of a tool		N/A
	Requirements not applicable to class II appliances and class III appliances that incorporate an earth for functional purposes		N/A
27.3	For a detachable part having an earth connection and being plugged into another part of the appliance, the earth connection is made before and separated after current-carrying connections when removing the part		N/A
	For appliances with supply cords, current-carrying conductors become taut before earthing conductor, if the cord slips out of the cord anchorage		N/A
	Requirements not applicable to class II appliances and class III appliances that incorporate an earth for functional purposes		N/A
27.4	No risk of corrosion resulting from contact between parts of the earthing terminal and the copper of the earthing conductor or other metal		P
	Parts providing earthing continuity, other than parts of a metal frame or enclosure, have adequate resistance to corrosion		P
	If of steel, these parts provided with an electroplated coating with a thickness at least 5 µm		P
	Adequate protection against rusting of parts of coated or uncoated steel, only intended to provide or transmit contact pressure		P
	In the body of the earthing terminal is a part of a frame or enclosure of aluminium or aluminium alloys, precautions taken to avoid risk of corrosion		N/A
	Requirements not applicable to class II appliances and class III appliances that incorporate an earth for functional purposes		N/A
27.5	Low resistance of connection between earthing terminal and earthed metal parts		P

IEC 60335-2-40			
Clause	Requirement + Test	Result - Remark	Verdict
	This requirement does not apply to connections providing earthing continuity in the protective extra-low voltage circuit, provided the clearances of basic insulation are based on the rated voltage of the appliance		N/A
	Requirements not applicable to class II appliances and class III appliances that incorporate an earth for functional purposes		N/A
	Resistance not exceeding 0,1 Ω at the specified low-resistance test (Ω)	0,03 Ω	P
	If the ground continuity between system components meets the minimum values specified in 27.5, it is considered to meet the requirements without dedicated grounding conductors. (IEC 60335-2-40:2018)		P
27.6	The printed conductors of printed circuit boards not used to provide earthing continuity in hand-held appliances.		N/A
	They may be used to provide earthing continuity in other appliances if at least two tracks are used with independent soldering points and the appliance complies with 27.5 for each circuit		N/A
	Requirements not applicable to class II appliances and class III appliances that incorporate an earth for functional purposes		N/A
28	SCREWS AND CONNECTIONS		--
28.1	Fixings, electrical connections and connections providing earthing continuity withstand mechanical stresses		P
	Screws not of soft metal liable to creep, such as zinc or aluminium		P
	Diameter of screws of insulating material min. 3 mm		N/A
	Screws of insulating material not used for any electrical connections or connections providing earthing continuity		N/A
	Screws used for electrical connections or connections providing earthing continuity screwed into metal		P
	Screws not of insulating material if their replacement by a metal screw can impair supplementary or reinforced insulation		N/A
	For type X attachment, screws to be removed for replacement of supply cord or for user maintenance, not of insulating material if their replacement by a metal screw impairs basic insulation		N/A

IEC 60335-2-40			
Clause	Requirement + Test	Result - Remark	Verdict
	For screws and nuts; torque-test as specified in table 14	(see appended table)	P
28.2	Electrical connections and connections providing earthing continuity constructed so that contact pressure is not transmitted through non-ceramic insulating material liable to shrink or distort, unless		P
	there is resiliency in the metallic parts to compensate for shrinkage or distortion of the insulating material		N/A
	This requirement does not apply to electrical connections in circuits of appliances for which:		--
	- 30.2.2 is applicable and that carry a current not exceeding 0,5 A		N/A
	- 30.2.3 is applicable and that carry a current not exceeding 0,2 A		P
28.3	Space-threaded (sheet metal) screws only used for electrical connections if they clamp the parts together		N/A
	Thread-cutting (self-tapping) screws and thread rolling screws only used for electrical connections if they generate a full form standard machine screw thread		N/A
	Thread-cutting (self-tapping) screws not used if they are likely to be operated by the user or installer		N/A
	Thread-cutting, thread rolling and space threaded screws may be used in connections providing earthing continuity provided it is not necessary to disturb the connection:		--
	- in normal use,		P
	- during user maintenance,		P
	- when replacing a supply cord having a type X attachment, or		N/A
	- during installation		P
	At least two screws being used for each connection providing earthing continuity, unless		P
	the screw forms a thread having a length of at least half the diameter of the screw		P
28.4	Screws and nuts that make mechanical connection secured against loosening if they also make electrical connections or connections providing earthing continuity		N/A
	This requirement does not apply to screws in the earthing circuit if at least two screws are used, or		P
	if an alternative earthing circuit is provided		N/A

IEC 60335-2-40			
Clause	Requirement + Test	Result - Remark	Verdict
	Rivets for electrical connections or connections providing earthing continuity secured against loosening if the connections are subjected to torsion		N/A
29	CLEARANCES, CREEPAGE DISTANCES AND SOLID INSULATION		--
	Clearances, creepage distances and solid insulation withstand electrical stress		P
	For coatings used on printed circuits boards to protect the microenvironment (Type 1) or to provide basic insulation (Type 2), annex J applies		N/A
	The microenvironment is pollution degree 1 under type 1 protection		N/A
	For type 2 protection, the spacing between the conductors before the protection is applied is not less than the values specified in Table 1 of IEC 60664-3		N/A
	These values apply to functional, basic, supplementary and reinforced insulation		N/A
	For motor-compressor not complying with IEC 60335-2-34, additions and modifications as specified (IEC 60335-2-40:2018)		P
29.1	Clearances not less than the values specified in table 16, taking into account the rated impulse voltage for the overvoltage categories of table 15, unless	(see appended table)	P
	for basic insulation and functional insulation they comply with the impulse voltage test of clause 14		N/A
	However, if the distances are affected by wear, distortion, movement of the parts or during assembly, the clearances for rated impulse voltages of 1500 V and above are increased by 0,5 mm and the impulse voltage test is not applicable		P
	For appliances intended for use at altitudes exceeding 2 000 m, the clearances in Table 16 is increased according to the relevant multiplier values in Table A.2 of IEC 60664-1		N/A
	Impulse voltage test is not applicable:		--
	- when the microenvironment is pollution degree 3, or		P
	- for basic insulation of class 0 and class 01 appliances, or		N/A
	- to appliances intended for use at altitudes exceeding 2 000 m		N/A
	Appliances are in overvoltage category II		P

IEC 60335-2-40			
Clause	Requirement + Test	Result - Remark	Verdict
	A force of 2 N is applied to bare conductors, other than heating elements		N/A
	A force of 30 N is applied to accessible surfaces		N/A
29.1.1	Clearances of basic insulation withstand the overvoltages, taking into account the rated impulse voltage		P
	The values of table 16 or the impulse voltage test of clause 14 are applicable	(see appended table)	P
	Clearance at the terminals of tubular sheathed heating elements may be reduced to 1,0 mm if the microenvironment is pollution degree 1		N/A
	Lacquered conductors of windings considered to be bare conductors		P
29.1.2	Clearances of supplementary insulation not less than those specified for basic insulation in table 16	(see appended table)	P
29.1.3	Clearances of reinforced insulation not less than those specified for basic insulation in table 16, using the next higher step for rated impulse voltage	(see appended table)	P
	For double insulation, with no intermediate conductive part between basic and supplementary insulation, clearances are measured between live parts and the accessible surface, and the insulation system is treated as reinforced insulation		P
29.1.4	Clearances for functional insulation are the largest values determined from:		--
	- table 16 based on the rated impulse voltage	(see appended table)	P
	- table F.7a in IEC 60664-1, frequency not exceeding 30 kHz		N/A
	- clause 4 of IEC 60664-4, frequency exceeding 30 kHz		N/A
	If values of table 16 are largest, the impulse voltage test of clause 14 may be applied instead, unless		N/A
	the microenvironment is pollution degree 3, or		P
	the distances can be affected by wear, distortion, movement of the parts or during assembly		N/A
	However, clearances are not specified if the appliance complies with clause 19 with the functional insulation short-circuited		N/A
	Lacquered conductors of windings considered to be bare conductors		P
	However, clearances at crossover points are not measured		P
	Clearance between surfaces of PTC heating elements may be reduced to 1 mm		N/A

IEC 60335-2-40			
Clause	Requirement + Test	Result - Remark	Verdict
29.1.5	Appliances having higher working voltages than rated voltage, clearances for basic insulation are the largest values determined from:		--
	- table 16 based on the rated impulse voltage:	2500	P
	- table F.7a in IEC 60664-1, frequency not exceeding 30 kHz		N/A
	- clause 4 of IEC 60664-4, frequency exceeding 30 kHz		N/A
	If clearances for basic insulation are selected from Table F.7a of IEC 60664-1 or clause 4 of IEC 60664-4, the clearances of supplementary insulation are not less than those specified for basic insulation		N/A
	If clearances for basic insulation are selected from Table F.7a of IEC 60664-1, the clearances of reinforced insulation dimensioned as specified in Table F.7a are to withstand 160 % of the withstand voltage required for basic insulation		N/A
	If clearances for basic insulation are selected from clause 4 of IEC 60664-4, the clearances of reinforced insulation are twice the value required for basic insulation		N/A
	If the secondary winding of a step-down transformer is earthed, or if there is an earthed screen between the primary and secondary windings, clearances of basic insulation on the secondary side not less than those specified in table 16, but using the next lower step for rated impulse voltage		N/A
	Circuits supplied with a voltage lower than rated voltage, clearances of functional insulation are based on the working voltage used as the rated voltage in table 15		N/A
29.2	Creepage distances not less than those appropriate for the working voltage, taking into account the material group and the pollution degree	(see appended table)	P
	:		
	Pollution degree 2 applies, unless		P
	- precautions taken to protect the insulation; pollution degree 1		N/A
	- insulation subjected to conductive pollution; pollution degree 3		P
	A force of 2 N is applied to bare conductors, other than heating elements		P
	A force of 30 N is applied to accessible surfaces		P

IEC 60335-2-40			
Clause	Requirement + Test	Result - Remark	Verdict
	In a double insulation system, the working voltage for both the basic and supplementary insulation is taken as the working voltage across the complete double insulation system		P
	Insulation located in airflow, pollution degree 3 unless (IEC 60335-2-40:2018)		P
	insulation enclosed or located so that unlikely to be exposed to pollution due to normal use (IEC 60335-2-40:2018)		N/A
29.2.1	Creepage distances of basic insulation not less than specified in table 17	(see appended table)	P
	However, if the working voltage is periodic and has a frequency exceeding 30 kHz, the creepage distances are also determined from table 2 of IEC 60664-4, these values being used if exceeding the values in table 17		N/A
	Except for pollution degree 1, corresponding creepage distance not less than the minimum specified for the clearance in table 16, if the clearance has been checked according to the test of clause 14		N/A
29.2.2	Creepage distances of supplementary insulation at least those specified for basic insulation in table 17, or	(see appended table)	P
	Table 2 of IEC 60664-4, as applicable		N/A
29.2.3	Creepage distances of reinforced insulation at least double those specified for basic insulation in table 17, or	(see appended table)	P
	Table 2 of IEC 60664-4, as applicable		N/A
29.2.4	Creepage distances of functional insulation not less than specified in table 18	(see appended table)	P
	However, if the working voltage is periodic and has a frequency exceeding 30 kHz, the creepage distances are also determined from table 2 of IEC 60664-4, these values being used if exceeding the values in table 18		N/A
	Creepage distances may be reduced if the appliance complies with clause 19 with the functional insulation short-circuited		N/A
29.3	Supplementary and reinforced insulation have adequate thickness, or a sufficient number of layers, to withstand the electrical stresses		P
	Compliance checked:		--
	- by measurement, in accordance with 29.3.1, or		P
	- by an electric strength test in accordance with 29.3.2, or		N/A

IEC 60335-2-40			
Clause	Requirement + Test	Result - Remark	Verdict
	- for insulation, other than single layer internal wiring insulation, by an assessment of the thermal quality of the material combined with an electric strength test, in accordance with 29.3.3, and		N/A
	for accessible parts of reinforced insulation consisting of a single layer, by measurement in accordance with 29.3.4, or		N/A
	- by an assessment of the thermal quality of the material according to 29.3.3 combined with an electric strength test in accordance with 23.5, for each single layer internal wiring insulation touching each other, or		N/A
	- as specified in subclause 6.3 of IEC 60664-4 for insulation that is subjected to any periodic voltage having a frequency exceeding 30 kHz		N/A
29.3.1	Supplementary insulation have a thickness of at least 1 mm		P
	Reinforced insulation have a thickness of at least 2 mm		P
29.3.2	Each layer of material withstand the electric strength test of 16.3 for supplementary insulation		N/A
	Supplementary insulation consist of at least 2 layers		N/A
	Reinforced insulation consist of at least 3 layers		N/A
29.3.3	The insulation is subjected to the dry heat test Bb of IEC 60068-2-2, followed by		N/A
	the electric strength test of 16.3		N/A
	If the temperature rise during the tests of clause 19 does not exceed the value specified in table 3, the test of IEC 60068-2-2 is not carried out		N/A
29.3.4	Thickness of accessible parts of reinforced insulation consisting of a single layer not less than specified in table 19		N/A
30	RESISTANCE TO HEAT AND FIRE		--
30.1	External parts of non-metallic material,		P
	parts supporting live parts, and		P
	parts of thermoplastic material providing supplementary or reinforced insulation		P
	sufficiently resistant to heat		P
	Ball-pressure test according to IEC 60695-10-2		P
	External parts tested at 40 °C plus the maximum temperature rise determined during the test of clause 11, or at 75 °C, whichever is the higher; temperature (°C)	(see appended table 30.1)	P

IEC 60335-2-40			
Clause	Requirement + Test	Result - Remark	Verdict
	Parts supporting live parts tested at 40 °C plus the maximum temperature rise determined during the test of clause 11, or at 125 °C, whichever is the higher; temperature (°C)	(see appended table 30.1)	P
	Parts of thermoplastic material providing supplementary or reinforced insulation tested at 25 °C plus the maximum temperature rise determined during clause 19, if higher; temperature (°C).....	(see appended table 30.1)	N/A
30.2	Parts of non-metallic material resistant to ignition and spread of fire		P
	This requirement does not apply to:		--
	parts having a mass not exceeding 0,5 g, provided the cumulative effect is unlikely to propagate flames that originate inside the appliance by propagating flames from one part to another, or		P
	decorative trims, knobs and other parts unlikely to be ignited or to propagate flames that originate inside the appliance		P
	Compliance checked by the test of 30.2.1, and in addition:		P
	- for attended appliances, 30.2.2 applies		N/A
	- for unattended appliances, 30.2.3 applies		P
	For appliances for remote operation, 30.2.3 applies		N/A
	For base material of printed circuit boards, 30.2.4 applies		P
30.2.1	Parts of non-metallic material subjected to the glow-wire test of IEC 60695-2-11 at 550 °C	(see appended table 30.2)	P
	However, test not carried out if the material is classified as having a glow-wire flammability index according to IEC 60695-2-12 of at least 550 °C, or		P
	the material is classified at least HB40 according to IEC 60695-11-10		N/A
	Parts for which the glow-wire test cannot be carried out need to meet the requirements in ISO 9772 for material classified HBF		N/A
30.2.3	Appliances operated while unattended, tested as specified in 30.2.3.1 and 30.2.3.2		P
	The tests are not applicable to conditions as specified		N/A
30.2.3.1	Parts of non-metallic material supporting connections carrying a current exceeding 0,2 A during normal operation, and		P
	parts of non-metallic material, other than small parts, within a distance of 3 mm,		P

IEC 60335-2-40			
Clause	Requirement + Test	Result - Remark	Verdict
	subjected to the glow-wire test of IEC 60695-2-11 with a test severity of 850 °C	(see appended table 30.2)	P
	Glow-wire applied to an interposed shielding material, if relevant		N/A
	The glow-wire test is not carried out on parts of material classified as having a glow-wire flammability index according to IEC 60695-2-12 of at least 850 °C		N/A
30.2.3.2	Parts of non-metallic material supporting connections, and		P
	parts of non-metallic material within a distance of 3 mm,		P
	subjected to the glow-wire test of IEC 60695-2-11 with appropriate severity level:	(see appended table 30.2)	P
	- 750 °C, for connections carrying a current exceeding 0,2 A during normal operation		P
	- 650 °C, for other connections		N/A
	Glow-wire applied to an interposed shielding material, if relevant		P
	However, the glow-wire test of 750 °C or 650 °C as appropriate, is not carried out on parts of material fulfilling both or either of the following classifications:		--
	- a glow-wire ignition temperature according to IEC 60695-2-13 of at least:		N/A
	- 775 °C, for connections carrying a current exceeding 0,2 A during normal operation		N/A
	- 675 °C, for other connections		N/A
	- a glow-wire flammability index according to IEC 60695-2-12 of at least:		N/A
	- 750 °C, for connections carrying a current exceeding 0,2 A during normal operation		N/A
	- 650 °C, for other connections		N/A
	The glow-wire test is also not carried out on small parts. These parts are to:		--
	- comprise material having a glow-wire ignition temperature of at least 775 °C or 675 °C as appropriate, or		N/A
	- comprise material having a glow-wire flammability index of at least 750 °C or 650 °C as appropriate, or		N/A
	- comply with the needle-flame test of annex E, or		N/A
	- comprise material classified as V-0 or V-1 according to IEC 60695-11-10		N/A

IEC 60335-2-40			
Clause	Requirement + Test	Result - Remark	Verdict
	The consequential needle-flame test of annex E applied to non-metallic parts that encroach within the vertical cylinder placed above the centre of the connection zone and on top of the non-metallic parts supporting current-carrying connections, and parts of non-metallic material within a distance of 3 mm of such connections if these parts are those:		--
	- parts that withstood the glow-wire test of IEC 60695-2-11 of 750 °C or 650 °C as appropriate, but produce a flame that persist longer than 2 s, or		P
	- parts that comprised material having a glow-wire flammability index of at least 750 °C or 650 °C as appropriate, or		N/A
	- small parts, that comprised material having a glow-wire flammability index of at least 750 °C or 650 °C as appropriate, or		N/A
	- small parts for which the needle-flame test of annex E was applied, or		P
	- small parts for which a material classification of V-0 or V-1 was applied		N/A
	However, the consequential needle-flame test is not carried out on non-metallic parts, including small parts, within the cylinder that are:		--
	- parts having a glow-wire ignition temperature of at least 775 °C or 675 °C as appropriate, or		N/A
	- parts comprising material classified as V-0 or V-1 according to IEC 60695-11-10, or		N/A
	- parts shielded by a flame barrier that meets the needle-flame test of annex E or that comprises material classified as V-0 or V-1 according to IEC 60695-11-10		N/A
30.2.4	Base material of printed circuit boards subjected to the needle-flame test of annex E	(see appended table 30.2/30.2.4)	P
	Test not applicable to conditions as specified		N/A
31	RESISTANCE TO RUSTING		--
	Relevant ferrous parts adequately protected against rusting		P
	Tests specified in part 2 when necessary		P
	Salt mist test of IEC 60068-2-52, severity 2 (IEC 60335-2-40:2018)		P
	Before test, coatings are scratched by means of a harden steel pin as specified (IEC 60335-2-40:2018)		P
	Five scratches made at least 5 mm apart and at least 5 mm from the edges (IEC 60335-2-40:2018)		P

IEC 60335-2-40			
Clause	Requirement + Test	Result - Remark	Verdict
	Appliance not deteriorated to such an extent that compliance with clause 8 and 27 is impaired (IEC 60335-2-40:2018)		P
	Coating not be broken and not loosened from the metal surface (IEC 60335-2-40:2018)		P
32	RADIATION, TOXICITY AND SIMILAR HAZARDS		--
	Appliance does not emit harmful radiation or present a toxic or similar hazard due to their operation in normal use		P
	Compliance is checked by the limits or tests specified in part 2, if relevant		P
32.101	UV-C irradiance test (IEC 60335-2-40:2018)		--
32.101.1	For the occupied space outside the unit, a test be performed to determine the UV-C spectral irradiance. (IEC 60335-2-40:2018)		N/A
	Emissions from the equipment not exceed a UV-C spectral irradiance limit of 0,2 $\mu\text{W}/\text{cm}^2$ (IEC 60335-2-40:2018)		N/A
32.101.2	For areas inside the unit that are accessible for anticipated user maintenance and are not equipped with the interlock required by Subclause 22.128, there be no UV-C spectral irradiance greater than 1,7 $\mu\text{W}/\text{cm}^2$ (IEC 60335-2-40:2018)		N/A
	UV-C spectral irradiance is measured at any point of accessibility required for user maintenance. (IEC 60335-2-40:2018)		N/A
	When determining user accessibility, consideration should be given to the actual degree of exposure that the user would experience in performing his duties. (IEC 60335-2-40:2018)		N/A
	Compliance is determined by measuring the UV-C irradiance per IEC 62471:2006, Clause 5 and Annex B. (IEC 60335-2-40:2018)		N/A
32.101.3	UV-C irradiance is measured at the location in Table 101 (IEC 60335-2-40:2018)		N/A
32.101.4	When conducting UV-C irradiance tests: (IEC 60335-2-40:2018)		--
	- the UV-C irradiance measurements are conducted with a scanning spectroradiometer, or a narrow band range radiometer; (IEC 60335-2-40:2018)		N/A
	- all panels and components are positioned or adjusted in the most severe position (IEC 60335-2-40:2018)		N/A
	- removable air filters are removed; (IEC 60335-2-40:2018)		N/A

IEC 60335-2-40			
Clause	Requirement + Test	Result - Remark	Verdict
	- measurements are made at the worst case location and angle of incidence; (IEC 60335-2-40:2018)		N/A
	- the minimum specified duct and configuration, including any duct liners, specified by the manufacturer be in place and the measurements taken at the opening at the end of the duct. (IEC 60335-2-40:2018)+		N/A
A	ANNEX A (INFORMATIVE) ROUTINE TESTS		--
	Description of routine tests to be carried out by the manufacturer		N/A
B	ANNEX B (NORMATIVE) APPLIANCES POWERED BY RECHARGEABLE BATTERIES THAT ARE RECHARGED IN THE APPLIANCE		--
	The following modifications to this standard are applicable for appliances powered by batteries that are recharged in the appliance		N/A
	Three forms of construction covered:		--
	a) Appliance supplied directly from the supply mains or a renewable energy source, the battery charging circuitry and other supply unit circuitry incorporated within the appliance		N/A
	b) The part of the appliance incorporating the battery is supplied from the supply mains or a renewable energy source, via a detachable supply unit. The battery charging circuitry is incorporated within the part of the appliance containing the battery		N/A
	c) The part of the appliance incorporating the battery is supplied from the supply mains or a renewable energy source, via a detachable supply unit. The battery charging circuitry is incorporated within the detachable supply unit		N/A
3.1.9	Appliance operated under the following conditions:		--
	- the appliance, supplied by its fully charged battery, operated as specified in relevant part 2		N/A
	- the battery is charged, the battery being initially discharged to such an extent that the appliance cannot operate		N/A
	- if possible, the appliance is supplied from the supply mains through its battery charger, the battery being initially discharged to such an extent that the appliance cannot operate. The appliance is operated as specified in relevant part 2		N/A

IEC 60335-2-40			
Clause	Requirement + Test	Result - Remark	Verdict
	- if the appliance incorporates inductive coupling between two parts that are detachable from each other, the appliance is supplied from the supply mains with the detachable part removed		N/A
3.6.2	Part to be removed in order to discard the battery is not considered to be detachable		N/A
5.B.101	Appliances supplied from the supply mains tested as specified for motor-operated appliances		N/A
7.1	Battery compartment for batteries intended to be replaced by the user, marked with battery voltage (V) and polarity of the terminals		N/A
	The positive terminal indicated by symbol IEC 60417-5005 and the negative terminal by symbol IEC 60417-5006		N/A
	Appliances intending to be supplied from a detachable supply unit marked with symbol IEC 60417-6181 and its type reference along with symbol ISO 7000-0790 (2004-01), or		N/A
	use only with <model designation> supply unit ... :		N/A
7.6	Additional symbols		N/A
7.12	The instructions give information regarding charging		N/A
	Instructions for appliances incorporating batteries intended to be replaced by the user include required information		N/A
	Instructions for appliances containing non user-replaceable batteries state the substance of the following:		--
	This appliance contains batteries that are only replaceable by skilled persons		N/A
	Instructions for appliances containing non-replaceable batteries shall state the substance of the following:		--
	This appliance contains batteries that are non-replaceable		N/A
	For appliances intending to be supplied from a detachable supply unit for the purposes of recharging the battery, the type reference of the detachable supply unit is stated along with the following:		--
	WARNING: For the purposes of recharging the battery, only use the detachable supply unit provided with this appliance		N/A
	If the symbol for detachable supply unit is used, its meaning is explained		N/A
7.15	Markings placed on the part of the appliance connected to the supply mains		N/A
	The type reference of the detachable supply unit is placed in close proximity to the symbol		N/A

IEC 60335-2-40			
Clause	Requirement + Test	Result - Remark	Verdict
8.2	Appliances having batteries that according to the instruction may be replaced by the user need only have basic insulation between live parts and the inner surface of the battery compartment		N/A
	If the appliance can be operated without batteries, double or reinforced insulation required		N/A
11.7	The battery is charged for the period stated in the instructions or 24 h..... :		N/A
11.8	Temperature rise of the battery surface does not exceed the limit in the battery manufacturer's specification; measured (K); limit (K) :		N/A
	If no limit specified, the temperature rise does not exceed 20 K; measured (K) :		N/A
19.1	Appliances subjected to tests of 19.B.101, 19.B.102 and 19.B.103		N/A
19.10	Not applicable		N/A
19.B.101	Appliances supplied at rated voltage for 168 h, the battery being continually charged		N/A
19.B.102	For appliances having batteries that can be removed without the aid of a tool, short-circuit of the terminals of the battery, the battery being fully charged,		N/A
19.B.103	Appliances having batteries replaceable by the user supplied at rated voltage under normal operation with the battery removed or in any position allowed by the construction		N/A
19.13	The battery does not rupture or ignite		N/A
21.B.101	Appliances having pins for insertion into socket-outlets have adequate mechanical strength		N/A
	Part of the appliance incorporating the pins subjected to the free fall test, procedure 2, of IEC 60068-2-31, the number of falls being:		--
	- 100, if the mass of the part does not exceed 250 g (g)..... :		N/A
	- 50, if the mass of the part exceeds 250 g..... :		N/A
	After the test, the requirements of 8.1, 15.1.1, 16.3 and clause 29 are met		N/A
22.3	Appliances having pins for insertion into socket-outlets tested as fully assembled as possible		N/A
25.13	An additional lining or bushing not required for interconnection cords in class III appliances or class III constructions operating at safety extra-low voltage not containing live parts		N/A
30.2	For parts of the appliance connected to the supply mains during the charging period, 30.2.3 applies		N/A

IEC 60335-2-40			
Clause	Requirement + Test	Result - Remark	Verdict
	For other parts, 30.2.2 applies		N/A
C	ANNEX C (NORMATIVE) AGEING TEST ON MOTORS		--
	Tests, as described, carried out when doubt with regard to the temperature classification of the insulation of a motor winding		N/A
	Test conditions as specified		N/A
E	ANNEX E (NORMATIVE) NEEDLE-FLAME TEST		--
	Needle-flame test carried out in accordance with IEC 60695-11-5, with the following modifications:		--
7	Severities		--
	The duration of application of the test flame is 30 s ± 1 s		P
9	Test procedure		--
9.1	The specimen so arranged that the flame can be applied to a vertical or horizontal edge as shown in the examples of figure 1		P
9.2	The first paragraph does not apply		P
	If possible, the flame is applied at least 10 mm from a corner		P
9.3	The test is carried out on one specimen		P
	If the specimen does not withstand the test, the test may be repeated on two additional specimens, both withstanding the test		N/A
11	Evaluation of test results		—
	The duration of burning not exceeding 30 s		P
	However, for printed circuit boards, the duration of burning not exceeding 15 s		P
F	ANNEX F (NORMATIVE) CAPACITORS		—
	Capacitors likely to be permanently subjected to the supply voltage, and used for radio interference suppression or voltage dividing, comply with the following clauses of IEC 60384-14, with the following modifications:		—
1.5	Terms and definitions		—
1.5.3	Class X capacitors tested according to subclass X2		N/A
1.5.4	This subclause is applicable		N/A
1.6	Marking		—
	Items a) and b) are applicable		N/A
3.4	Approval testing		—
3.4.3.2	Table 3 is applicable as described		N/A

IEC 60335-2-40			
Clause	Requirement + Test	Result - Remark	Verdict
4.1	Visual examination and check of dimensions		—
	This subclause is applicable		N/A
4.2	Electrical tests		—
4.2.1	This subclause is applicable		N/A
4.2.5	This subclause is applicable		N/A
4.2.5.2	Only table 11 is applicable		N/A
	Values for test A apply		N/A
	However, for capacitors in heating appliances the values for test B or C apply		N/A
4.12	Damp heat, steady state		—
	This subclause is applicable		N/A
	Only insulation resistance and voltage proof are checked		N/A
4.13	Impulse voltage		—
	This subclause is applicable		N/A
4.14	Endurance		—
	Subclauses 4.14.1, 4.14.3, 4.14.4 and 4.14.7 are applicable		N/A
4.14.7	Only insulation resistance and voltage proof are checked		N/A
	No visible damage		N/A
4.17	Passive flammability test		—
	This subclause is applicable		N/A
4.18	Active flammability test		—
	This subclause is applicable		N/A
G	ANNEX G (NORMATIVE) SAFETY ISOLATING TRANSFORMERS		—
	The following modifications to this standard are applicable for safety isolating transformers:		—
7	Marking and instructions		—
7.1	Transformers for specific use marked with:		—
	- name, trademark or identification mark of the manufacturer or responsible vendor		N/A
	- model or type reference		N/A
17	Overload protection of transformers and associated circuits		—
	Fail-safe transformers comply with subclause 15.5 of IEC 61558-1		N/A
22	Construction		—

IEC 60335-2-40			
Clause	Requirement + Test	Result - Remark	Verdict
	Subclauses 19.1 and 19.1.2 of IEC 61558-2-6 are applicable		N/A
29	Clearances, creepage distances and solid insulation		—
29.1, 29.2, 29.3	The distances specified in items 2a, 2c and 3 in table 13 of IEC 61558-1 apply		N/A
	For insulated winding wires complying with subclause 19.12.3 of IEC 61558-1 there are no requirements for clearances or creepage distances		N/A
	For windings providing reinforced insulation, the distance specified in item 2c of table 13 of IEC 61558-1 is not assessed		N/A
	For safety isolating transformers subjected to periodic voltages with a frequency exceeding 30 kHz, the clearances, creepage distances and solid insulation values specified in IEC 60664-4 are applicable, if greater than the values specified in items 2a, 2c and 3 in table 13 of IEC 61558-1		N/A
H	ANNEX H (NORMATIVE) SWITCHES		—
	Switches comply with the following clauses of IEC 61058-1, as modified below:		—
	The tests of IEC 61058-1 carried out under the conditions occurring in the appliance		N/A
	Before being tested, switches are operated 20 times without load		N/A
8	Marking and documentation		—
	Switches are not required to be marked		N/A
	However, a switch that can be tested separately from the appliance marked with the manufacturer's name or trade mark and the type reference		N/A
13	Mechanism		—
	The tests may be carried out on a separate sample		N/A
15	Insulation resistance and dielectric strength		—
15.1	Not applicable		N/A
15.2	Not applicable		N/A
15.3	Applicable for full disconnection and micro-disconnection		N/A
17	Endurance		—
	Compliance is checked on three separate appliances or switches		N/A
	For 17.2.4.4, the number of cycles declared according to 7.1.4 is 10 000, unless		N/A
	otherwise specified in 24.1.3 of the relevant part 2 of IEC 60335		N/A

IEC 60335-2-40			
Clause	Requirement + Test	Result - Remark	Verdict
	Switches for operation under no load and which can be operated only by a tool, and		N/A
	switches operated by hand that are interlocked so that they cannot be operated under load,		N/A
	are not subjected to the tests		N/A
	However, switches without this interlock are subjected to the test of 17.2.4.4 for 100 cycles of operation		N/A
	Subclauses 17.2.2 and 17.2.5.2 not applicable		N/A
	The ambient temperature during the test is that occurring in the appliance during the test of clause 11 in IEC 60335-1		N/A
	The temperature rise of the terminals not more than 30 K above the temperature rise measured in clause 11 of IEC 60335-1 (K).....:		N/A
20	Clearances, creepage distances, solid insulation and coatings of rigid printed board assemblies		—
	Clause 20 is applicable to clearances across full disconnection and micro-disconnection		N/A
	It is also applicable to creepage distances for functional insulation, across full disconnection and micro-disconnection, as stated in Table 24		N/A
J	ANNEX J (NORMATIVE) COATED PRINTED CIRCUIT BOARDS		—
	Testing of protective coatings of printed circuit boards carried out in accordance with IEC 60664-3 with the following modifications:		—
5.7	Conditioning of the test specimens		—
	When production samples are used, three samples of the printed circuit board are tested		N/A
5.7.1	Cold		—
	The test is carried out at -25 °C		N/A
5.7.3	Rapid change of temperature		—
	Severity 1 is specified		N/A
5.9	Additional tests		—
	This subclause is not applicable		N/A
K	ANNEX K (NORMATIVE) OVERVOLTAGE CATEGORIES		—
	The information on overvoltage categories is extracted from IEC 60664-1		P
	Overvoltage category is a numeral defining a transient overvoltage condition		P

IEC 60335-2-40			
Clause	Requirement + Test	Result - Remark	Verdict
	Equipment of overvoltage category IV is for use at the origin of the installation		N/A
	Equipment of overvoltage category III is equipment in fixed installations and for cases where the reliability and the availability of the equipment is subject to special requirements		N/A
	Equipment of overvoltage category II is energy consuming equipment to be supplied from the fixed installation		P
	If such equipment is subjected to special requirements with regard to reliability and availability, overvoltage category III applies		N/A
	Equipment of overvoltage category I is equipment for connection to circuits in which measures are taken to limit transient overvoltages to an appropriate low level		N/A
L	ANNEX L (INFORMATIVE) GUIDANCE FOR THE MEASUREMENT OF CLEARANCES AND CREEPAGE DISTANCES		—
	Information for the determination of clearances and creepage distances		N/A
M	ANNEX M (NORMATIVE) POLLUTION DEGREE		—
	The information on pollution degrees is extracted from IEC 60664-1		P
	Pollution		—
	The microenvironment determines the effect of pollution on the insulation, taking into account the macroenvironment		P
	Means may be provided to reduce pollution at the insulation by effective enclosures or similar		P
	Minimum clearances specified where pollution may be present in the microenvironment		P
	Degrees of pollution in the microenvironment		—
	For evaluating creepage distances, the following degrees of pollution in the microenvironment are established:		—
	- pollution degree 1: no pollution or only dry, non-conductive pollution occurs. The pollution has no influence		N/A
	- pollution degree 2: only non-conductive pollution occurs, except that occasionally a temporary conductivity caused by condensation is to be expected		P

IEC 60335-2-40			
Clause	Requirement + Test	Result - Remark	Verdict
	- pollution degree 3: conductive pollution occurs or dry non-conductive pollution occurs that becomes conductive due to condensation that is to be expected		P
	- pollution degree 4: the pollution generates persistent conductivity caused by conductive dust or by rain or snow		N/A
N	ANNEX N (NORMATIVE) PROOF TRACKING TEST		—
	The proof tracking test is carried out in accordance with IEC 60112 with the following modifications:		--
7	Test apparatus		—
7.3	Test solutions		—
	Test solution A is used		P
10	Determination of proof tracking index (PTI)		—
10.1	Procedure		—
	The proof voltage is 100 V, 175 V, 400 V or 600 V:	175V	P
	The test is carried out on five specimens		P
	In case of doubt, additional test with proof voltage reduced by 25 V, the number of drops increased to 100		N/A
10.2	Report		—
	The report states if the PTI value was based on a test using 100 drops with a test voltage of (PTI-25) V		N/A
O	ANNEX O (INFORMATIVE) SELECTION AND SEQUENCE OF THE TESTS OF clause 30		—
	Description of tests for determination of resistance to heat and fire		P
P	ANNEX P (INFORMATIVE) GUIDANCE FOR THE APPLICATION OF THIS STANDARD TO APPLIANCES USED IN TROPICAL CLIMATES		—
	Modifications applicable for class 0 and 0I appliances having a rated voltage exceeding 150 V, intended to be used in countries having a tropical climate and that are marked with symbol IEC 60417-6332		—
	Modifications may also be applied to class 1 appliances having a rated voltage exceeding 150 V, intended to be used in countries having a tropical climate and that are marked with symbol IEC 60417-6332, if liable to be connected to a supply mains that excludes the protective earthing conductor		—
5.7	The ambient temperature for the tests of clauses 11 and 13 is 40 +3/0 °C		N/A
7.1	The appliance marked with symbol IEC 60417-6332		N/A

IEC 60335-2-40			
Clause	Requirement + Test	Result - Remark	Verdict
7.12	The instructions state that the appliance is to be supplied through a residual current device (RCD) having a rated residual operating current not exceeding 30 mA		N/A
	The instructions state that the appliance is considered to be suitable for use in countries having a tropical climate, but may also be used in other countries		N/A
	If symbol IEC 60417-6332 is used, its meaning is explained		N/A
11.8	The values of Table 3 are reduced by 15 K		N/A
13.2	The leakage current for class I appliances not exceeding 0,5 mA		N/A
15.3	The value of t is 37 °C		N/A
16.2	The leakage current for class I appliances not exceeding 0,5 mA (mA):		N/A
19.13	The leakage current test of 16.2 is applied in addition to the electric strength test of 16.3		N/A
Q	ANNEX Q (INFORMATIVE) SEQUENCE OF TESTS FOR THE EVALUATION OF ELECTRONIC CIRCUITS		—
	Description of tests for appliances incorporating electronic circuits		—
R	ANNEX R (NORMATIVE) SOFTWARE EVALUATION		—
	Programmable electronic circuits requiring software incorporating measures to control the fault/error conditions specified in table R.1 or R.2 validated in accordance with the requirements of this annex		N/A
R.1	Programmable electronic circuits using software		—
	Programmable electronic circuits requiring software incorporating measures to control the fault/error conditions specified in table R.1 or R.2 constructed so that the software does not impair compliance with the requirements of this standard		N/A
R.2	Requirements for the architecture		—
	Programmable electronic circuits requiring software incorporating measures to control the fault/error conditions specified in table R.1 or R.2 use measures to control and avoid software-related faults/errors in safety-related data and safety-related segments of the software		N/A
R.2.1.1	Programmable electronic circuits requiring software incorporating measures to control the fault/error conditions specified in table R.2 have one of the following structures:		—
	- single channel with periodic self-test and monitoring		N/A

IEC 60335-2-40			
Clause	Requirement + Test	Result - Remark	Verdict
	- dual channel (homogenous) with comparison		N/A
	- dual channel (diverse) with comparison		N/A
	Programmable electronic circuits requiring software incorporating measures to control the fault/error conditions specified in table R.1 have one of the following structures:		—
	- single channel with functional test		N/A
	- single channel with periodic self-test		N/A
	- dual channel without comparison		N/A
R.2.2	Measures to control faults/errors		—
R.2.2.1	When redundant memory with comparison is provided on two areas of the same component, the data in one area is stored in a different format from that in the other area		N/A
R.2.2.2	Programmable electronic circuits with functions requiring software incorporating measures to control the fault/error conditions specified in table R.2 and that use dual channel structures with comparison, have additional fault/error detection means for any fault/errors not detected by the comparison		N/A
R.2.2.3	For programmable electronic circuits with functions requiring software incorporating measures to control the fault/error conditions specified in table R.1 or R.2, means are provided for the recognition and control of errors in transmissions to external safety-related data paths		N/A
R.2.2.4	For programmable electronic circuits with functions requiring software incorporating measures to control the fault/error conditions specified in table R.1 or R.2, the programmable electronic circuits incorporate measures to address the fault/errors in safety-related segments and data indicated in table R.1 and R.2 as appropriate		N/A
R.2.2.5	For programmable electronic circuits with functions requiring software incorporating measures to control the fault/error conditions specified in table R.1 or R.2, detection of a fault/error occur before compliance with clause 19 is impaired		N/A
R.2.2.6	The software is referenced to relevant parts of the operating sequence and the associated hardware functions		N/A
R.2.2.7	Labels used for memory locations are unique		N/A
R.2.2.8	The software is protected from user alteration of safety-related segments and data		N/A
R.2.2.9	Software and safety-related hardware under its control is initialized and terminates before compliance with clause 19 is impaired		N/A

IEC 60335-2-40			
Clause	Requirement + Test	Result - Remark	Verdict
R.3	Measures to avoid errors		—
R.3.1	General		—
	For programmable electronic circuits with functions requiring software incorporating measures to control the fault/error conditions specified in table R.1 or R.2, the following measures to avoid systematic fault in the software are applied		—
	Software that incorporates measures used to control the fault/error conditions specified in table R.2 is inherently acceptable for software required to control the fault/error conditions specified in table R.1		N/A
R.3.2	Specification		—
R.3.2.1	Software safety requirements:	Software Id:	N/A
	The specification of the software safety requirements includes the descriptions listed		N/A
R.3.2.2	Software architecture		—
R.3.2.2.1	The specification of the software architecture includes the aspects listed - techniques and measures to control software faults/errors (refer to R.2.2); - interactions between hardware and software; - partitioning into modules and their allocation to the specified safety functions; - hierarchy and call structure of the modules (control flow); - interrupt handling; - data flow and restrictions on data access; - architecture and storage of data; - time-based dependencies of sequences and data	Document ref. No:	N/A
R.3.2.2.2	The architecture specification is validated against the specification of the software safety requirements by static analysis		N/A
R.3.2.3	Module design and coding		—
R.3.2.3.1	Based on the architecture design, software is suitably refined into modules		N/A
	Software module design and coding is implemented in a way that is traceable to the software architecture and requirements		N/A
R.3.2.3.2	Software code is structured		—
R.3.2.3.3	Coded software is validated against the module specification by static analysis		N/A
	The module specification is validated against the architecture specification by static analysis		N/A
R.3.3.3	Software validation		—

IEC 60335-2-40			
Clause	Requirement + Test	Result - Remark	Verdict
	The software is validated with reference to the requirements of the software safety requirements specification		N/A
	Compliance is checked by simulation of:		—
	- input signals present during normal operation		N/A
	- anticipated occurrences		N/A
	- undesired conditions requiring system action		N/A

IEC 60335-2-40			
Clause	Requirement + Test	Result - Remark	Verdict

TABLE R.1 e – GENERAL FAULT/ERROR CONDITIONS						
Component ^a	Fault/error	Acceptable measures ^{b, c}	Definitions	Document reference for applied measure	Document reference for applied test	Verdict
1 CPU						N/A
1.1 Registers	Stuck at	Functional test, or periodic self-test using either: <ul style="list-style-type: none"> - static memory test, or - word protection with single bit redundancy 	H.2.16.5 H.2.16.6 H.2.19.6 H.2.19.8.2			N/A
1.2 VOID						N/A
1.3 Programme counter	Stuck at	Functional test, or Periodic self-test, or Independent time-slot monitoring, or Logical monitoring of the programme sequence	H.2.16.5 H.2.16.6 H.2.18.10.4 H.2.18.10.2			N/A
2 Interrupt handling and execution	No interrupt or too frequent interrupt	Functional test, or time-slot monitoring	H.2.16.5 H.2.18.10.4			N/A
3 Clock	Wrong frequency (for quartz synchronized clock: harmonics/sub-harmonics only)	Frequency monitoring, or time slot monitoring	H.2.18.10.1 H.2.18.10.4			N/A
4. Memory						N/A
4.1 Invariable memory	All single bit faults	Periodic modified checksum, or multiple checksum, or word protection with single bit redundancy	H.2.19.3.1 H.2.19.3.2 H.2.19.8.2			N/A
4.2 Variable memory	DC fault	Periodic static memory test, or word protection with single bit redundancy	H.2.19.6 H.2.19.8.2			N/A

IEC 60335-2-40						
Clause	Requirement + Test		Result - Remark			Verdict
4.3 Addressing (relevant to variable and invariable memory)	Stuck at	Word protection with single bit redundancy including the address	H.2.19.8.2			N/A
5 Internal data path	Stuck at	Word protection with single bit redundancy	H.2.19.8.2			N/A
5.1 VOID						N/A
5.2 Addressing	Wrong address	Word protection with single bit redundancy including the address	H.2.19.8.2			N/A
6 External communicati on	Hamming distance 3	Word protection with multi-bit redundancy, or CRC – single work, or Transfer redundancy, or Protocol test	H.2.19.8.1 H.2.19.4.1 H.2.18.2.2 H.2.18.14			N/A
6.1 VOID						N/A
6.2 VOID						N/A
6.3 Timing	Wrong point in time Wrong sequence	Time-slot monitoring, or scheduled transmission Time-slot and logical monitoring, or comparison of redundant communication channels by either: - reciprocal comparison - independent hardware comparator Logical monitoring, or time-slot monitoring, or Scheduled transmission	H.2.18.10.4 H.2.18.18 H.2.18.10.3 H.2.18.15 H.2.18.3 H.2.18.10.2 H.2.18.10.4 H.2.18.18			N/A
7 Input/output periphery	Fault conditions specified in 19.11.2	Plausibility check	H.2.18.13			N/A
7.1 VOID						N/A
7.2 Analog I/O 7.2.1 A/D and D/A- converter	Fault conditions specified in 19.11.2	Plausibility check	H.2.18.13			N/A

IEC 60335-2-40			
Clause	Requirement + Test	Result - Remark	Verdict

7.2.2 Analog multiplexer	Wrong addressing	Plausibility check	H.2.18.13			N/A
8 VOID						N/A
9 Custom chips ^d e.g. ASIC, GAL, gate array	Any output outside the static and dynamic functional specification	Periodic self-test	H.2.16.6			N/A

NOTE A Stuck-at fault model denotes a fault model representing an open circuit or a non-varying signal level. A DC fault model denotes a stuck-at fault model incorporating short circuit between signal lines.

- a) For fault/error assessment, some components are divided into their sub-functions.
- b) For each sub-function in the table, the Table R.2 measure will cover the software fault/error.
- c) Where more than one measure is given for a sub-function, these are alternatives.
- d) To be divided as necessary by the manufacturer into sub-functions.
- e) Table R.1 is applied according to the requirements of R.1 to R.2.2.9 inclusive.

S	ANNEX S (NORMATIVE) BATTERY OPERATED APPLIANCES POWERED BY BATTERIES THAT ARE NON-RECHARGEABLE OR NOT RECHARGED IN THE APPLIANCE		—
	The following modifications to this standard are applicable for battery-operated appliances where the batteries are either non-rechargeable (primary batteries), or		N/A
	rechargeable batteries (secondary batteries) that are not recharged in the appliance		N/A
5.8.1	If the supply terminals for the connection of the battery have no indication of polarity, the more unfavourable polarity is applied		N/A
5.S.101	Appliances intended for use with a battery box are tested with the battery box supplied with the appliance or with the battery box recommended in the instructions		N/A
5.S.102	Appliances are tested as motor-operated appliances.		N/A
7.1	Appliances marked with the battery voltage (V) and the polarity of the terminals, unless.....:		N/A
	the polarity is irrelevant		N/A
	Appliances also marked with:		—
	- name, trade mark or identification mark of the manufacturer or responsible vendor		N/A
	- model or type reference		N/A
	- IP number according to degree of protection against ingress of water, other than IPX0		N/A
	- type reference of battery or batteries		N/A

TRF No. IEC60335_2_400

1285/5 Prachachuen Rd., Wongsawang, Bangsue, Bangkok 10800 THAILAND

Tel : +66 2 765 2888 Fax : +66 2 765 2889

www.intertek.com

IEC 60335-2-40			
Clause	Requirement + Test	Result - Remark	Verdict
	If relevant, the positive terminal is indicated by the symbol IEC 60417-5005 and the negative terminal by the symbol IEC 60417-5006		N/A
	If appliances use more than one battery, they are marked to indicate correct polarity connection of the batteries		N/A
7.6	Additional symbols		N/A
7.12	The instructions contain the following, as applicable:		—
	- the types of batteries that may be used		N/A
	- how to remove and insert the batteries		N/A
	- non-rechargeable batteries are not to be recharged		N/A
	- rechargeable batteries are to be removed from the appliance before being charged		N/A
	- different types of batteries or new and used batteries are not to be mixed		N/A
	- batteries are to be inserted with the correct polarity		N/A
	- exhausted batteries are to be removed from the appliance and safely disposed of		N/A
	- if the appliance is to be stored unused for a long period, the batteries are removed		N/A
	- the supply terminals are not to be short-circuited		N/A
11.5	Appliances are supplied with the most unfavourable supply voltage between		—
	- 0,55 and 1,0 times the battery voltage, if the appliance can be used with non-rechargeable batteries		N/A
	- 0,75 and 1,0 times battery voltage, if the appliance is designed for use with rechargeable batteries only		N/A
	The values specified in Table S.101 for the internal resistance per cell of the battery is taken into account		N/A
19.1	The tests are carried out with the battery fully charged unless otherwise specified		N/A
19.13	The battery does not rupture or ignite		N/A
19.S.101	Appliances are supplied with the voltage specified in 11.5. The supply terminals having an indication of polarity are connected to the opposite polarity, unless		N/A
	such a connection is unlikely to occur due to the construction of the appliance		N/A

IEC 60335-2-40			
Clause	Requirement + Test	Result - Remark	Verdict
19.S.102	For appliances with provision for multiple batteries, one or more of the batteries are reversed and the appliance is operated, if reversal of batteries is allowed by the construction		N/A
25.5	The flexible leads or flexible cord used to connect an external battery or battery box in is connected to the appliance by a type X attachment		N/A
25.13	This requirement is not applicable to the flexible leads or flexible cord connecting external batteries or a battery box with an appliance		N/A
25.S.101	Appliances have suitable means for connection of the battery. If the type of battery is marked on the appliance, the means of connection is suitable for this type of battery		N/A
26.5	Terminal devices in an appliance for the connection of the flexible leads or flexible cord connecting an external battery or battery box are so located or shielded that there is no risk of accidental connection between supply terminals		N/A
30.2.3.2	There is no battery in the area of the vertical cylinder used for the consequential needle flame test, unless		N/A
	the battery is shielded by a barrier that meets the needle flame test of annex E, or		N/A
	that comprises material classified as V-0 or V-1 according to IEC 60695-11-10		N/A
T	ANNEX T (NORMATIVE) UV-C RADIATION EFFECT ON NON-METALLIC MATERIALS		—
	Requirements for non-metallic materials subject to direct or reflected UV-C radiation exposure and whose mechanical and electrical properties are relied upon for compliance with the		N/A
	Does not apply to glass, ceramic and similar materials		N/A
	Tested as specified in ISO 4892-1 and ISO 4892-2, with the following modifications:		—
	Modifications to ISO 4892-1:		—
5.1.6	The UV-C emitter is a low pressure mercury lamp with a quartz envelope having a continuous spectral irradiance of 10 W/m ² at 254 nm		N/A
	Subclause 5.1.6.1 and Table 1 are not applicable		N/A
5.2.4	The black-panel temperature be 63 °C +/- 3 °C		N/A
5.3.1	Humidification of the chamber air is specified in part 2 when necessary		N/A
9	This clause is not applicable		N/A
	Modifications to ISO 4892-2:		—

IEC 60335-2-40			
Clause	Requirement + Test	Result - Remark	Verdict
7.1	At least three test specimens are tested		N/A
	Ten samples of internal wiring is tested		N/A
7.2	The specimens are attached to the specimen holders such that they are not subject to any stress		N/A
7.3	Apparatus prepared as specified		N/A
	The test specimens and, if used, the irradiance-measuring instrument are exposed for 1 000 h		N/A
7.4	If used, a radiometer is mounted and calibrated such that it measures the irradiance at the exposed surface of the test specimen		N/A
7.5	Material properties and test methods for parts providing mechanical support or impact resistance as specified in Table T.1		N/A
	Material properties and test method for electrical insulation of internal wiring as specified in Table T.2		N/A
8	This clause is not applicable		N/A
AA	ANNEX AA (INFORMATIVE) (IEC 60335-2-40:2018) EXAMPLES FOR OPERATING TEMPERATURES OF THE APPLIANCE		—
	Table AA.1 Examples for operating temperatures of the appliance		N/A
BB	ANNEX BB (NORMATIVE) (IEC 60335-2-40:2018) SELECTED INFORMATION ABOUT REFRIGERANTS		—
	Table BB.1 Selected information about refrigerants		N/A
CC	ANNEX CC (INFORMATIVE) (IEC 60335-2-40:2018) TRANSPORTATION, MARKING AND STORAGE FOR UNITS THAT EMPLOY FLAMMABLE REFRIGERANTS		—
DD	ANNEX DD (NORMATIVE) (IEC 60335-2-40:2018) REQUIREMENTS FOR OPERATION, SERVICE AND INSTALLATION MANUALS OF APPLIANCES USING FLAMMABLE REFRIGERANTS		—
DD.1	General		—
	Each service manual shall include requirements of clauses according to Table DD.1. Different manuals can be combined into one manual.		P
DD.2	Symbols		—
	The symbols referred to in 7.6 (without colours is permitted) and the information of the warning marking shall be provided as follows:		P

IEC 60335-2-40			
Clause	Requirement + Test	Result - Remark	Verdict
	WARNING Do not use means to accelerate the defrosting process or to clean, other than those recommended by the manufacturer.		P
	The appliance shall be stored in a room without continuously operating ignition sources (for example: open flames, an operating gas appliance or an operating electric heater).		P
	Do not pierce or burn.		P
	Be aware that refrigerants may not contain an odour.		P
	The manufacturer may provide other suitable examples or may provide additional information about the refrigerant odour.		P
DD.3	Information in manual		—
DD.3.1	General		—
	The following information shall be specified in the manual where the information is needed for the function of the manual and as applicable to the appliance:		P
	- information for spaces where refrigerant pipes are allowed, including statements		P
	that the installation of pipe-work shall be kept to a minimum;		P
	that pipe-work shall be protected from physical damage and, in the case of flammable refrigerants, shall not be installed in an unventilated space, if that space is smaller than Amin in Annex GG, except for A2L refrigerants where the installed pipes comply with 22.116. In case of field charge, the effect on refrigerant charge caused by the different pipe length has to be quantified;		N/A
	that compliance with national gas regulations shall be observed;		P
	that mechanical connections made in accordance with 22.118 shall be accessible for maintenance purposes;		N/A
	that, for appliances containing flammable refrigerants, the minimum floor area of the room shall be mentioned in the form of a table or a single figure without reference to a formula;		N/A
	- the maximum refrigerant charge (m_{max});		P
	- instructions how to determine the additional refrigerant charge and how to complete the refrigerant charge on the label provided by the manufacturer considering the requirements in 7.107;		P

IEC 60335-2-40			
Clause	Requirement + Test	Result - Remark	Verdict
	- the minimum rated airflow, if required by Annex GG;		N/A
	- information for handling, installation, cleaning, servicing and disposal of refrigerant;		P
	-for appliances using flammable refrigerants, instructions shall include the minimum installed height hinst (when required to calculate Amin), refrigerant charge mc and minimum room area of the space Amin or a minimum room area of conditioned space TAmin where applicable. Additional minimum room area data may be provided based on other installed heights and/or charge levels.		P
	- detailed instructions on how to install the appliance to ensure that the release height h0 as determined in Clause GG.2 of the installed appliance is not lower than h0 used for the calculation of Amin;		P
	- a warning to keep any required ventilation openings clear of obstruction;		P
	- a notice that servicing shall be performed only as recommended by the manufacturer;		P
	- a warning that ducts connected to an appliance shall not contain a potential ignition source;		N/A
	- instructions for wiring to external zoning dampers and/or mechanical ventilation, if required to comply with Clause GG.9, to ensure that upon detection of a leak, the zoning dampers are driven fully open and additional mechanical ventilation is activated;		N/A
	- for appliances relying on safety measures according to GG.8.3 instructions for wiring to external ventilation;		N/A
	- when a remote located refrigerant sensor is specified by the manufacturer, the instructions shall state when it is required and how to install and connect the sensor;		N/A
	- for appliances using A2L refrigerants, connected via an air duct system to one or more rooms, the supply and return air shall be directly ducted to the space. Open areas such as false ceilings shall not be used as a return air duct;		N/A
	- the following information requirements apply for enhanced tightness refrigerating systems using A2L refrigerants:		P
	Equipment piping in the occupied space shall be installed in such a way to protect against accidental damage in operation and service.		P

IEC 60335-2-40			
Clause	Requirement + Test	Result - Remark	Verdict
	Precautions shall be taken to avoid excessive vibration or pulsation to refrigerating piping.		P
	Protection devices, piping and fittings shall be protected as far as possible against adverse environmental effects, for example, the danger of water collecting and freezing in relief pipes or the accumulation of dirt and debris.		P
	Provision shall be made for expansion and contraction of long runs of piping.		P
	Piping in refrigerating systems shall be so designed and installed to minimize the likelihood hydraulic shock damaging the system.		P
	Solenoid valves shall be correctly positioned in the piping to avoid hydraulic shock.		P
	Solenoid valves shall not block in liquid refrigerant unless adequate relief is provided to the refrigerant system low pressure side.		P
	Steel pipes and components shall be protected against corrosion with a rustproof coating before applying any insulation.		P
	Flexible pipe elements shall be protected against mechanical damage, excessive stress by torsion, or other forces. They should be checked for mechanical damage annually.		N/A
	The indoor equipment and pipes shall be securely mounted and guarded such that accidental rupture of equipment cannot occur from such events as moving furniture or reconstruction activities.		N/A
	Where safety shut off valves are specified, the minimum room area may be determined based on the maximum amount of refrigerant that can be leaked as determined in GG.12.2.		N/A
	Where safety shut off valves are specified, the location of the valve in the refrigerating system relative to the occupied spaces shall be as described in GG.12.1.		N/A
	Field-made refrigerant joints indoors shall be tightness tested. The test method shall have a sensitivity of 5 grams per year of refrigerant or better under a pressure of at least 0,25 times the maximum allowable pressure. No leak shall be detected.		N/A
	- For mechanical ventilation as specified in GG.8.3, the air extraction opening from the room shall be located equal or below the refrigerant release point. For floor mounted units, it shall be as low as practicable. The air extraction openings shall be located in a sufficient distance from the air intake openings to prevent re-circulation to the space.		N/A

IEC 60335-2-40			
Clause	Requirement + Test	Result - Remark	Verdict
DD.3.2	Unventilated areas		—
	For appliances containing more than m1 for any refrigerating circuit, the manual shall include a statement advising that an unventilated area where the appliance using flammable refrigerants is installed shall be so constructed that should any refrigerant leak, it will not stagnate so as to create a fire or explosion hazard. This shall include:		N/A
	- a warning that the non-fixed appliance shall be stored in an well-ventilated area where the room size corresponds to the room area as specified for operation;		N/A
	- a warning that the non-fixed appliance shall be stored in a room without continuously operating open flames (for example an operating gas appliance) and or other potential ignition sources (for example an operating electric heater, hot surfaces);		N/A
	- a warning that if appliances with A2L refrigerants connected via an air duct system to one or more rooms are installed in a room with an area less than Amin as determined in Clause GG.2, that room shall be without continuously operating open flames (for example an operating gas appliance) or other potential ignition sources (for example an operating electric heater, hot surfaces). A flame-producing device may be installed in the same space if the device is provided with an effective flame arrest;		N/A
	- for appliances using A2L refrigerants connected via an air duct system to one or more rooms, a warning with the substance of the following: "Auxiliary devices which may be a potential ignition source shall not be installed in the duct work. Examples of such potential ignition sources are hot surfaces with a temperature exceeding X°C and electric switching devices";		N/A
	- for appliances using A2L refrigerants connected via an air duct system to one or more rooms, a warning that only auxiliary devices approved by the appliance manufacturer or declared suitable with the refrigerant shall be installed in connecting ductwork. The manufacturer can list in the instructions all approved auxiliary devices by the manufacturer and model number for use with the specific appliance, if those devices have a potential to become an ignition source.		N/A
	The manufacturer should specify other potential continuously operating sources known to cause ignition of the refrigerant used.		P
DD.3.3	Qualification of workers		—

IEC 60335-2-40			
Clause	Requirement + Test	Result - Remark	Verdict
	The manual shall contain specific information about the required qualification of the working personnel for maintenance, service and repair operations. Every working procedure that affects safety means shall only be carried out by competent persons according to Annex HH.		P
	Examples for such working procedures are:		P
	breaking into the refrigerating circuit;		P
	opening of sealed components;		N/A
	opening of ventilated enclosures.		P
DD.4	Information on servicing		—
DD.4.1	General		—
	The manual shall contain specific information for service personnel according to DD.4.2 to DD.4.10.		P
DD.4.2	Checks to the area		—
	Prior to beginning work on systems containing flammable refrigerants, safety checks are necessary to ensure that the risk of ignition is minimised. For repair to the refrigerating system, DD.4.3 to DD.4.7 shall be completed prior to conducting work on the system.		P
DD.4.3	Work procedure		—
	Work shall be undertaken under a controlled procedure so as to minimise the risk of a flammable gas or vapour being present while the work is being performed.		P
DD.4.4	General work area		—
	All maintenance staff and others working in the local area shall be instructed on the nature of work being carried out. Work in confined spaces shall be avoided.		N/A
DD.4.5	Checking for presence of refrigerant		—
	The area shall be checked with an appropriate refrigerant detector prior to and during work, to ensure the technician is aware of potentially toxic or flammable atmospheres. Ensure that the leak detection equipment being used is suitable for use with all applicable refrigerants, i.e. non-sparking, adequately sealed or intrinsically safe.		P
DD.4.6	Presence of fire extinguisher		—
	If any hot work is to be conducted on the refrigerating equipment or any associated parts, appropriate fire extinguishing equipment shall be available to hand. Have a dry powder or CO2 fire extinguisher adjacent to the charging area.		P

IEC 60335-2-40			
Clause	Requirement + Test	Result - Remark	Verdict
DD.4.7	No ignition sources		—
	No person carrying out work in relation to a refrigerating system which involves exposing any pipe work shall use any sources of ignition in such a manner that it may lead to the risk of fire or explosion.		P
	All possible ignition sources, including cigarette smoking, should be kept sufficiently far away from the site of installation, repairing, removing and disposal, during which refrigerant can possibly be released to the surrounding space.		P
	Prior to work taking place, the area around the equipment is to be surveyed to make sure that there are no flammable hazards or ignition risks. "No Smoking" signs shall be displayed.		P
DD.4.8	Ventilated area		—
	Ensure that the area is in the open or that it is adequately ventilated before breaking into the system or conducting any hot work.		P
	A degree of ventilation shall continue during the period that the work is carried out.		P
	The ventilation should safely disperse any released refrigerant and preferably expel it externally into the atmosphere.		P
DD.4.9	Checks to the refrigerating equipment		—
	Where electrical components are being changed, they shall be fit for the purpose and to the correct specification.		P
	At all times the manufacturer's maintenance and service guidelines shall be followed. If in doubt, consult the manufacturer's technical department for assistance.		P
DD.4.10	Checks to electrical devices		—
	Repair and maintenance to electrical components shall include initial safety checks and component inspection procedures.		P
	If a fault exists that could compromise safety, then no electrical supply shall be connected to the circuit until it is satisfactorily dealt with. If the fault cannot be corrected immediately but it is necessary to continue operation, an adequate temporary solution shall be used. This shall be reported to the owner of the equipment so all parties are advised.		P
	Initial safety checks shall include:		—
	that capacitors are discharged: this shall be done in a safe manner to avoid possibility of sparking;		P

IEC 60335-2-40			
Clause	Requirement + Test	Result - Remark	Verdict
	that no live electrical components and wiring are exposed while charging, recovering or purging the system;		P
	that there is continuity of earth bonding.		P
DD.5	Repairs to sealed components		—
DD.5.1	During repairs to sealed components, all electrical supplies shall be disconnected from the equipment being worked upon prior to any removal of sealed covers, etc. If it is absolutely necessary to have an electrical supply to equipment during servicing, then a permanently operating form of leak detection shall be located at the most critical point to warn of a potentially hazardous situation.		N/A
DD.5.2	Particular attention shall be paid to the following to ensure that by working on electrical components, the casing is not altered in such a way that the level of protection is affected. This shall include damage to cables, excessive number of connections, terminals not made to original specification, damage to seals, incorrect fitting of glands, etc.		N/A
	Ensure that seals or sealing materials have not degraded to the point that they no longer serve the purpose of preventing the ingress of flammable atmospheres.		N/A
	Replacement parts shall be in accordance with the manufacturer's specifications.		N/A
DD.6	Repair to intrinsically safe components		—
	Do not apply any permanent inductive or capacitance loads to the circuit without ensuring that this will not exceed the permissible voltage and current permitted for the equipment in use.		P
	Intrinsically safe components are the only types that can be worked on while live in the presence of a flammable atmosphere. The test apparatus shall be at the correct rating.		P
	Replace components only with parts specified by the manufacturer. Other parts may result in the ignition of refrigerant in the atmosphere from a leak.		P
DD.7	Cabling		—
	Check that cabling will not be subject to wear, corrosion, excessive pressure, vibration, sharp edges or any other adverse environmental effects.		P
	The check shall also take into account the effects of aging or continual vibration from sources such as compressors or fans.		P
DD.8	Detection of flammable refrigerants		—

IEC 60335-2-40			
Clause	Requirement + Test	Result - Remark	Verdict
	Under no circumstances shall potential sources of ignition be used in the searching for or detection of refrigerant leaks. A halide torch (or any other detector using a naked flame) shall not be used.		P
	Electronic leak detectors may be used to detect refrigerant leaks but, in the case of flammable refrigerants, the sensitivity may not be adequate, or may need re-calibration.		P
	Ensure that the detector is not a potential source of ignition and is suitable for the refrigerant used. Leak detection equipment shall be set at a percentage of the LFL of the refrigerant and shall be calibrated to the refrigerant employed, and the appropriate percentage of gas (25 % maximum) is confirmed.		P
	Leak detection fluids are also suitable for use with most refrigerants but the use of detergents containing chlorine shall be avoided as the chlorine may react with the refrigerant and corrode the copper pipe-work.		P
	If a leak is suspected, all naked flames shall be removed/extinguished.		P
	If a leakage of refrigerant is found which requires brazing, all of the refrigerant shall be recovered from the system, or isolated (by means of shut off valves) in a part of the system remote from the leak.		P
DD.9	Removal and evacuation		—
	When breaking into the refrigerant circuit to make repairs – or for any other purpose – conventional procedures shall be used.		P
	However, for flammable refrigerants it is important that best practice is followed since flammability is a consideration.		P
	The following procedure shall be adhered to:		P
	remove refrigerant;		P
	purge the circuit with inert gas		P
	evacuate		P
	purge with inert gas		P
	open the circuit by cutting or brazing.		P
	The refrigerant charge shall be recovered into the correct recovery cylinders.		P
	For appliances containing flammable refrigerants other than A2L refrigerants, the system shall be purged with oxygen-free nitrogen to render the appliance safe for flammable refrigerants		P

IEC 60335-2-40			
Clause	Requirement + Test	Result - Remark	Verdict
	This process may need to be repeated several times. Compressed air or oxygen shall not be used for purging refrigerant systems.		P
	For appliances containing flammable refrigerants, other than A2L refrigerants, refrigerants purging shall be achieved by breaking the vacuum in the system with oxygen-free nitrogen and continuing to fill until the working pressure is achieved, then venting to atmosphere, and finally pulling down to a vacuum.		P
	This process shall be repeated until no refrigerant is within the system.		P
	When the final oxygen-free nitrogen charge is used, the system shall be vented down to atmospheric pressure to enable work to take place.		P
	Ensure that the outlet for the vacuum pump is not close to any potential ignition sources and that ventilation is available.		P
DD.10	Charging procedures		—
	In addition to conventional charging procedures, the following requirements shall be followed.		P
	Ensure that contamination of different refrigerants does not occur when using charging equipment. Hoses or lines shall be as short as possible to minimise the amount of refrigerant contained in them.		P
	Cylinders shall be kept in an appropriate position according to the instructions.		P
	Ensure that the refrigerating system is earthed prior to charging the system with refrigerant.		P
	Label the system when charging is complete (if not already).		P
	Extreme care shall be taken not to overfill the refrigerating system.		P
	Prior to recharging the system, it shall be pressure-tested with the appropriate purging gas.		P
	The system shall be leak-tested on completion of charging but prior to commissioning. A follow up leak test shall be carried out prior to leaving the site.		P
DD.11	Decommissioning		—
	Before carrying out this procedure, it is essential that the technician is completely familiar with the equipment and all its detail.		P

IEC 60335-2-40			
Clause	Requirement + Test	Result - Remark	Verdict
	It is recommended good practice that all refrigerants are recovered safely. Prior to the task being carried out, an oil and refrigerant sample shall be taken in case analysis is required prior to re-use of recovered refrigerant. It is essential that electrical power is available before the task is commenced.		P
	a) Become familiar with the equipment and its operation.		P
	b) Isolate system electrically.		P
	c) Before attempting the procedure, ensure that:		P
	mechanical handling equipment is available, if required, for handling refrigerant cylinders;		P
	all personal protective equipment is available and being used correctly;		P
	the recovery process is supervised at all times by a competent person;		P
	recovery equipment and cylinders conform to the appropriate standards.		P
	d) Pump down refrigerant system, if possible.		P
	e) If a vacuum is not possible, make a manifold so that refrigerant can be removed from various parts of the system.		P
	f) Make sure that cylinder is situated on the scales before recovery takes place.		P
	g) Start the recovery machine and operate in accordance with instructions.		P
	h) Do not overfill cylinders (no more than 80 % volume liquid charge).		P
	i) Do not exceed the maximum working pressure of the cylinder, even temporarily.		P
	j) When the cylinders have been filled correctly and the process completed, make sure that the cylinders and the equipment are removed from site promptly and all isolation valves on the equipment are closed off.		P
	k) Recovered refrigerant shall not be charged into another refrigerating system unless it has been cleaned and checked.		P
DD.12	Labelling		—
	Equipment shall be labelled stating that it has been de-commissioned and emptied of refrigerant.		P
	The label shall be dated and signed.		P

IEC 60335-2-40			
Clause	Requirement + Test	Result - Remark	Verdict
	For appliances containing flammable refrigerants, ensure that there are labels on the equipment stating the equipment contains flammable refrigerant.		P
DD.13	Recovery		--
	When removing refrigerant from a system, either for servicing or decommissioning, it is recommended good practice that all refrigerants are removed safely.		P
	When transferring refrigerant into cylinders, ensure that only appropriate refrigerant recovery cylinders are employed. Ensure that the correct number of cylinders for holding the total system charge is available. All cylinders to be used are designated for the recovered refrigerant and labelled for that refrigerant (i.e. special cylinders for the recovery of refrigerant). Cylinders shall be complete with pressure-relief valve and associated shut-off valves in good working order. Empty recovery cylinders are evacuated and, if possible, cooled before recovery occurs.		P
	The recovery equipment shall be in good working order with a set of instructions concerning the equipment that is at hand and shall be suitable for the recovery of all appropriate refrigerants including, when applicable, flammable refrigerants. In addition, a set of calibrated weighing scales shall be available and in good working order. Hoses shall be complete with leak-free disconnect couplings and in good condition. Before using the recovery machine, check that it is in satisfactory working order, has been properly maintained and that any associated electrical components are sealed to prevent ignition in the event of a refrigerant release. Consult manufacturer if in doubt.		P
	The recovered refrigerant shall be returned to the refrigerant supplier in the correct recovery cylinder, and the relevant waste transfer note arranged. Do not mix refrigerants in recovery units and especially not in cylinders.		P
	If compressors or compressor oils are to be removed, ensure that they have been evacuated to an acceptable level to make certain that flammable refrigerant does not remain within the lubricant. The evacuation process shall be carried out prior to returning the compressor to the suppliers. Only electric heating to the compressor body shall be employed to accelerate this process. When oil is drained from a system, it shall be carried out safely.		P
EE	ANNEX EE (NORMATIVE) (IEC 60335-2-40:2018) PRESSURE TESTS		—

IEC 60335-2-40			
Clause	Requirement + Test	Result - Remark	Verdict
EE.1	General		—
	All refrigerating system parts shall withstand the maximum allowable pressure expected in normal operation, abnormal operation, and standstill.		P
	compressor tested for compliance with IEC 60335-2-34 need not be additionally tested.		N/A
EE.2	Pressure test value determined under testing carried out in Clause 11		—
	A refrigerating system component that is exposed to pressure shall be subjected to measurement of the maximum allowable pressure developed in the refrigerating system when tested under the conditions specified in Clause 11.		P
	The pressure test value shall be at least three times the maximum allowable pressure developed during operation under Clause 11.		P
EE.3	Pressure test value determined under testing carried out in Clause 19		—
	A refrigerating system component that is exposed to pressure shall be subjected to measurement of the maximum allowable pressure developed in the refrigerating system when tested under the conditions specified in Clause 19.		P
	The pressure test value shall be at least three times the maximum allowable pressure developed during abnormal operation (see Clause 19).		P
EE.4	Pressure test value determined under testing carried out under standstill conditions		—
EE.4.1	In order to determine the standstill pressure, the appliance shall be soaked in the highest operating temperature specified by the manufacturer for 1 h with power off.		N/A
	A refrigerating system component that is exposed only to low side pressure shall be subjected to measurement of the maximum allowable pressure developed in the refrigerating system under the condition of standstill.		N/A
	The pressure test value shall be at least three times the maximum allowable pressure developed during standstill.		N/A
	Pressure gauges and control mechanisms need not be subjected to the test, provided the parts meet the requirements of the component.		N/A

IEC 60335-2-40			
Clause	Requirement + Test	Result - Remark	Verdict
EE.4.2	The pressure test shall be carried out on three samples of each component. The test samples are filled with a liquid, such as water, to exclude air and are connected in a hydraulic pump system. The pressure is raised gradually until the required test pressure is reached. The pressure is maintained for at least 1 min, during which time the sample shall not leak.		N/A
	Where gaskets are employed for sealing parts under pressure, leakage at gaskets is acceptable, provided the leakage only occurs at a value greater than 120 % of the maximum allowable pressure and the test pressure is still reached for the specified time. Additional sealing measures, such as an "O" ring, for pressure testing may be provided.		N/A
EE.5	Fatigue test option for Clause EE.1 and EE.4.2		—
EE.5.1	The components shall be subjected to a test at 66,7 % of the test pressure determined by Clauses EE.2, EE.3 or EE.4, provided the components comply with the fatigue test in Clause EE.5. This test is conducted on a separate sample.		N/A
EE.5.2	Three samples of each refrigerant-containing part shall be tested at the cyclic pressure values specified in EE.5.7 and EE.5.8 for the number of cycles specified in EE.5.6, as described in EE.5.4.		N/A
EE.5.3	The samples shall be considered to comply with EE.5.5 on completion of the test and if they do not rupture, burst, or leak.		N/A
EE.5.4	The test samples shall be filled with fluid, and shall be connected to a pressure driving source. The pressure shall be raised and lowered between the upper and lower cyclic values at a rate specified by the manufacturer. The pressure shall reach the specified upper and lower values during each cycle. The shape of the pressure cycle shall be such that the upper and lower pressure values shall be maintained for at least 0,1 s.		N/A
	the operating temperatures of the appliance under the conditions of steady state operation of Clause 11 are less than or equal to 125 °C for copper or aluminium, or 200 °C for steel, the test temperature of the component part or assembly shall be at least 20 °C.		N/A

IEC 60335-2-40			
Clause	Requirement + Test	Result - Remark	Verdict
	If the continuous operating temperature of the component exceeds 125 °C for copper or aluminium, or 200 °C for steel, the test temperature of the parts or assemblies that are at these temperatures, and subjected to the pressure, shall be at least 25 °C greater than the temperature of the part measured during the test of Clause 11 for copper or aluminium and 60 °C higher for steel.		N/A
	For other materials, the effects of temperature on the material fatigue characteristics shall be evaluated by conducting the test at the higher temperatures and considering the material characteristics at the higher temperatures.		N/A
EE.5.5	The pressure for the first cycle shall be the maximum evaporating pressure for low-pressure side components or the maximum condensing pressure for the high-pressure side components.		N/A
EE.5.6	The total number of cycles shall be 250 000. The test pressures shall be determined by EE.5.7 (except the first and last cycles as noted in EE.5.5 and EE.5.8).		N/A
EE.5.7	The pressure for the test cycles shall be as follows:		N/A
	a) For components subject to high side pressures, the upper pressure value shall not be less than the saturated vapour pressure of the refrigerant at 50 °C and the lower pressure value shall not be greater than the saturated vapour pressure of the refrigerant at 5 °C. For hot water heat pumps, the upper pressure shall not be less than 80 % of the maximum allowable pressure under the conditions of Clause 11.		N/A
	b) For components subjected to only low side pressures, the upper pressure value shall be not less than the saturated vapour pressure of the refrigerant at 30 °C and the lower pressure value shall be between 0 bar and the greater of 4,0 bar or the saturated vapour pressure of the refrigerant at – 13 °C.		N/A
EE.5.8	For the final test cycle, the test pressure shall be increased to two times the minimum upper pressure specified in EE.5.7.		N/A
FF	ANNEX FF (NORMATIVE) (IEC 60335-2-40:2018) LEAK SIMULATION TESTS		—
FF.1	General		—
	A leakage of refrigerant is simulated at the most critical point in the refrigeration refrigerating system.		N/A

IEC 60335-2-40			
Clause	Requirement + Test	Result - Remark	Verdict
	The method to simulate a leakage at the most critical point is to inject refrigerant vapour through a suitable capillary tube at that point.		N/A
	A critical point is a joint in the refrigerant system tubing, a bend of more than 90°, or other point judged to be a weak point in the refrigerant containing system due to the thickness of the metal, exposure to damage, sharpness of a bend or the manufacturing process.		N/A
	A quantity of refrigerant leaked is equal to the rated refrigerant charge amount or the amount that will leak as determined by test. The refrigerant is injected at the most critical point and the most unfavourable direction at ambient temperature (20 °C to -25 °C). Where LFL is referenced in this annex, the LFL shall be taken at the nominal composition as specified in ISO 817.		N/A
FF.2	Test methods		—
FF.2.1	The appliance is modified by introducing a simulated leak through a capillary tube. The leak rate shall be maintained at 25 % ± 5 % of the refrigerant charge in 1 min.		N/A
FF.2.2	During this test, the appliance is switched off or operated under normal operation at rated voltage, whichever gives the most unfavourable result unless a prepurge is activated prior to energizing any loads, in which case the test shall be conducted with the appliance operating. During a test where the appliance is operating, refrigerant gas injection is started at the same time as the appliance is switched on.		N/A
FF.2.3	For refrigerant blends, the test shall be carried out using the nominal composition as defined in ISO 817.		N/A
FF.2.4	The test is conducted in a room that is draft free and of sufficient size to conduct the test.		N/A
	The minimum volume (V) is: $V = (15 \times mc)/LFL$		N/A
	Care shall be taken that the installation of the capillary tube does not unduly influence the results of the test and that the structure of the appliance does not unduly influence the results of the test.		N/A
	The instrument used for monitoring the refrigerant gas concentration shall have a fast response to the gas concentration, typically 2 s to 3 s and shall be located so as to not unduly influence the results of the test.		N/A
	If gas chromatography is used to measure the refrigerant gas concentrations, the gas sampling in confined areas shall not exceed 2 ml every 30 s.		N/A

IEC 60335-2-40			
Clause	Requirement + Test	Result - Remark	Verdict
FF.2.5	The measured concentration of refrigerant gas surrounding the component shall not exceed 25 % of the LFL of the refrigerant gas, and shall not exceed 15 % of the LFL of the refrigerant gas for a time period of 5 min or the duration of the test if less than 5 min during and after the amount has been injected. The measured concentration of refrigerant gas surrounding a component that will not function during the prepurge time may exceed the 25 % of the LFL during the prepurge time.		N/A
	The LFL is as specified in Annex BB for the refrigerant used.		N/A
GG	ANNEX GG (NORMATIVE) (IEC 60335-2-40:2018) CHARGE LIMITS, VENTILATION REQUIREMENTS AND REQUIREMENTS FOR SECONDARY CIRCUITS		—
GG.1	Requirements for refrigerant charge limits		—
GG.1.1	General		P
	When a flammable refrigerant is used, the requirements for installation space of appliance and/or ventilation requirements are determined according to		P
	- the refrigerant charge (M) (mc) used in the appliance,		P
	- the installation location,		P
	- the type of ventilation of the location or of the appliance.		P
	Symbol mc denotes the refrigerant charge of a single refrigerating system. Where multiple refrigerating systems are servicing the same space, the refrigerating system with the largest refrigerant charge shall be used.		P
	Where the parameters lower flammability limit (LFL) and molecular weight (M) are referenced in Annex GG, the values used shall be based on WCF – Worst Case Formulation as defined in ISO 817.		P
GG.1.2	Determination of the case applicable		—
	Determine the case applicable based on the relationship of the refrigerant charge (mc) and m1, m2, m3, defined as follows:		N/A
	$m1 = 4 \times LFL$		N/A
	$m2 = 26 \times LFL$		N/A
	$m3 = 130 \times LFL$		N/A
	where LFL is the lower flammability limit in kg/m3 for the refrigerant used.		N/A

IEC 60335-2-40			
Clause	Requirement + Test	Result - Remark	Verdict
	For A2L refrigerants, m1, m2, m3 is defined as follows:		P
	m1 = 6 × LFL		P
	m2 = 52 × LFL		N/A
	m3 = 260 × LFL		N/A
	where LFL is the lower flammable limit in kg/m3 for the refrigerant used.		N/A
	If an appliance with A2L refrigerant has more than one refrigerating system, refrigerant charge (mc) refers to the refrigerating system with the largest charge serving the same space.		P
GG.1.3	Determination of unventilated room area for appliances using A2L refrigerants		—
	For the purpose of determination of room area (A) when used to calculate the maximum allowable refrigerant charge (mmax) in an unventilated space, the following shall apply.		N/A
	The room area (A) shall be defined as the room area enclosed by the projection to the floor of the walls, partitions and doors of the space in which the appliance is installed.		N/A
	Spaces connected by only drop ceilings, ductwork, or similar connections shall not be considered a single space.		N/A
	For units mounted higher than 1,6 m, and in compliance with GG.2.2, spaces divided by partition walls which are no higher than 1,6 m shall be considered a single space.		N/A
	For fixed appliances, rooms on the same floor and connected by an open passageway between the spaces can be considered a single room when determining compliance to Amin, if the passageway complies with all of the following.		N/A
	It is a permanent opening.		N/A
	It extends to the floor.		N/A
	It is intended for people to walk through.		N/A
	For fixed appliances, the area of the adjacent rooms, on the same floor, connected by permanent opening in the walls and/or doors between occupied spaces, including gaps between the wall and the floor, can be considered a single room when determining compliance to Amin, provided all of the following are met.		N/A
	The space shall have appropriate openings according to GG.1.4.		N/A

IEC 60335-2-40			
Clause	Requirement + Test	Result - Remark	Verdict
	The minimum opening area for natural ventilation An_{vmin} shall not be less than An_{vmin}		N/A
	The equation is not applicable for refrigerants with a molar mass less than 42, as the equation is based on the principle that the density of the gases generates sufficient driving force to be successfully used with natural ventilation.		N/A
GG.1.4	Opening conditions for connected rooms and natural ventilation		—
	When the openings for connected rooms or natural ventilation are required, the following conditions shall be applied.		N/A
	The area of any openings above 300 mm from the floor shall not be considered in determining compliance with An_{vmin} . The area of any openings above 300 mm from the floor shall not be considered in determining compliance with An_{vmin} .		N/A
	At least 50 % of the required opening area An_{vmin} shall be below 200 mm from the floor.		N/A
	The bottom of the lowest openings shall not be higher than the point of release when the unit is installed and not more than 100 mm from the floor.		N/A
	Openings are permanent openings which cannot be closed.		N/A
	The height of the openings between the wall and floor which connect the rooms are not less than 20 mm.		N/A
	A second higher opening shall be provided. The total size of the second opening shall not be less than 50 % of minimum opening area for An_{vmin} and shall be at least 1,5 m above the floor.		N/A
GG.2	Requirements for charge limits in unventilated areas		—
GG.2.1	General		—
	Clause GG.2 is applicable for appliances with a refrigerant charge $m1 < mc \leq m2$ and for non-fixed factory sealed single package units with a refrigerant charge of $m1 < mc \leq 2 \times m1$:		N/A
	For non-fixed factory sealed single package units with a refrigerant charge of $m1 < mc \leq 2 \times m1$, the requirements of Clause GG.7 apply.		N/A
	For systems using A2L refrigerants with a refrigerant charge of $m1 < mc \leq m3$ that comply with the conditions in 22.125, the requirements of Clause GG.10 can apply.		N/A
	For other appliances with a refrigerant charge of $m1 < mc \leq m2$:		N/A

IEC 60335-2-40			
Clause	Requirement + Test	Result - Remark	Verdict
	The maximum refrigerant charge in a room shall be in accordance with the following:		N/A
	$m_{max} = 2,5 \times (LFL)^{(5/4)} \times h_0 \times (A)^{1/2}$, not to exceed $m_{max} = SF \times LFL \times h_0 \times A$ (GG.8)		N/A
	or the required minimum floor area A_{min} to install an appliance with refrigerant charge m_c (kg) shall be in accordance with following:		N/A
	$A_{min} = (m_c / (2,5 \times (LFL)^{(5/4)} \times h_0))^2$, not less than $A_{min} = m_c / (SF \times LFL \times h_0)$ (GG.9)		N/A
	If the minimum installed height given by the manufacturer is higher than the reference installed height, then in addition A_{min} and m_{max} for the reference installed height have to be given by the manufacturer. An appliance may have multiple reference installed heights. In this case, A_{min} and m_{max} calculations shall be provided for all applicable reference installed heights.		N/A
	For appliances serving one or more rooms with an air duct system, the lowest opening of the duct connection to each conditioned space or any opening of the indoor unit greater than 5 cm ² , at the lowest position to the space, shall be used for h_0 . However, h_0 shall not be less than 0,6 m. A_{min} shall be calculated as a function of the opening heights of the duct to the spaces and the refrigerant charge for the spaces where leaked refrigerant may flow to, considering where the unit is located. A_{min} shall be calculated for the spaces where a duct is connected or an indoor unit is located. If all spaces have room area more than respective A_{min} , no further measure is required. If any room area of spaces is below A_{min} , measures according to Clause GG.8 or GG.9 shall be provided for appliances using A2L refrigerants.		N/A
GG.2.2	Appliances using A2L refrigerants with incorporated circulation airflow		—
GG.2.2.1	General		—
	Incorporated circulation airflow applies to fixed appliances only.		N/A
	When the fan incorporated to an appliance is continuously operated or operation is initiated by a refrigerant detection system with a sufficient circulation airflow rate (see also Table GG.2), the maximum refrigerant charge can be increased or minimum room area can be reduced according to the following:		N/A
	The maximum refrigerant charge in a room shall be in accordance with m_{max}		N/A

IEC 60335-2-40			
Clause	Requirement + Test	Result - Remark	Verdict
	or the required minimum room area A_{min} of installed appliance with refrigerant charge m_c (kg) shall be in accordance with A_{min}		N/A
	Circulation airflow (Table GG.2)		N/A
G.2.2.2	Continuous circulation airflow		—
	The fan shall run continuously, other than for short periods for maintenance and service. The airflow shall be detected continuously or monitored continuously. Within 10 s in the event that the airflow is reduced, the following actions shall be taken:		N/A
	Disable the compressor operation.		N/A
	Warn user that airflow is reduced.		N/A
GG.2.2.3	Circulation airflow activated by a refrigerant detection system		—
	If a refrigerant detection system is activated per Annex LL, the following actions shall be taken and continue for at least 5 min after the refrigerant detection system has reset:		N/A
	The fan shall be switched on.		N/A
	Disable the compressor operation unless the compressor operation reduces the leak rate or the total amount released to the indoor space.		N/A
	Where a remote refrigerant detection system is used in a room with multiple units, all of the detection system activated safety measures shall be applied to all units in the room which rely on the remote refrigerant detection system.		N/A
GG.3	Requirements for charge limits in areas with mechanical ventilation		—
	Mechanical ventilation applies to fixed appliances only.		N/A
	Mechanical ventilation occurs when the appliance enclosure or the room is provided with a ventilating system that, in the event of a leak, is intended to vent refrigerant into an area where there is not a potential ignition source and the gas can be readily dispersed.		N/A
	The appliance enclosure shall have a ventilation system that produces airflow within the appliance enclosure and meets the requirements of Clause GG.4 or is intended to be installed in a room that meets the requirements of Clause GG.5.		N/A
GG.4	Requirements for mechanical ventilation within the appliance enclosure		—

IEC 60335-2-40			
Clause	Requirement + Test	Result - Remark	Verdict
	The refrigerating circuit is provided with a separate enclosure that does not communicate with allow flow from inside the enclosure to the room. The appliance enclosure shall have a ventilation system that produces airflow from the appliance interior to the outside through a ventilation shaft.		N/A
	The manufacturer shall specify the ventilation shaft width and height, the maximum length and number of bends		N/A
	The negative pressure measurement in the interior of the appliance enclosure shall be 20 Pa or more and the flow rate to the exterior shall be at least Qmin.		N/A
GG.5	Requirements for mechanical ventilation for rooms complying with ISO 5149		—
	Machinery rooms shall meet the requirements of Clause 5 of ISO 5149-3:2014.		N/A
GG.6	Requirements for refrigerating systems employing secondary heat exchangers		—
	If a flammable refrigerant is used and the system contains a secondary heat exchanger, the heat exchanger shall not allow the release of refrigerant into areas served by the secondary heat exchanger fluid if these areas are covered by Annex GG. The following may be considered to comply with this requirement:		N/A
	- an open loop secondary system vented to the outside; or		N/A
	- an automatic air/refrigerant separator and pressure relief valve is placed in the secondary circuit on the outlet pipe from the evaporator or the condenser. The air/refrigerant separator and pressure relief valve is at a high level relative to the outlet of the heat exchanger where leaked refrigerant may accumulate. The pressure relief valve shall have a flow rating rated to discharge the refrigerant that can be released through the heat exchanger. The air/refrigerant separator and pressure relief valve shall discharge the refrigerant into a space compliant with the charge limitations in Annex GG or to the outside; or		N/A
	- a double wall heat exchanger, or		N/A
	- a refrigerant system where the pressure of the secondary circuit is always greater than the pressure of the primary circuit in the area of contact, or		N/A
	- the bursting of the secondary heat exchanger is avoided by		N/A

IEC 60335-2-40			
Clause	Requirement + Test	Result - Remark	Verdict
	1) the use of a freezing protection device (testing of which is described in item 2) below) which considers:		N/A
	fluid freezing point;		N/A
	distribution through the heat exchanger;		N/A
	glide of the evaporating refrigerant;		N/A
	service procedures that could lead to freeze damage, for example adding or removing the refrigerant in liquid phase from a heat exchanger containing standing water;		N/A
	2) specifying requirements for specific properties of the secondary heat exchanger fluid to prevent corrosion, including:		N/A
	water: the manufacturer shall specify in the installation manual the water quality necessary for the specified heat exchanger;		N/A
	brine: the manufacturer shall specify in the installation manual the type of brine and its permitted concentration range for which the heat exchanger is suitable.		N/A
GG.7	Non fixed factory sealed single package units with a refrigerant charge of $m_1 < m_c \leq 2 \times m_1$		—
GG.7.1	Determination of refrigerant charge		—
	For non-fixed factory sealed single package units (i.e. one functional unit in one enclosure) with a refrigerant charge amount of $m_1 < M m_c \leq 2 \times m_1$, the maximum refrigerant charge in a room shall be in accordance with m_{max}		N/A
	or the required minimum floor area, A_{min} , to install an appliance with refrigerant charge m_c shall be in accordance with A_{min}		N/A
	When the appliance is switched on, a fan shall operate continuously supplying a minimum airflow as under normal steady state conditions, even when the compressor is switched off by the thermostat.		N/A
GG.7.2	Mechanical requirements		—
GG.7.2.1	General		—
	The appliance shall withstand the effects of dropping and vibration during transport and normal use without leaking refrigerant.		P
GG.7.2.2	Random vibration test		—

IEC 60335-2-40			
Clause	Requirement + Test	Result - Remark	Verdict
	The appliance is tested in its final packaging for transport and shall withstand a random vibration test for 180 min according to ASTM D 4728-06. The power spectral density profiles to be applied are those specified in Figure X1.1 and Table X1.1 of ASTM D 4728-06:2012 for truck transportation.		P
GG.7.2.3	Drop test with packaging		—
	The appliance is tested in its final packaging for transport and shall withstand the following number of drops on a horizontal hardwood board 20 mm thick placed on a concrete or similar hard surface:		N/A
	one with the appliance held upright;		—
	one for each of the four edges of the bottom side, with the bottom side forming an angle of about 30° to the horizontal.		N/A
GG.7.2.4	Drop test without packaging		—
	The tests of GG.7.2.3 are repeated on the appliance without its packaging and with the drop height according to the Table GG.4		N/A
GG7.2.5	Test after installation		—
	The appliance is installed in accordance with the installation instructions. It is supplied at rated voltage or at the upper limit of the rated voltage range and operated at ambient temperature.		P
GG.7.3	Vibration test		—
	The appliance shall be constructed so that its operation does not cause resonance points in the piping connected to the compressor.		P
GG.8	Ventilated area requirements for appliances using A2L refrigerants		—
GG.8.1	General		—
	Clause GG.8 is applicable for appliances with a refrigerant charge $0 < mc \leq m3$.		N/A
	Ventilation shall be employed when refrigerant charge is $mc > mmax$.		N/A
	Natural and mechanical ventilation apply to fixed appliances only.		N/A
GG.8.2	Natural ventilation requirements for appliances using A2L refrigerants		—
GG.8.2.1	General		—
	Natural ventilation shall be permitted for A2L refrigerants on the conditions as outlined in GG.8.2.2 and GG.8.2.3.		N/A
	Subclause GG.8.2 is applicable for appliances with a refrigerant charge of $mc < m3$.		N/A

IEC 60335-2-40			
Clause	Requirement + Test	Result - Remark	Verdict
GG.8.2.2	Natural ventilation to occupied indoor space		N/A
	If natural ventilation is applied in occupied space, all of the following shall be met.		N/A
	- Natural ventilation shall be made to a room where sufficient air is available to dilute the refrigerant below the LFL.		N/A
	- Natural ventilation from an occupied space shall not be made to outdoor.		N/A
	- For natural ventilation opening provided to an unoccupied space, the total area of the space in which the appliance is installed and the adjacent space which is connected by the natural ventilation shall have a room area more than A_{min} according to Clause GG.2 for mc. If the total room area is not large enough, the measure of GG.8.3 or Clause GG.9 shall be taken.		N/A
	- The openings for natural ventilation shall comply with GG.1.4.		N/A
	The minimum opening area for natural ventilation shall be calculated using $An_{v_{min}}$		N/A
	The equation is not applicable for refrigerants with a molar mass less than 42, as the equation is based on the principle that the density of the gases generates sufficient driving force to be successfully used with natural ventilation.		N/A
GG.8.2.3	Natural ventilation to outdoors or unoccupied indoor space		—
	If natural ventilation is applied in occupied space, all of the following shall be met.		N/A
	- Natural ventilation to the outside is not allowed below ground level.		N/A
	- For natural ventilation opening provided to an unoccupied space, the total area of the space in which the appliance is installed and the adjacent space which is connected by the natural ventilation, shall have a room area more than A_{min} according to Clause GG.2 for mc. If the total room area is not large enough, other measure of GG.8.3 or Clause GG.9 shall be taken.		N/A
	- The openings for natural ventilation shall comply with GG.1.4.		N/A
	- The minimum opening area for natural ventilation shall be calculated using the following equation: m_{max} and $An_{v_{min}}$		N/A

IEC 60335-2-40			
Clause	Requirement + Test	Result - Remark	Verdict
	The equation is not applicable for refrigerants with a molar mass less than 42, as the equation is based on the principle that the density of the gases generates sufficient driving force to be successfully used with natural ventilation.		N/A
GG.8.3	Mechanical ventilation requirements for rooms with appliances using A2L refrigerants		—
GG.8.3.1.1	Continuous operation of the fan		—
	The fan shall run continuously, other than for short periods for maintenance and service. The airflow shall be detected continuously or monitored continuously. Within 10 s in the event that the airflow is reduced, the following actions shall be taken:		N/A
	- Disable the compressor operation unless the compressor operation reduces the leak rate or the total amount released to the indoor space.		N/A
	- Warn user that airflow is reduced.		N/A
GG.8.3.1.2	Fan activated by a refrigerant detection system		
	If a refrigerant detection system is activated per Annex LL, the following actions shall be taken and continue for at least 5 min after the refrigerant detection system has reset:		N/A
	- The fan shall be switched on.		N/A
	- Disable the compressor operation unless the compressor operation reduces the leak rate or the total amount released to the indoor space.		N/A
	The refrigerant detection system and controls shall maintain the purge cycle for at least 5 min after the refrigerant detection system has reset.		N/A
GG.8.3.2	Required airflow		—
	The airflow shall be calculated using of the formula below. Losses caused by ducts or other components in the air stream shall be considered.		N/A
G.8.3.3	Requirement for opening		—
	The lower edge of the opening of the mechanical ventilation shall not be more than 100 mm above the floor.		N/A
	The air extraction openings shall be located at sufficient distance from the air intake openings to prevent re-circulation to the space.		N/A
GG.9	Charge limits for appliances using A2L refrigerants connected via an air duct system to one or more rooms		—
GG.9.1	General		—

IEC 60335-2-40			
Clause	Requirement + Test	Result - Remark	Verdict
	Clause GG.9 is applicable for appliances with a refrigerant charge $0 < mc \leq m3$. The maximum refrigerant charge can be increased or the minimum room area can be reduced if the following requirements are met.		N/A
	The appliance shall be provided with a refrigerant detection system according to Annex LL, or the fan shall operate continuously and the airflow shall be monitored continuously.		N/A
	mmax shall be determined based on the total area of the conditioned space (TA) connected by ducts taking into consideration that the circulation airflow distributed to all the rooms by the appliance integral indoor fan will mix and dilute the leaking refrigerant before entering any room. In the case when no refrigerant detection system is provided then, spaces where the airflow may be limited by zoning dampers shall not be included in the determination of TA.		N/A
GG.9.2	Continuous circulation airflow		—
	The fan shall run continuously, other than for short periods for maintenance and service. The airflow shall be detected continuously or monitored continuously. Within 10 s in the event that the airflow is reduced, the following actions shall be taken:		N/A
	- Disable the compressor operation.		N/A
	- Warn user that airflow is reduced.		N/A
GG.9.3	Circulation airflow activated by a refrigerant detection system		—
	When a refrigerant detection system according to Annex LL operates, the following shall be initiated.		N/A
	Disable the compressor operation unless the compressor operation reduces the leak rate or the total amount of charge released to the indoor space.		N/A
	Fully open all zoning damper of the appliance and energize control signals to open any external zoning dampers if applicable.		N/A
	Activate additional mechanical ventilation, if required.		N/A
	The refrigerant detection system and controls shall maintain the above action until at least 5 min after the refrigerant detection system has reset. Building fire and smoke systems may override this function.		N/A
	If the continuous operation of duct fan is employed, additional ventilation shall also be continuously operated.		N/A

IEC 60335-2-40			
Clause	Requirement + Test	Result - Remark	Verdict
GG.10	Allowable charge for enhanced tightness refrigerating systems		—
GG.10.1	General		—
	Clause GG.10 is applicable to enhanced tightness refrigerating systems using A2L refrigerants with refrigerant charge $m1 < mc \leq$ number of indoor units $\times m2$, not to exceed $4 \times m2$.		N/A
	For appliances with more than one indoor unit, individual indoor unit cooling capacity shall not exceed 35 kW when tested in accordance with ISO 5151, ISO 13253, or ISO 15042 at T1 conditions.		N/A
	For heating only appliances with more than one indoor unit, individual indoor unit heating capacity shall not exceed 35 kW when tested in accordance with ISO 5151, ISO 13253, or ISO 15042 at H1 conditions.		N/A
	The appropriate measures to be taken shall be ventilation (natural or mechanical), safety shut-off valves and safety alarm, in conjunction with refrigerant detection systems as specified in GG.10.2 to GG.10.5.		N/A
	A safety alarm alone shall not be considered as an appropriate measure where occupants are restricted in their movement (see Clause GG.13).		N/A
GG.10.2	Requirement for units with incorporated circulation airflow to prevent stagnation		—
GG.10.2.1	General		N/A
	For indoor units where $h0$ as determined in Clause GG.2 is less than 1,8 m, and for indoor units connected to one or more spaces by ducts which supply or return air from the space at a height less than 1.8 m, circulation airflow for the purpose of mixing the air in the room shall be provided.		N/A
	Where mechanical ventilation is required per Subclause GG.10.4 or Subclause GG.10.5, units where $h0$ is equal or greater than 1,8 m, air circulation for the purpose of mixing the air in the room shall also be provided.		N/A
	The circulation shall operate continuously or be turned on by refrigerant detection systems. The minimum air velocity and minimum airflow shall be as follows:		N/A
	Minimum airflow = 240 m ³ /h		N/A
	Minimum air velocity		N/A
	The unit air velocity (v) shall be calculated as airflow divided by the nominal face area of the outlet. The grill area shall not be deducted.		N/A

IEC 60335-2-40			
Clause	Requirement + Test	Result - Remark	Verdict
	As an alternative, for airflow angles between 15 degrees and 90 degrees, the minimum air velocity (vmin) can be determined by linear interpolation of the values included in Table GG.5.		N/A
	Where a single remote refrigerant detection system sensor is used in a room with multiple units, this requirement shall apply to all units in the room which do not have a dedicated refrigerant detection system.		N/A
GG.10.2.2	Continuous circulation airflow		—
	The fan shall run continuously, other than for short periods for maintenance and service. The airflow shall be detected continuously or monitored continuously. Within 10 s in the event that the airflow is reduced, the following actions shall be taken:		N/A
	- Disable the compressor operation unless the compressor operation reduces the leak rate or the total amount released to the indoor space.		N/A
	- Warn user that airflow is reduced.		N/A
GG.10.2.3	Circulation airflow initiated by a refrigerant detection system		—
	When any refrigerant detection system is activated per Annex LL in response to a detected leak into the space, all indoor units in that room which are served by the same outdoor unit shall take the following actions and continue for at least 5 min:		N/A
	- The fan shall be switched on.		N/A
	- Disable the compressor operation unless the compressor operation reduces the leak rate or the total amount released to the indoor space.		N/A
GG.10.3	Required measures for allowable refrigerant charge		—
GG.10.3.1	Spaces except lowest underground floor of the building		—
	Where the refrigerant charge does not exceed maximum refrigerant charge in GG.10.4, no additional measures are required.		N/A
	Where the charge exceeds the maximum refrigerant charge in GG.10.4 but is less than or equal to the maximum refrigerant charge in GG.10.5, then at least one additional measure shall be taken in accordance with Clause GG.11, GG.12, or GG.13.		N/A
	Where the refrigerant charge exceeds the maximum refrigerant charge in GG.10.5, at least two additional measures are taken in accordance with Clause GG.11, GG.12, or GG.13.		N/A
GG.10.3.2	Lowest underground floor of the building		—

IEC 60335-2-40			
Clause	Requirement + Test	Result - Remark	Verdict
	Where the refrigerant charge exceeds the maximum refrigerant charge in GG.10.4, two additional measures shall be taken in accordance with Clause GG.11, GG.12, or GG.13.		N/A
	The refrigerant charge shall not exceed the maximum refrigerant charge in GG.10.5.		N/A
GG.10.4	Maximum refrigerant charge		—
	The maximum refrigerant charge m_{max} in a room and the required minimum room area A_{min} of the installed appliance with refrigerant charge m_c shall be in accordance with m_{max} and A_{min}		N/A
GG.10.5	Maximum refrigerant charge when employing additional measures		—
	The maximum refrigerant charge m_{max} and minimum room area A_{min} are calculated in accordance with m_{max} and A_{min}		N/A
GG.11	Ventilation for enhanced tightness refrigerating systems using A2L refrigerants		—
GG.11.1	General		—
	Ventilation shall be made to a place where sufficient air is available to dilute the leaked refrigerant such as outdoors or a large space. The indoor place used to provide ventilation air shall have sufficient volume, including the volume of the room in which the indoor unit is installed, to ensure that the maximum refrigerant charge specified in GG.10.4 is not exceeded.		N/A
GG.11.2	Natural ventilation		—
	If natural ventilation is applied, all of the following shall be met.		N/A
	- Natural ventilation from an occupied space shall not be made to outdoors.		N/A
	- For natural ventilation opening provided to an occupied space, the total area of the space in which the appliance is installed and the adjacent space which is connected by the natural ventilation shall have a room area more than A_{min} according to Clause GG.2 for m_c . If the total room area is not large enough, the measure of GG.11.3 shall be taken.		N/A
	- Openings for natural ventilation shall comply with GG.1.4.		N/A
	- The minimum opening area for natural ventilation shall be calculated using equation (GG.29): $An_{V_{min}}$		N/A

IEC 60335-2-40			
Clause	Requirement + Test	Result - Remark	Verdict
	The equation is not applicable for refrigerants with a molar mass less than 42, as the equation is based on the principle that the density of the gases generates sufficient driving force to be successfully used with natural ventilation.		N/A
G.11.3	Mechanical ventilation		
GG.11.3.1	Operation of mechanical ventilation		
	Operation shall be according to GG.8.3.1, and for all indoor units in the same space which are served by a single refrigerating system, the fan shall be switched on to provide the minimum circulation airflow per GG.10.2.		N/A
GG.11.3.2	Required airflow		
	For $(Q \times 0,25 \times LFL) / 10 < 1$, the airflow of the mechanical ventilation shall be at least the quantity that satisfies the following formula for m_c		N/A
	For $(Q \times 0,25 \times LFL) / 10 \geq 1$, the airflow shall be determined according the following formula for Q		N/A
GG.11.3.3	Mechanical ventilation openings		
	The upper edge of the air extraction opening from the room shall be located equal or below the refrigerant release point.		N/A
	For floor mounted units, openings shall be according to GG.8.3.3.		N/A
GG.11.3.4	Operation of mechanical ventilation		
	Mechanical ventilation shall be operated continuously or shall be switched on by a refrigerant detection system.		N/A
GG.12	Safety shut-off valves for enhanced tightness refrigerating systems using A2L refrigerants		—
GG.12.1	Location		
	Safety shut-off valves shall be located in a space with a room volume large enough so that the maximum refrigerant charge complies with GG.10.4, GG.10.5, or outside. Safety shutoff valve shall be positioned to enable access for maintenance by an authorized person.		N/A
GG.12.2	Design		—
	Safety shut-off valves shall be designed to close in the event of an electric power failure, e.g. spring return solenoid valves.		N/A
	If safety shut-off valves are used to comply with GG.10.4 or GG.10.5, then the released amount of refrigerant shall be limited to $0,5 \times LFL \times \text{room volume}$.		N/A

IEC 60335-2-40			
Clause	Requirement + Test	Result - Remark	Verdict
	The amount of refrigerant that can be leaked shall consider the response time of the sensor and the controller that activates the valves and the remaining amount of refrigerant that is contained in each section of the refrigerating system after the valves are closed.		N/A
GG.13	Safety alarms for enhanced tightness refrigerating systems using A2L refrigerants		—
GG.13.1	General		N/A
	If an alarm is employed to warn of a leak in the occupied space, the alarm shall warn of a refrigerant leak in accordance with GG.13.2. The alarm shall be turned on by the signal from the refrigerant detection system. The alarm shall also alert an authorized person to take appropriate action.		N/A
GG.13.2	Alarm system warning		N/A
GG.13.2.1	General		N/A
	The alarm system shall warn both audibly and visibly, such as both a loud (15 dBA above the background level) buzzer and a flashing light.		N/A
GG.13.2.2	Alarm for general occupancy		N/A
	At least one alarm inside the occupied space shall be installed. For the occupancy listed below, the alarm system shall also warn at a supervised location, such as the night porter's location, as well as the occupied space.		N/A
	Rooms, parts of buildings, building where		N/A
	sleeping facilities are provided,		N/A
	people are restricted in their movement,		N/A
	an uncontrolled number of people are present, or		N/A
	to which any person has access without being personally acquainted with the necessary safety precautions.		N/A
JJ	ANNEX JJ (NORMATIVE) (IEC 60335-2-40:2018) ALLOWABLE OPENING OF RELAYS AND SIMILAR COMPONENTS TO PREVENT IGNITION OF A2L REFRIGERANTS		—
JJ.1	General		—
	Annex JJ is applicable to electric components or devices of appliances using A2L refrigerants.		P

IEC 60335-2-40			
Clause	Requirement + Test	Result - Remark	Verdict
	Annex JJ defines the maximum size of openings in relays and similar components that prevents flame propagation to outside. A relay and similar components that comply with the requirements of this annex are not considered as a potential ignition source for A2L refrigerants.	Using A2L refrigerants.	P
JJ.2	Definition of the opening		--
	The effective diameter is the equivalent diameter of a circular opening that has the same quenching effect to an opening of any shape. The effective diameter of the opening of relays and similar components is defined as d_{eff}		N/A
JJ.3	Determination of maximum allowable opening		--
	Relays and similar components shall not be considered as a potential ignition source if the effective diameter of all holes complies with the following equation:		N/A
	Alternatively, a type test can be used to determine if relays and similar components are not a potential ignition source. This type test shall show that there is no propagation of a flame from any contact inside of the relay to the outside, for the concentration of the refrigerant as used for determining the maximum burning velocity. Where the type test is used, the effective diameter limit is 12 mm.		N/A
KK	ANNEX KK (NORMATIVE) (IEC 60335-2-40:2018) TEST METHOD FOR HOT SURFACE IGNITION TEMPERATURE FOR A2L		--
KK.1	General		--
	The hot surface ignition temperature of A2L refrigerants shall be determined according to Annex KK. The refrigerants shall be sprayed onto a horizontal flat plate surface which is set at the test temperature.		N/A
	The test system consists of a hot plate, a spray tube and a chimney. Figure KK.1, Figure KK.2 and Figure KK.3 display the set-up of the test apparatus.		N/A
KK.2	Test equipment requirements		--
	The hot plate shall have the following characteristics. The hot plate shall consist of a flat stainless steel plate with the dimensions:		N/A
	Diameter: 50 mm ± 2,0 mm		N/A
	Thickness: 6 mm -0/+2,0 mm		N/A
	Surface texture: ISO 1302		N/A

IEC 60335-2-40			
Clause	Requirement + Test	Result - Remark	Verdict
	The hot plate shall be positioned horizontally. The heaters shall provide uniform heating of the plate. All surfaces other than the test surface should be thermally insulated using ceramic fibre board capable to withstand 815 °C. This insulation shall be such that vapours cannot be ignited by other than the hot plate top surface.		N/A
	Spray system shall consist of a liquid supply, two valves (trap liquid volume of 1,0 cm ³ ± 0,2 cm ³), tubing for directing the spray. The spray tube from valve to the end shall have the following dimensions:		N/A
	Length: 250 mm ± 5,0 mm		N/A
	Outer diameter: ≤ 4 mm		N/A
	Inner diameter: 1,6 mm ± 0,1 mm		N/A
	Use a type K thermal couple with the individual wires spot welded on opposite sides of the centre of the upper surface of the hot plate.		N/A
	A borosilicate or quartz glass chimney shall be 230 mm ± 10 mm long and 70 mm ± 10 mm inner diameter . The chimney shall be supported so that it is vertically mounted and has a gap of 2,5 mm ± 0,2 mm between its bottom edge and the top on the insulation.		N/A
KK.3	Procedure		--
	The ambient conditions of the test shall be set at 23 °C ± 3 °C and 50 % RH ± 5 % RH. The chimney and hot plate establishes a constant air velocity during the test. This airflow dilutes the vapours so that an optimum (near stoichiometric) concentration for ignition develops over the hot surface.		N/A
	The test shall be performed in a laboratory fume hood. The test apparatus including the chimney top shall be located in the laminar flow region of the laboratory fume hood so the chimney flow is not disturbed.		N/A
	The end of the spray refrigerant line shall be placed 40 mm ± 10 mm above the hot plate and shall point at the centre of the hot plate. The tube shall be perpendicular to the horizontal plate.		N/A
	Operating steps:		N/A
	1) The hot plate shall be heated until a steady test temperature is maintained for 5 min. The plate temperature shall be kept within ±15 °C of the set-point during the test.		N/A

IEC 60335-2-40			
Clause	Requirement + Test	Result - Remark	Verdict
	2) Refrigerant used for the test shall be the nominal composition (NC) per ISO 817. Refrigerant from the liquid phase shall be trapped between valve 1 and valve 2. Open valve C to spray the liquid refrigerant onto the centre of the hot plate.		N/A
	3) Observe and record if ignition (flames) occurs or does not occur within 3 min after release.		N/A
	Care shall be given to avoid vapours getting under the insulation, any ignition outside of the chimney is due to ignition on surfaces hotter than the test surface.		N/A
	4) A minimum of 5 min of ventilation shall be allowed between runs to clear out reaction products and residual refrigerant.		N/A
	5) Perform a minimum of 5 repetitions trials at each temperature being tested.		N/A
	6) The temperature of the hot plate shall be set at 800 °C, if ignition occurs, then the plate temperature is to be reduced in increments of 20 °C until no ignition occurs in five trials. This temperature is to be recorded as the hot surface ignition temperature (HSIT).		N/A
KK.4	Test report		--
	The results shall be recorded in a test report. The report shall include all the information necessary for the interpretation of the test and all information required by the method used. The report shall include:		N/A
	documentation with the sample identity and composition,		N/A
	temperature where ignition did not occur and where ignition did occur if applicable.		N/A
	The reported hot surface ignition temperature shall be highest temperature with no ignition in five trials.		N/A
LL	ANNEX LL (NORMATIVE) (IEC 60335-2-40:2018) REFRIGERANT DETECTION SYSTEMS FOR A2L REFRIGERANTS		--
LL.1	General		--
	Refrigerant detection systems shall be set to be activated before the refrigerant concentration reaches 25 % of the LFL. Where LFL is referenced in this annex, the LFL shall be taken at WCF – Worst Case Formulation as specified in ISO 817.		N/A
LL.2	Function of the refrigerant detection systems		--

IEC 60335-2-40			
Clause	Requirement + Test	Result - Remark	Verdict
	The refrigerant detection systems shall be capable of detecting a pre-set level of the refrigerant concentration of the refrigerant that the sensor is designated to be used with and initiate the operation as defined in Annex GG.		N/A
LL.3	Refrigerant detection system range, accuracy and response time		—
	Refrigerant detection system shall make output according to the applicable clauses of Annex GG of this standard within 30 s when the sensor is put into refrigerant concentration of 25 % of LFL or lower.		N/A
	The refrigerant detection system, including the sensors, shall comply with the above requirements over the full range of operating temperature and humidity as specified by the appliance manufacturer		N/A
LL.4	Refrigerant detection system calibration		—
	The refrigerant detection systems shall be pre-set and calibrated (with an accuracy of $\pm 20\%$) from the factory for the refrigerant used.		N/A
LL.5	Electrical outputs for refrigerant detection system		—
	The device shall have an output in accordance with the applicable clauses of Annex GG of this standard.		N/A
LL.6	Vibration requirements		—
	A sensor shall withstand vibration without breakage or damage of parts and shall continue to function. The vibration parameters shall be defined based on the intended application and expected transportation. If vibration operating parameters are not established by the manufacturer, then a sample of the sensor shall be subject to the requirements defined below.		N/A
LL.7	Refrigerant detection system self-test routine		—
	The detection system shall include a means for self-testing the sensor to determine the output is at proper range. The test shall be run at least every hour and if a failure is detected, an alarm shall be activated.		N/A
	If the sensor has a defined life and requires replacement after a given period, then the detection system shall initiate an alarm or indication that replacement is required. If sensor becomes more sensitive with aging to generate false alarm, the end of life alarm can be omitted.		N/A
LL.8	Sensor identification		—
	The sensors shall be marked with		N/A

IEC 60335-2-40			
Clause	Requirement + Test	Result - Remark	Verdict
	name, trade mark or identification mark of the manufacturer or responsible vendor;		N/A
	model or type reference.		N/A
MM	ANNEX MM (NORMATIVE) (IEC 60335-2-40:2018) REFRIGERANT SENSOR LOCATION CONFIRMATION TEST		—
MM.1	General		—
	This test is applicable to appliances with refrigerant detection systems other than remote detection.		N/A
	The purpose of this test is to demonstrate that the sensor(s) of the refrigerant detection system(s), where required, will adequately detect refrigerant, in the event of a leak when installed in the location specified by the manufacturer.		N/A
	Compliance will be determined by measurement of the refrigerant concentration in the location of the sensor.		N/A
	The composition of the refrigerant used for the test shall be taken as the nominal composition as specified in ISO 817. Where LFL is referenced in this annex, the LFL shall be taken at the nominal composition as specified in ISO 817.		N/A
MM.2	Test methods		—
MM.2.1	The appliance is modified by introducing a simulated leak through a capillary tube. The leak rate shall be maintained at m_r in g/s. The simulated leak is applied for 1 min.		N/A
	The free volume (V_{free}) shall be determined by calculating the volume of the appliance bounded by a horizontal plane at the lowest point of the simulated leak, the appliance enclosure walls and the plane of the supply and return openings.		N/A
	The volume shall be reduced by the volume of components or enclosed compartments within the bounded space. Components and enclosed compartments within the bounded space with a volume of less than 0,001 m ³ can be ignored.		N/A
	A leakage of refrigerant in the refrigerating system is simulated at the unfavourable critical points for detection of the leak.		N/A

IEC 60335-2-40			
Clause	Requirement + Test	Result - Remark	Verdict
	A critical point is a joint in the refrigerant system tubing, a bend of more than 90 degrees, or other point judged to be a weak point in the refrigerant containing system due to the thickness of the metal, exposure to damage, sharpness of a bend or the manufacturing process, an unfavourable point is a point where the path between the leakage point and the point of detection location is more distant or more obstructed. The refrigerant is injected at the most critical point and the most unfavourable direction at ambient temperature (15 °C to 35 °C). The capillary tube shall discharge refrigerant into a chamber or similar device which will reduce the refrigerant velocity into the appliance or space.		N/A
	Care shall be taken that the installation of the capillary tube does not unduly influence the results of the test and that the structure of the appliance does not unduly influence the results of the test.		N/A
MM.2.2	During this test, following appliance operating modes shall be tested;		N/A
	- Fan OFF, and		N/A
	- Fan ON.		N/A
	If the minimum airflow specified by the manufacturer is not less than the minimum airflow specified in GG.2.2 or Clause GG.9, testing in the fan ON mode is not required.		N/A
MM.2.3	The appliance shall be installed according to the instructions.		N/A
	Appliances that can be installed in different positions shall be tested in all positions allowed by the manufacturer. The supply and return openings shall not be covered and the manufacturers recommended air-filters shall be installed per instructions.		N/A
M.2.5	The instrument used for monitoring the refrigerant gas concentration shall have a fast response to the gas concentration, at least 90 % response within 10 s (time constant 4,3 s) and shall be located as close to the intended sensor location as possible, but care should be taken not to unduly influence the results of the test. It shall be calibrated to have an accuracy of ± 1 % of gas concentration between 20 % and 30 % gas concentration.		N/A
	For small products where an additional sensor cannot be built-in, the evaluation of MM.2.6 shall suffice.		N/A
	The refrigerant gas concentrations sampling shall be made at least every 10 s.		N/A

IEC 60335-2-40			
Clause	Requirement + Test	Result - Remark	Verdict
NN	ANNEX NN (NORMATIVE) (IEC 60335-2-40:2018) FLAME ARREST ENCLOSURE VERIFICATION TEST FOR A2L REFRIGERANTS		—
NN.1	General		—
	Annex NN is applicable to appliances using A2L refrigerants		N/A
	A flame arrest enclosure is a device or assembly enclosing components with electrical contacts that are made and broken, or similar devices which may become a source of ignition which will withstand an internal ignition of a A2L refrigerant vapour which may enter it without suffering damage and without transmission of flame from the internal ignition to an external A2L refrigerant vapour of the same refrigerant.		N/A
	Electrical components enclosed in a flame arrest enclosure in compliance with the test procedures below shall not be considered as a source of ignition.		N/A
	If all openings in the enclosure comply with Annex JJ, the enclosure is deemed to comply.		N/A
	The following test requirements are based on consideration of IEC 60079-15:2010, Clause 17, as applicable to the products within the scope of IEC 60335-2-40, and specific to the use of flammable A2L refrigerants.		N/A
NN.2	Test method		—
OO	ANNEX OO (NORMATIVE) (IEC 60335-2-40:2018) UV RADIATION CONDITIONING		—
OO.1	Ten samples of the internal wiring are subjected to ultraviolet light conditioning according to Clause OO.2 or OO.3. When the internal wiring is provided in more than one colour, ten samples of each colour are subjected to this conditioning.		N/A
	The test samples are mounted on the inside of the cylinder in the ultraviolet light apparatus perpendicular to the light source and in such a way that the samples do not touch each other.		N/A

IEC 60335-2-40			
Clause	Requirement + Test	Result - Remark	Verdict
OO.2	The samples are to be exposed for 1 000 h to xenon-arc, method A, in accordance with ISO 4892-2. There shall be continuous exposure to light and intermittent exposure to water spray. The cycle shall consist of 102 min without water spray and 18 min with water spray. The apparatus shall operate with a water-cooled xenon-arc lamp, borosilicate glass inner and outer optical filters, a spectral irradiance of 0,35 W/m ² /nm at 340 nm and a black panel temperature of (65 ± 3) °C. The temperature of the chamber shall be (45 ± 3) °C. The relative humidity in the chamber shall be (50 ± 5) %.		N/A
OO.3	The samples are to be exposed for 720 h to open-flame carbon-arc, in accordance with ISO 4892-4. There shall be continuous exposure to light and intermittent exposure to water spray. The cycle shall consist of 102 min without water spray and 18 min with water spray. The apparatus shall operate with an open-flame carbon-arc lamp, borosilicate glass Type 1 inner and outer optical filters, a spectral irradiance of 0,35 W/m ² /nm at 340 nm and a black panel temperature of (63 ± 3) °C. The temperature of the chamber shall be (45 ± 3) °C. The relative humidity in the chamber shall be (50 ± 5) %.		N/A

IEC 60335-2-40			
Clause	Requirement + Test	Result - Remark	Verdict

10.1	TABLE: Power input deviation					P
Input deviation of/at:	P rated (W)	P measured (W)	ΔP	Required ΔP	Remark	
Outdoor unit model RAS-10J2AVRG-E matching with indoor unit model RAS-B10J2KVRG-E						
220V 50Hz	--	820,1	--	--	Cooling Mode	
230V 50Hz	1440	818,2	-43,1%	+15%	Cooling Mode	
240V 50Hz	--	818,4	--	--	Cooling Mode	
220V 50Hz	--	908,5	--	--	Heating Mode	
230V 50Hz	1440	908,5	-36,9%	+15%	Heating Mode	
240V 50Hz	--	907,9	--	--	Heating Mode	
Outdoor unit model RAS-16J2AVRG-E matching with indoor unit model RAS-B16J2KVRG-E						
220V 50Hz	--	1138,2	--	--	Cooling Mode	
230V 50Hz	1995	1085,7	-45,6%	+15%	Cooling Mode	
240V 50Hz	--	1175,0	--	--	Cooling Mode	
220V 50Hz	--	1114,7	--	--	Heating Mode	
230V 50Hz	1995	1118,7	-43,9%	+15%	Heating Mode	
240V 50Hz	--	1118,1	--	--	Heating Mode	
Outdoor unit model RAS-22J2AVRG-E matching with indoor unit model RAS-B22J2KVRG-E						
220V 50Hz	--	1090,0	--	--	Cooling Mode	
230V 50Hz	2220	1092,2	-50,8%	+15%	Cooling Mode	
240V 50Hz	--	1184,6	--	--	Cooling Mode	
220V 50Hz	--	1119,6	--	--	Heating Mode	
230V 50Hz	2220	1136,1	-51,1%	+15%	Heating Mode	
240V 50Hz	--	1106,4	--	--	Heating Mode	

IEC 60335-2-40			
Clause	Requirement + Test	Result - Remark	Verdict

10.1	TABLE: Power input deviation					P
Input deviation of/at:	P rated (W)	P measured (W)	ΔP	Required ΔP	Remark	
Outdoor unit model RAS-24J2AVRG-E matching with indoor unit model RAS-B24J2KVRG-E						
220V 50Hz	--	1285,8	--	--	Cooling Mode	
230V 50Hz	2670	1359,6	-49.0%	+15%	Cooling Mode	
240V 50Hz	--	1363,5	--	--	Cooling Mode	
220V 50Hz	--	1282,5	--	--	Heating Mode	
230V 50Hz	2670	1283,4	-51,9%	+15%	Heating Mode	
240V 50Hz	--	1286,1	--	--	Heating Mode	
Outdoor unit model RAS-24PAVSG-EE matching with indoor unit model RAS-24PKVSG-EE						
220V 50Hz	--	1277,9	--	--	Cooling Mode	
230V 50Hz	2670	1352,4	-49,3%	+15%	Cooling Mode	
240V 50Hz	--	1369,1	--	--	Cooling Mode	
220V 50Hz	--	1187,7	--	--	Heating Mode	
230V 50Hz	2670	1198,0	-44,8%	+15%	Heating Mode	
240V 50Hz	--	1207,6	--	--	Heating Mode	
Supplementary information: N/A						

IEC 60335-2-40			
Clause	Requirement + Test	Result - Remark	Verdict

10.2	TABLE: Current deviation					P
Current deviation of/at:	I rated (A)	I measured (A)	ΔI	Required ΔI	Remark	
Outdoor unit model RAS-10J2AVRG-E matching with indoor unit model RAS-B10J2KVRG-E						
220V 50Hz	--	4,11	--	--	Cooling Mode	
230V 50Hz	6,75	3,97	-41,1%	+15%	Cooling Mode	
240V 50Hz	--	3,85	--	--	Cooling Mode	
220V 50Hz	--	4,52	--	--	Heating Mode	
230V 50Hz	6,75	4,36	-35,4%	+15%	Heating Mode	
240V 50Hz	--	4,22	--	--	Heating Mode	
Outdoor unit model RAS-16J2AVRG-E matching with indoor unit model RAS-B16J2KVRG-E						
220V 50Hz	--	5,49	--	--	Cooling Mode	
230V 50Hz	8,95	5,05	-43,5%	+15%	Cooling Mode	
240V 50Hz	--	5,27	--	--	Cooling Mode	
220V 50Hz	--	5,40	--	--	Heating Mode	
230V 50Hz	8,95	5,22	-41,6%	+15%	Heating Mode	
240V 50Hz	--	5,00	--	--	Heating Mode	
Outdoor unit model RAS-22J2AVRG-E matching with indoor unit model RAS-B22J2KVRG-E						
220V 50Hz	--	5,20	--	--	Cooling Mode	
230V 50Hz	10,50	5,00	-52,3%	+15%	Cooling Mode	
240V 50Hz	--	5,20	--	--	Cooling Mode	
220V 50Hz	--	5,33	--	--	Heating Mode	
230V 50Hz	10,50	5,20	-50,4%	+15%	Heating Mode	
240V 50Hz	--	4,89	--	--	Heating Mode	

IEC 60335-2-40					
Clause	Requirement + Test			Result - Remark	Verdict
10.2	TABLE: Current deviation				P
Current deviation of/at:	I rated (A)	I measured (A)	ΔI	Required ΔI	Remark
Outdoor unit model RAS-24J2AVRG-E matching with indoor unit model RAS-B24J2KVRG-E					
220V 50Hz	--	6,03	--	--	Cooling Mode
230V 50Hz	12,80	6,11	-52,2	+15%	Cooling Mode
240V 50Hz	--	5,90	--	--	Cooling Mode
220V 50Hz	--	6,02	--	--	Heating Mode
230V 50Hz	12,80	5,79	-54,7%	+15%	Heating Mode
240V 50Hz	--	5,59	--	--	Heating Mode
Outdoor unit model RAS-24PAVSG-EE matching with indoor unit model RAS-24PKVSG-EE					
220V 50Hz	--	6,00	--	--	Cooling Mode
230V 50Hz	12,80	6,08	-52,5%	+15%	Cooling Mode
240V 50Hz	--	5,92	--	--	Cooling Mode
220V 50Hz	--	5,61	--	--	Heating Mode
230V 50Hz	12,80	5,43	-57,5%	+15%	Heating Mode
240V 50Hz	--	5,27	--	--	Heating Mode
Supplementary information: N/A					

IEC 60335-2-40				
Clause	Requirement + Test	Result - Remark	Verdict	
11.8	TABLE: Heating test, thermocouples		P	
	Mode of operation	Cooling mode	Heating mode	
	Test voltage (V).....:	254,4V(50Hz)	254,4V(50Hz)	—
	Ambient, t ₁ (°C)	32/46 (Indoor/outdoor)	28/24 (Indoor/outdoor)	
	Ambient, t ₂ (°C)	32/46 (Indoor/outdoor)	28/24 (Indoor/outdoor)	—
Thermocouple locations		T (°C)	T (°C)	T (°C)
Indoor unit: RAS-B10J2KVRG-E matching with outdoor unit: RAS-10J2AVRG-E				
RAS-B10J2KVRG-E (Indoor unit)				
Terminal block		34,6	30,9	85
Internal wire to PCB.		38,1	35,6	75
Capacitor C03 on PCB [T=105 °C]		38,8	37,9	105
Capacitor C109 on PCB. [T=105 °C]		41,6	41,8	105
Line filter L01 on PCB.		43,1	41,6	90
SW. Transformer T01 on PCB.		44,2	44,2	90
Ambient of relay RY01 on PCB.		51,1	50,7	Ref.
PCB.		43,4	42,7	145
Internal wire to stepping		33,4	33,2	75
Stepping motor winding		41,7	45,9	90
Stepping motor enclosure		42,9	47,2	Ref.
Internal wire to fan motor		36,3	34,6	75
Fan motor winding		42,4	41,3	105
Fan motor enclosure		41,3	39,9	Ref.
Middle of refrigerant coil		20,1	52,6	Ref.
Inlet of refrigerant pipe		20,1	56,5	Ref.
Outlet of refrigerant pipe		15,8	71,4	Ref.
Wall		25,0	32,3	90
External enclosure		28,1	44,4	85
Air outlet		18,2	49,3	Ref.
RAS-10J2AVRG-E (Outdoor unit)				
Insulation of supply cord		46,7	25,2	75
Terminal block		46,9	24,8	85
Internal wire to PCB.		49,8	29,9	75
Capacitor C07 on PCB. [T=85°C]		58,6	37,6	85
Capacitor C01 on PCB. [T=105°C]		50,1	29,7	105
Capacitor C106 on PCB. [T=105 °C]		57,7	39,1	105

IEC 60335-2-40				
Clause	Requirement + Test	Result - Remark	Verdict	
	Line filter L01 on PCB.	52,7	33,3	90
	Line filter L401 on PCB.	70,7	52,6	90
	Ambient of relay RY01 on PCB.	65,4	47,2	Ref.
	SW Transformer T01 on PCB.	60,8	42,0	90
	PCB.	58,7	40,0	145
	Internal wire to fan motor	53,1	20,5	75
	Fan motor winding	56,1	21,7	105
	Fan motor enclosure	56,1	21,7	Ref.
	Internal wire to comp.	66,5	46,2	75
	Compressor enclosure	92,3	79,9	Ref.
	4way valve	51,2	71,6	110
	Discharge refrigerant pipe	93,4	80,0	Ref.
	Middle of refrigerant coil	55,8	16,3	Ref.
	Suction refrigerant pipe	15,3	15,2	Ref.
	Wall	47,0	24,0	90
	External enclosure	47,2	24,0	85
	Air outlet	52,6	18,8	Ref.
Supplementary information: N/A				

IEC 60335-2-40				
Clause	Requirement + Test	Result - Remark	Verdict	
11.8	TABLE: Heating test, thermocouples		P	
	Mode of operation	Cooling mode	Heating mode	
	Test voltage (V).....:	254,4V(50Hz)	254,4V(50Hz)	—
	Ambient, t ₁ (°C)	32/46 (Indoor/outdoor)	28/24 (Indoor/outdoor)	
	Ambient, t ₂ (°C)	32/46 (Indoor/outdoor)	28/24 (Indoor/outdoor)	—
	Thermocouple locations	T (°C)	T (°C)	T (°C)
Indoor unit: RAS-B16J2KVRG-E matching with outdoor unit: RAS-16J2AVRG-E				
RAS-B16J2KVRG-E (Indoor unit)				
	Insulation of supply cord	34,6	31,6	75
	Terminal block	34,5	32,2	85
	Internal wire to PCB.	37,9	36,3	75
	Capacitor C03 on PCB. [T=105°C]	39,5	38,2	105
	Capacitor C109 on PCB. [T=105°C]	40,7	39,0	105
	Line filter L01 on PCB.	47,3	42,6	90
	SW. Transformer T01 on PCB.	44,4	42,9	90
	Ambient of relay RY01 on PCB.	48,6	45,2	Ref.
	PCB.	41,8	39,4	145
	Internal wire to stepping	32,5	32,9	75
	Stepping motor winding	34,6	35,8	90
	Stepping motor enclosure	34,6	35,1	Ref.
	Internal wire to fan motor	36,5	34,2	75
	Fan motor winding	46,1	42,5	105
	Fan motor enclosure	43,0	39,9	Ref.
	Middle of refrigerant coil	21,4	55,0	Ref.
	Inlet of refrigerant pipe	20,6	43,9	Ref.
	Outlet of refrigerant pipe	15,6	86,1	Ref.
	Wall	34,2	31,5	90
	External enclosure	24,7	41,4	85
	Air outlet	18,2	53,5	Ref.
RAS-16J2AVRG-E (Outdoor unit)				
	Terminal block	46,8	25,0	85
	Internal wire to PCB.	50,8	33,5	75
	Capacitor 07 on PCB. [T=85 °C]	56,5	41,9	85
	Capacitor 106 on PCB. [T=105 °C]	62,0	45,8	105
	Ambient of relay RY01 on PCB.	64,6	51,5	Ref.

IEC 60335-2-40				
Clause	Requirement + Test	Result - Remark	Verdict	
	Line filter L01 on PCB.	58,2	43,1	90
	SW Transformer T02 on PCB.	55,8	41,0	90
	SW Transformer T01 on PCB.	61,8	44,5	90
	PCB.	60,5	45,4	145
	Internal wire to reactor	53,8	38,7	75
	Reactor	67,8	49,8	90
	Internal wire to fan motor	55,9	14,6	75
	Fan motor winding	63,8	17,1	105
	Fan motor enclosure	62,3	16,5	Ref.
	Internal wire to comp.	50,8	34,6	75
	Compressor enclosure	79,5	93,5	Ref.
	Discharge refrigerant pipe	80,2	95,9	Ref.
	Middle of refrigerant coil	53,8	15,1	Ref.
	Suction refrigerant pipe	16,4	12,8	Ref.
	4 way value	53,2	90,5	110
	Wall	47,5	23,7	90
	External enclosure	46,7	24,0	85
	Air outlet	54,2	15,0	Ref.
Supplementary information: N/A				

IEC 60335-2-40			
Clause	Requirement + Test	Result - Remark	Verdict
11.8	TABLE: Heating test, thermocouples		P
	Mode of operation	Cooling mode	Heating mode
	Test voltage (V).....:	254,4V(50Hz)	254,4V(50Hz)
	Ambient, t ₁ (°C)	32/46 (Indoor/outdoor)	28/24 (Indoor/outdoor)
	Ambient, t ₂ (°C)	32/46 (Indoor/outdoor)	28/24 (Indoor/outdoor)
	Thermocouple locations	T (°C)	T (°C)
Indoor unit: RAS-B22J2KVRG-E matching with outdoor unit: RAS-22J2AVRG-E			
RAS-B22J2KVRG-E (Indoor unit)			
	Insulation of supply cord	33,5	75
	Terminal block	33,4	85
	Internal wire to PCB.	40,4	75
	Capacitor C03 on PCB. [T=105 °C]	37,0	105
	Capacitor C109 on PCB. [T=105 °C]	38,5	105
	Line filter L01 on PCB.	44,6	90
	SW. Transformer T01 on PCB.	42,5	90
	Ambient of Relay MRY01 on PCB.	49,2	Ref.
	PCB.	42,1	145
	Internal wire to fan motor	32,1	75
	Fan motor winding	42,7	105
	Fan motor enclosure	39,5	Ref.
	Internal wire to stepping	30,6	75
	Stepping motor winding	36,5	90
	Stepping motor enclosure	32,6	Ref.
	Cover fan motor	32,4	Ref
	Control Box	32,8	Ref
	Wall	31,6	90
	External enclosure	32,1	85
	Middle of refrigerant coil	20,8	Ref.
	Inlet of refrigerant pipe	18,0	Ref.
	Outlet of refrigerant pipe	17,1	Ref.
	Air outlet	19,6	Ref.
RAS-B22J2AVRG-E (Outdoor unit)			
	Terminal block	46,5	85
	Internal wire to PCB.	52,1	75
	Capacitor C08 on PCB. [T=85 °C]	57,6	85

IEC 60335-2-40				
Clause	Requirement + Test	Result - Remark	Verdict	
	Capacitor C106 on PCB. [T=105 °C]	61,2	51,6	105
	Capacitor C01 on PCB. [T=105 °C]	51,6	36,7	105
	Line filter L01 on PCB.	55,9	42,5	90
	SW Transformer T101 on PCB.	59,4	46,3	90
	SW Transformer T02 on PCB.	59,5	46,3	90
	Ambient of relay RY01 on PCB.	59,4	48,9	Ref.
	PCB.	62,3	50,8	145
	Internal wire to fan motor	52,6	19,1	75
	Fan motor winding	63,0	14,4	105
	Fan motor enclosure	61,1	14,2	Ref.
	Reactor	74,2	55,8	90
	4 Way Valve	69,3	38,0	110
	Cover Compressor	57,3	50,6	Ref
	Internal wire to compressor	67,2	57,4	75
	Compressor enclosure	90,6	98,2	Ref.
	Middle of refrigerant coil	55,2	15,6	Ref.
	Discharge refrigerant pipe	89,1	96,3	Ref.
	Suction refrigerant pipe	16,6	11,1	Ref.
	Wall	46,9	22,4	90
	External enclosure	46,9	23,3	85
	Air outlet	54,5	12,0	Ref.
Supplementary information: N/A				

IEC 60335-2-40				
Clause	Requirement + Test	Result - Remark	Verdict	
11.8	TABLE: Heating test, thermocouples		P	
	Mode of operation	Cooling mode	Heating mode	
	Test voltage (V).....:	254,4V(50Hz)	254,4V(50Hz)	—
	Ambient, t ₁ (°C)	32/46 (Indoor/outdoor)	28/24 (Indoor/outdoor)	
	Ambient, t ₂ (°C)	32/46 (Indoor/outdoor)	28/24 (Indoor/outdoor)	—
	Thermocouple locations	T (°C)	T (°C)	T (°C)
Indoor unit: RAS-B24J2KVRG-E matching with outdoor unit: RAS-24J2AVRG-E				
RAS-B24J2KVRG-E (Indoor unit)				
	Terminal block	31,1	32,1	85
	Internal wire to PCB.	37,1	34,8	75
	Capacitor C03 on PCB. [T=105 °C]	37,2	34,5	105
	Capacitor C109 on PCB. [T=105 °C]	36,9	33,5	105
	Ambient of relay RY01 on PCB.	43,5	41,3	Ref.
	Line filter L01 on PCB.	44,3	40,9	90
	Switching Transformer T01 on PCB.	40,4	36,2	90
	PCB.	36,4	36,3	145
	Internal wire to stepping	31,1	30,3	75
	Stepping motor winding	35,2	31,4	90
	Stepping motor enclosure	33,7	30,7	Ref.
	Internal wire to fan motor	31,6	29,4	75
	Fan motor winding	44,9	43,3	105
	Fan motor enclosure	40,7	39,2	Ref.
	Middle of refrigerant coil	19,4	44,6	Ref.
	Inlet of refrigerant pipe	17,4	48,1	Ref.
	Outlet of refrigerant pipe	16,2	73,2	Ref.
	Wall	26,1	36,4	90
	External enclosure	29,6	32,1	85
	Air outlet	19,0	45,2	Ref.
RAS-24J2AVRG-E (Outdoor unit)				
	Insulation of supply cord	46,8	24,2	75
	Terminal block	46,9	23,3	85
	Internal wire to PCB.	47,6	24,0	75
	Capacitor C08 on PCB. [T=85 °C]	55,6	29,0	85
	Capacitor C106 on PCB. [T=105 °C]	59,5	31,5	105
	Capacitor C01 on PCB. [T=105 °C]	49,3	23,6	105

IEC 60335-2-40				
Clause	Requirement + Test	Result - Remark	Verdict	
	Line filter L01 on PCB.	49,7	26,2	90
	SW Transformer T101 on PCB.	60,6	32,5	90
	SW Transformer T02 on PCB.	55,1	27,3	90
	Relay RY01 on PCB.	65,9	39,2	Ref.
	PCB.	59,3	32,2	145
	Internal wire to fan motor	55,4	19,1	75
	Fan motor winding	64,4	28,1	105
	Fan motor enclosure	61,0	24,7	Ref.
	Reactor 1	58,0	34,0	90
	Reactor 2	62,4	30,7	90
	4 Way Valve	74,0	28,7	110
	Internal wire to compressor	52,4	37,8	75
	Compressor enclosure	84,5	78,3	Ref.
	Middle of refrigerant coil	53,6	17,9	Ref.
	Discharge refrigerant pipe	84,4	76,3	Ref.
	Suction refrigerant pipe	17,6	19,9	Ref.
	Wall	45,7	23,7	90
	External enclosure	46,1	23,6	85
	Air outlet	52,4	17,6	Ref.
Supplementary information: N/A				

IEC 60335-2-40			
Clause	Requirement + Test	Result - Remark	Verdict
11.8	TABLE: Heating test, thermocouples		P
	Mode of operation	Cooling mode	Heating mode
	Test voltage (V).....:	254,4V(50Hz)	254,4V(50Hz)
	Ambient, t ₁ (°C)	32/46 (Indoor/outdoor)	28/24 (Indoor/outdoor)
	Ambient, t ₂ (°C)	32/46 (Indoor/outdoor)	28/24 (Indoor/outdoor)
Thermocouple locations		T (°C)	T (°C)
Indoor unit: RAS-24PKVSG-EE matching with outdoor unit: RAS-24PAVSG-EE			
RAS-24PKVSG-EE (Indoor unit)			
Terminal block	32,0	30,2	85
Internal wire to PCB.	39,3	38,2	75
Capacitor C03 on PCB. [T=105 °C]	41,0	38,4	105
Capacitor C109 on PCB. [T=105 °C]	40,9	40,5	105
Ambient of relay RY01 on PCB.	42,6	41,5	Ref.
Line filter L01 on PCB.	50,6	45,3	90
Switching Transformer T01 on PCB.	42,1	40,8	90
PCB.	41,8	39,9	145
Internal wire to stepping	31,4	30,1	75
Stepping motor winding	34,8	39,2	90
Stepping motor enclosure	31,3	35,2	Ref.
Internal wire to fan motor	32,7	30,0	75
Fan motor winding	45,2	39,6	105
Fan motor enclosure	40,7	35,9	Ref.
Middle of refrigerant coil	18,8	49,7	Ref.
Inlet of refrigerant pipe	18,5	50,1	Ref.
Outlet of refrigerant pipe	16,5	78,9	Ref.
Wall	31,4	30,4	90
External enclosure	31,9	28,7	85
Air outlet	18,4	50,9	Ref.
RAS-24PAVSG-EE (Outdoor unit)			
Insulation of supply cord	46,7	23,6	75
Terminal block	46,2	23,7	85
Internal wire to PCB.	47,4	24,5	75
Capacitor C08 on PCB. [T=85 °C]	55,9	31,9	85
Capacitor C106 on PCB. [T=105 °C]	58,2	34,1	105
Capacitor C01 on PCB. [T=105 °C]	48,3	24,4	105

IEC 60335-2-40				
Clause	Requirement + Test	Result - Remark	Verdict	
	Line filter L01 on PCB.	50,6	26,3	90
	SW Transformer T101 on PCB.	59,1	36,1	90
	SW Transformer T02 on PCB.	54,3	30,0	90
	Ambient of relay RY01 on PCB.	66,4	43,2	Ref.
	PCB.	58,8	35,5	145
	Internal wire to fan motor	55,3	18,0	75
	Fan motor winding	64,2	18,1	105
	Fan motor enclosure	61,0	17,5	Ref.
	Reactor 1	56,8	36,0	90
	Reactor 2	60,9	32,7	90
	4 Way Valve	64,5	31,3	110
	Internal wire to compressor	55,7	45,8	75
	Compressor enclosure	87,2	85,5	Ref.
	Middle of refrigerant coil	53,5	15,6	Ref.
	Discharge refrigerant pipe	86,1	86,2	Ref.
	Suction refrigerant pipe	18,5	16,4	Ref.
	Wall	45,7	23,6	90
	External enclosure	46,2	23,8	85
	Air outlet	52,2	14,3	Ref.
Supplementary information: N/A				

IEC 60335-2-40						
Clause	Requirement + Test	Result - Remark			Verdict	
11.8	TABLE: Heating test, resistance method				P	
	Mode of operation	Cooling mode			—	
	Test voltage (V)	32/46 (Indoor/outdoor)			—	
	Ambient, (°C).....	32/46 (Indoor/outdoor)			—	
Temperature rise of winding		R1 (Ω)	R2 (Ω)	T (°C)	Max. T (°C)	Insulation class
Outdoor unit model RAS-10J2AVRG-E matching with indoor unit model RAS-B10J2KVRG-E						
Compressor winding 1		2,69	3,19	100,6	140	Synthetic
Compressor winding 2		2,68	3,20	101,1	140	Synthetic
Compressor winding 3		2,68	3,20	100,4	140	Synthetic
4 Way value		2,347k	2,408k	53,3	120	Class B
Outdoor unit model RAS-16J2AVRG-E matching with indoor unit model RAS-B16J2KVRG-E						
Compressor winding 1		1,97	2,29	92,0	140	Synthetic
Compressor winding 2		1,98	2,30	92,3	140	Synthetic
Compressor winding 3		1,97	2,30	93,0	140	Synthetic
Reactor		0,42	0,46	75,8	100	Class A
4 Way value		1,612k	1,653k	55,0	120	Class B
Outdoor unit model RAS-22J2AVRG-E matching with indoor unit model RAS-B22J2KVRG-E						
Compressor winding 1		1,21	1,45	102,4	140	Synthetic
Compressor winding 2		1,20	1,44	102,6	140	Synthetic
Compressor winding 3		1,22	1,47	103,5	140	Synthetic
Reactor		0,42	0,45	69,7	100	Class A
4 Way value		2,435k	2,809k	89,1	120	Class B
Outdoor unit model RAS-24J2AVRG-E matching with indoor unit model RAS-B24J2KVRG-E						
Compressor winding 1		1,27	1,50	97,0	140	Synthetic
Compressor winding 2		1,27	1,51	101,1	140	Synthetic
Compressor winding 3		1,27	1,51	99,0	140	Synthetic
Reactor 1		0,22	0,23	63,1	100	Class A
Reactor 2		0,22	0,23	65,7	100	Class A
4 Way value		2,383k	2,694k	82,5	120	Class B

IEC 60335-2-40			
Clause	Requirement + Test	Result - Remark	Verdict

Outdoor unit model RAS-24PAVRG-EE matching with indoor unit model RAS-24PKVRG-EE					
Compressor winding 1	1,27	1,51	99,2	140	Synthetic
Compressor winding 2	1,27	1,51	100,3	140	Synthetic
Compressor winding 3	1,27	1,52	12,3	140	Synthetic
Reactor 1	0,22	0,23	64,5	100	Class A
Reactor 2	0,22	0,23	65,1	100	Class A
4 Way valve	2,383k	2,693k	82,4	120	Class B
Supplementary information: N/A					

IEC 60335-2-40						
Clause	Requirement + Test			Result - Remark		Verdict
11.8	TABLE: Heating test, resistance method				P	
	Mode of operation			Heating mode		—
	Test voltage (V)			28/24 (Indoor/outdoor)		—
	Ambient, (°C).....			28/24 (Indoor/outdoor)		—
Temperature rise of winding		R1 (Ω)	R2 (Ω)	T (°C)	Max. T (°C)	Insulation class
Outdoor unit model RAS-10J2AVRG-E matching with indoor unit model RAS-B10J2KVRG-E						
Compressor winding 1		2,45	2,99	58,2	140	Synthetic
Compressor winding 2		2,45	2,99	58,3	140	Synthetic
Compressor winding 3		2,46	3,02	59,8	140	Synthetic
4 Way value		2,169k	2,595k	51,6	120	Class B
Outdoor unit model RAS-16J2AVRG-E matching with indoor unit model RAS-B16J2KVRG-E						
Compressor winding 1		1,82	2,35	76,9	140	Synthetic
Compressor winding 2		1,83	2,36	77,0	140	Synthetic
Compressor winding 3		1,82	2,36	77,9	140	Synthetic
Reactor		0,38	0,43	30,0	100	Class A
4 Way value		1,483k	1,865k	67,5	120	Class B
Outdoor unit model RAS-22J2AVRG-E matching with indoor unit model RAS-B22J2KVRG-E						
Compressor winding 1		1,14	1,49	103,6	140	Synthetic
Compressor winding 2		1,14	1,49	104,7	140	Synthetic
Compressor winding 3		1,13	1,47	102,4	140	Synthetic
Reactor		0,38	0,42	56,3	100	Class A
4 Way value		2,238k	2,415k	44,5	120	Class B
Outdoor unit model RAS-24J2AVRG-E matching with indoor unit model RAS-B24J2KVRG-E						
Compressor winding 1		1,23	1,50	82,1	140	Synthetic
Compressor winding 2		1,22	1,49	81,6	140	Synthetic
Compressor winding 3		1,22	1,50	83,3	140	Synthetic
Reactor 1		0,20	0,20	35,5	100	Class A
Reactor 2		0,20	0,21	38,1	100	Class A
4 Way value		2,195k	2,290k	35,2	120	Class B

IEC 60335-2-40					
Clause	Requirement + Test			Result - Remark	Verdict
Outdoor unit model RAS-24PAVSG-EE matching with indoor unit model RAS-24PKVSG-EE					
Compressor winding 1	1,23	1,54	89,4	140	Synthetic
Compressor winding 2	1,22	1,52	88,0	140	Synthetic
Compressor winding 3	1,22	1,51	62,5	140	Synthetic
Reactor 1	0,20	0,20	31,1	100	Class A
Reactor 2	0,20	0,20	35,2	100	Class A
4 Way valve	2,195k	2,292k	35,4	120	Class B
Supplementary information: N/A					

13.2	TABLE: Leakage current		P
	Heating appliances: 1,15 x rated input (W)..... :	--	—
	Motor-operated and combined appliances: 1,06 x rated voltage (V)..... :	254,4	—
Leakage current between		I (mA)	Max. allowed I (mA)
Outdoor unit model RAS-10J2AVRG-E matching with indoor unit model RAS-B10J2KVRG-E (Cooling mode)			
Any pole of supply and earthed metal parts		2,10	3,50
Any pole of supply and accessible non-metallic material parts		0,02	0,25
Outdoor unit model RAS-10J2AVRG-E matching with indoor unit model RAS-B10J2KVRG-E (Heating mode)			
Any pole of supply and earthed metal parts		2,15	3,50
Any pole of supply and accessible non-metallic material parts		0,02	0,25
Outdoor unit model RAS-16J2AVRG-E matching with indoor unit model RAS-B16J2KVRG-E (Cooling mode)			
Any pole of supply and earthed metal parts		1,45	3,99
Any pole of supply and accessible non-metallic material parts		0,02	0,25
Outdoor unit model RAS-16J2AVRG-E matching with indoor unit model RAS-B16J2KVRG-E (Heating mode)			
Any pole of supply and earthed metal parts		1,40	3,99
Any pole of supply and accessible non-metallic material parts		0,02	0,25
Outdoor unit model RAS-22J2AVRG-E matching with indoor unit model RAS-B22J2KVRG-E (Cooling mode)			
Any pole of supply and earthed metal parts		1,5	4,44
Any pole of supply and accessible non-metallic material parts		0,02	0,25

IEC 60335-2-40			
Clause	Requirement + Test	Result - Remark	Verdict
Outdoor unit model RAS-22J2AVRG-E matching with indoor unit model RAS-B22J2KVRG-E (Heating mode)			
	Any pole of supply and earthed metal parts	1,75	4,44
	Any pole of supply and accessible non-metallic material parts	0,02	0,25
Outdoor unit model RAS-24J2AVRG-E matching with indoor unit model RAS-B24J2KVRG-E (Cooling mode)			
	Any pole of supply and earthed metal parts	0,75	5,34
	Any pole of supply and accessible non-metallic material parts	0,02	0,25
Outdoor unit model RAS-24J2AVRG-E matching with indoor unit model RAS-B24J2KVRG-E (Heating mode)			
	Any pole of supply and earthed metal parts	0,70	5,34
	Any pole of supply and accessible non-metallic material parts	0,03	0,25
Outdoor unit model RAS-24PAVSG-EE matching with indoor unit model RAS-24PKVSG-EE (Cooling mode)			
	Any pole of supply and earthed metal parts	0,76	5,34
	Any pole of supply and accessible non-metallic material parts	0,03	0,25
Outdoor unit model RAS-24PAVSG-EE matching with indoor unit model RAS-24PKVSG-EE (Heating mode)			
	Any pole of supply and earthed metal parts	0,72	5,34
	Any pole of supply and accessible non-metallic material parts	0,03	0,25
Supplementary information: N/A			

13.3	TABLE: Dielectric strength		P
Test voltage applied between:	Test potential applied (V)	Breakdown / flashover (Yes/No)	
Live parts and earthed metal parts	1000	No	
Parts separated by supplementary insulation	1750	No	
Live parts and accessible non-metallic material parts	3000	No	
Supplementary information: N/A			

14	TABLE: Transient overvoltages					N/A
Clearance between:	CI (mm)	Required CI (mm)	Rated impulse voltage (V)	Impulse test voltage (V)	Flashover (Yes/No)	
Supplementary information: N/A						

IEC 60335-2-40			
Clause	Requirement + Test	Result - Remark	Verdict
16.2	TABLE: Leakage current		P
	Single phase appliances: 1,06 x rated voltage (V):	254,4	
	Three phase appliances 1,06 x rated voltage divided by $\sqrt{3}$ (V)	--	—
Leakage current between		I (mA)	Max. allowed I (mA)
Outdoor unit model RAS-10J2AVRG-E matching with indoor unit model RAS-B10J2KVRG-E			
Live parts and earthed metal parts		0,22	3,50
Live parts and accessible non-metallic material parts		0,13	0,25
Outdoor unit model RAS-16J2AVRG-E matching with indoor unit model RAS-B16J2KVRG-E			
Live parts and earthed metal parts		0,23	3,99
Live parts and accessible non-metallic material parts		0,15	0,25
Outdoor unit model RAS-22J2AVRG-E matching with indoor unit model RAS-B22J2KVRG-E			
Live parts and earthed metal parts		0,22	4,44
Live parts and accessible non-metallic material parts		0,16	0,25
Outdoor unit model RAS-24J2AVRG-E matching with indoor unit model RAS-B24J2KVRG-E			
Live parts and earthed metal parts		0,23	5,34
Live parts and accessible non-metallic material parts		0,18	0,25
Outdoor unit model RAS-24PAVSG-EE matching with indoor unit model RAS-24PKVSG-EE			
Live parts and earthed metal parts		0,21	5,34
Live parts and accessible non-metallic material parts		0,17	0,25
Supplementary information: N/A			

16.3	TABLE: Dielectric strength		P
Test voltage applied between:		Test potential applied (V)	Breakdown / flashover (Yes/No)
Live parts and earthed metal parts		1250	No
Parts separated by supplementary insulation		1750	No
Live parts and accessible non-metallic material parts		3000	No
Supplementary information: N/A			

17	TABLE: Overload protection		N/A
Thermocouple locations		Max. temperature rise measured, ΔT (K)	Max. temperature rise limit, ΔT (K)
Supplementary information: N/A			

IEC 60335-2-40						
Clause	Requirement + Test			Result - Remark		Verdict
17	TABLE: Overload protection, resistance method					N/A
	Test voltage (V)					—
	Ambient, t1 (°C).....					—
	Ambient, t2 (°C).....					—
Temperature of winding		R1 (Ω)	R2 (Ω)	Δ T (K)	T (°C)	Max. T (°C)
Supplementary information: N/A						

IEC 60335-2-40							
Clause	Requirement + Test			Result - Remark			Verdict
19	Abnormal operation conditions						P
Operational characteristics		YES/NO		Operational conditions			
Are there electronic circuits to control the appliance operation?		Yes.		Normal operation with electronic circuit control operation of component e.g. compressor.			
Are there "off" or "stand-by" position?		No.		Normal operating			
The unintended operation of the appliance results in dangerous malfunction?		No.		No mechanical hazard or dangerous malfunction			
Sub-clause	Operating conditions description	Test results description	PEC description	EMP 19.11.4	Software type required	19.11.3 PEC	Final result
19.2	--	--	--	--	--	--	--
19.3	--	--	--	--	--	--	--
19.4	Stopping in any position by remote control and ON/OFF switch	operate in correct functions	--	--	--	--	No hazard
19.5	--	--	--	--	--	--	--
19.6	--	--	--	--	--	--	--
19.7	Indoor fan motor is locked	protective devices operate	Electronic circuit in PCB operate	P	--	P	No hazard
	Outdoor fan motor is locked	protective devices operate	Electronic circuit in PCB operate	P	--	P	No hazard
	Compressor is Locked	protective devices operate	Electronic circuit in PCB operate	P	--	P	No hazard
19.8	--	--	--	--	--	--	--
19.9	--	--	--	--	--	--	--
19.10	--	--	--	--	--	--	--
19.11.2	Open circuit and short circuit of component.	operate until steady conditions or stopped to operates	--	--	--	--	No hazard
19.11.4.8	--	--	--	--	--	--	--

IEC 60335-2-40							
Clause	Requirement + Test			Result - Remark			Verdict
19.101	Outdoor heat exchanger is restricted on cooling mode	operate until steady conditions	--	--	--	--	No hazard
19.103	Indoor and outdoor dry bulb temperature is increased 5K in cooling mode	operate until steady conditions	--	--	--	--	No hazard
Supplementary information: N/A							

19.4	Abnormal operation conditions		P
Failure description	Effect	Verdict	
Stopping in any position by remote control and ON/OFF switch	No effect the appliance can operate with correct functions	P	
Supplementary information: N/A			

IEC 60335-2-40						
Clause	Requirement + Test			Result - Remark	Verdict	
19.7	Abnormal operation conditions – locked rotor test other than motor-compressors and stationary circulation pumps in compliance with IEC 60335-2-51				P	
	Ambient, t1 (°C):			23 °C	—	
	Ambient, t2 (°C):			23 °C	—	
	Test voltage (V) :			240V	—	
Temperature limit T of winding:		R ₁ (Ω)	R ₂ (Ω)	Measured T (°C)	Limit T (°C)	Insulation class
Outdoor motor winding model: WDF-340-A43-1						
- Maximum temperature during 1 st hour		—	—	26,2	215	E
- Maximum temperature after 1 st hour		—	—	—	190	E
- Average temperature after 1 st hour		—	—	—	165	E
- Enclosure temperature		—	—	25,4	150	—
Outdoor motor winding model: ICF-140-43-4R						
- Maximum temperature during 1 st hour		—	—	36,0	215	E
- Maximum temperature after 1 st hour		—	—	—	190	E
- Average temperature after 1 st hour		—	—	—	165	E
- Enclosure temperature		—	—	36,0	150	—
Outdoor motor winding model: ICF-340-A70-1						
- Maximum temperature during 1 st hour		—	—	38,5	215	E
- Maximum temperature after 1 st hour		—	—	—	190	E
- Average temperature after 1 st hour		—	—	—	165	E
- Enclosure temperature		—	—	37,5	150	—
Indoor motor winding model: ICF-340-30-6						
- Maximum temperature during 1 st hour		—	—	73,5	215	E
- Maximum temperature after 1 st hour		—	—	—	190	E
- Average temperature after 1 st hour		—	—	—	165	E
- Enclosure temperature		—	—	70,8	150	—
Indoor motor winding model: DRM-340-30-2						
- Maximum temperature during 1 st hour		—	—	69,4	215	E
- Maximum temperature after 1 st hour		—	—	—	190	E
- Average temperature after 1 st hour		—	—	—	165	E
- Enclosure temperature		—	—	59,9	150	—

IEC 60335-2-40					
Clause	Requirement + Test			Result - Remark	Verdict
Indoor motor winding model: ICF-340U30-2					
- Maximum temperature during 1 st hour	—	—	50,9	215	E
- Maximum temperature after 1 st hour	—	—	—	190	E
- Average temperature after 1 st hour	—	—	—	165	E
- Enclosure temperature	—	—	50,9	150	—
Indoor motor winding model: MF-340-30-3, MF-340-30-4					
- Maximum temperature during 1 st hour	—	—	50,9	215	E
- Maximum temperature after 1 st hour	—	—	—	190	E
- Average temperature after 1 st hour	—	—	—	165	E
- Enclosure temperature	—	—	50,9	150	—
Indoor motor winding model: MF-340-30-1RT					
- Maximum temperature during 1 st hour	—	—	50,9	215	E
- Maximum temperature after 1 st hour	—	—	—	190	E
- Average temperature after 1 st hour	—	—	—	165	E
- Enclosure temperature	—	—	50,9	150	—
Supplementary information: N/A					

19.7	TABLE: electric strength measurements after 72 hours		P
Test voltage applied between:		Test voltage (V)	Breakdown Yes / No
Live parts and earthed metal parts		1250	No
Parts separated by supplementary insulation		1750	No
Supplementary information: N/A			

IEC 60335-2-40			
Clause	Requirement + Test	Result - Remark	Verdict
19.7	TABLE: leakage current measurements after 72 hours		P
	A voltage equal to twice the rated voltage (V) :	480V	—
Leakage current I between:		I (mA)	Required I (mA)
Live parts and accessible metal parts (WDF-340-A43-1)		0,17	2,0
Live parts and accessible metal parts (ICF-140-43-4R)		1,50	2,0
Live parts and accessible metal parts (ICF-340-A70-1)		0,19	2,0
Live parts and accessible metal parts (ICF-340-30-6)		0,20	2,0
Live parts and accessible metal parts (DRM-340-30-2)		0,22	2,0
Live parts and accessible metal parts (ICF-340U30-2)		1,50	2,0
Live parts and accessible metal parts (MF-340-30-3, MF-340-30-4)		1,50	2,0
Live parts and accessible metal parts (MF-340-30-1RT)		1,50	2,0
Supplementary information: N/A			

19.7	Abnormal operation conditions – Locked rotor test motor-compressor				P
	Motor-compressor	KSK89D53UFZ			
	Start device	--			
	Protector	--			
	Start capacitor	--			
	Run capacitor	--			
	Cooling; (static); (fan-m ³ /h); (oil);	Static			
	Thermal motor-protection system	Electromechanical protection system			
		Self-resetting			Manually reset
Rated voltage		Vn max (V)		Vn max (V)	Vn min (V)
		After 72 h	After 288 h	After 360 h	After 363 h
High-voltage test (see 16.3)		--	--	--	1250
Leakage current (mA) (see 16.2)		--	--	--	0,20
Electric strength (see 13.3)		--	--	--	1000
Room temperature (°C) (20 ± 5°C)		--	--	--	20,1
Number of cycles (≥ 2000 or 50)		--	--	--	50
Housing temperature (°C) (≤ 150°C)		--	--	--	25,5
supplementary information: N/A					

IEC 60335-2-40					
Clause	Requirement + Test	Result - Remark			Verdict
19.7	Abnormal operation conditions – Locked rotor test motor-compressor				P
	Motor-compressor	KSN108D22UFZ			
	Start device	--			
	Protector	--			
	Start capacitor	--			
	Run capacitor	--			
	Cooling; (static); (fan-m ³ /h); (oil);	Static			
	Thermal motor-protection system	Electromechanical protection system			
		Self-resetting			Manually reset
Rated voltage		Vn max (V)			Vn min (V)
		After 72 h	After 288 h	After 360 h	After 363 h
		After 50 cycles			
High-voltage test (see 16.3)		--	--	--	--
Leakage current (mA) (see 16.2)		--	--	--	--
Electric strength (see 13.3)		--	--	--	--
Room temperature (°C) (20 ± 5°C)		--	--	--	--
Number of cycles (≥ 2000 or 50)		--	--	--	--
Housing temperature (°C) (≤ 150°C)		--	--	--	--
supplementary information: N/A					

IEC 60335-2-40					
Clause	Requirement + Test	Result - Remark			Verdict
19.7	Abnormal operation conditions – Locked rotor test motor-compressor				P
	Motor-compressor	KTN130D30UFZ			
	Start device	--			
	Protector	--			
	Start capacitor	--			
	Run capacitor	--			
	Cooling; (static); (fan-m ³ /h); (oil);	Static			
	Thermal motor-protection system	Electromechanical protection system			
		Self-resetting			Manually reset
Rated voltage		Vn max (V)			Vn min (V)
		After 72 h	After 288 h	After 360 h	After 363 h
		After 50 cycles			
High-voltage test (see 16.3)		--	--	--	--
Leakage current (mA) (see 16.2)		--	--	--	--
Electric strength (see 13.3)		--	--	--	--
Room temperature (°C) (20 ± 5°C)		--	--	--	--
Number of cycles (≥ 2000 or 50)		--	--	--	--
Housing temperature (°C) (≤ 150°C)		--	--	--	--
supplementary information: N/A					

IEC 60335-2-40					
Clause	Requirement + Test	Result - Remark			Verdict
19.7	Abnormal operation conditions – Locked rotor test motor-compressor				P
	Motor-compressor	DX151A1T-30N			
	Start device	--			
	Protector	--			
	Start capacitor	--			
	Run capacitor	--			
	Cooling; (static); (fan-m ³ /h); (oil);	Static			
	Thermal motor-protection system	Electromechanical protection system			
		Self-resetting			Manually reset
Rated voltage		Vn max (V)			Vn min (V)
		After 72 h	After 288 h	After 360 h	After 363 h
		After 50 cycles			
High-voltage test (see 16.3)		--	--	--	--
Leakage current (mA) (see 16.2)		--	--	--	--
Electric strength (see 13.3)		--	--	--	--
Room temperature (°C) (20 ± 5°C)		--	--	--	--
Number of cycles (≥ 2000 or 50)		--	--	--	--
Housing temperature (°C) (≤ 150°C)		--	--	--	--
supplementary information: N/A					

IEC 60335-2-40			
Clause	Requirement + Test	Result - Remark	Verdict

19.11.2	Abnormal Operation			P
Fault condition	Short circuit	Open circuit	Effect	Verdict
Terminal	--	X	operate until steady conditions or stopped to operates	P
Capacitor	X	--	operate until steady conditions or stopped to operates	P
Electronic component	X	--	operate until steady conditions or stopped to operates	P

19.13	TABLE: Abnormal operation, temperature rises			P
Thermocouple locations	Max. temperature rise measured, ΔT (K)	Max. temperature rise limit, ΔT (K)		
Insulation of supply cord	56,9	175		
Wall	55,5	175		
Supplementary information: N/A				

19.101-104	Abnormal operation conditions		P
Subclause	Effect	Verdict	
19.101	Protective device operated	P	
19.102	--	N/A	
19.103	Protective device operated	P	
19.104	--	N/A	
Supplementary information: N/A			

21.1	TABLE: Impact resistance			P
Impacts per surface	Surface tested	Impact energy (Nm)	Comments	
Three	Indoor front panel	0,5	No damage	
Three	Cover of signal receiver	0,5	No damage	
Three	Cover of ON/OFF switch	0,5	No damage	
Three	Indoor return grille	0,5	No damage	
Three	Indoor enclosure	0,5	No damage	
Three	Outdoor fan guard	0,5	No damage	
Three	Outdoor Handle	0,5	No damage	
Supplementary information: N/A				

IEC 60335-2-40					
Clause	Requirement + Test			Result - Remark	Verdict
24.1	TABLE: Critical components information				P
Object / part No.	Manufacturer/ trademark	Type / model	Technical data	Standard	Mark(s) of conformity ¹)
Components for outdoor model: RAS-10J2AVRG-E, RAS-10J2AVRG-TR, RAS-13J2AVRG-E, RAS-13J2AVRG-TR					
Compressor	GMCC	KSK89D53UF Z	DC Comp Input: 712W ; Current: 4.85 A; R32	IEC/EN 60335-2-40 IEC/EN 60335-1	Tested with appliance
Components for outdoor model: RAS-16J2AVRG-E, RAS-16J2AVRG-TR					
Compressor	GMCC	KSN108D22U FZ	DC Comp Input: 890W; Current: 6,05 A; R32	IEC/EN 60335-2-40 IEC/EN 60335-1	Tested with appliance
Components for outdoor model: RAS-18J2AVRG-E, RAS-18J2AVRG-TR, RAS-22J2AVRG-E, RAS-22J2AVRG-TR					
Compressor	GMCC	KTN130D30U FZ	DC Comp Input: 1075 W; Current: 7.10 A; R32	IEC/EN 60335-2-40 IEC/EN 60335-1	Tested with appliance
Components for outdoor model: RAS-24J2AVRG-E, RAS-24J2AVRG-TR, RAS-24PKVSG-EE					
Compressor	TCFG	DX151A1T- 30N	DC Comp Input: 1075 W; Current: 7.10 A; R32	IEC/EN 60335-2-40 IEC/EN 60335-1	Tested with appliance
Components for outdoor model: For all model					
Fan Motor (For 10, 13, 16, 18, 22J2AVRG-E, -TR models)	WELLING	WDF-340- A43-1	DC140V-340V; 43W; Class E	IEC/EN 60335-2-40 IEC/EN 60335-1	Tested with appliance
Fan Motor (Alternative)	NIDEC	ICF-140-43- 4R	DC140V; 43W; Class E	IEC/EN 60335-2-40 IEC/EN 60335-1	Tested with appliance
Fan Motor (For 24J2AVRG-E, -TR ,24PAVSG-EE models)	NIDEC	ICF-340-A70- 1	DC 140-340V; 70W; Class E	IEC/EN 60335-2-40 IEC/EN 60335-1	Tested with appliance
4-Way Valve Coil	SANHUA	SQ, PQ	AC 220-240V; 50/60Hz; Class B	IEC/EN 60335-2-40 IEC/EN 60335-1	Tested with appliance
4-Way Valve Coil (Alternative)	DUNAN	DXQ	AC 220-240V; 50/60Hz; Class B	IEC/EN 60335-2-40 IEC/EN 60335-1	Tested with appliance
4-Way Valve Coil (Alternative)	DUNAN	DFS-4	AC 220-240V; 50/60Hz; Class B	IEC/EN 60335-2-40 IEC/EN 60335-1	Tested with appliance

IEC 60335-2-40			
Clause	Requirement + Test	Result - Remark	Verdict

24.1	TABLE: Critical components information					P
Object / part No.	Manufacturer/ trademark	Type / model	Technical data	Standard	Mark(s) of conformity ¹)	
4-Way Valve Coil (Alternative)	SAGINOMIYA	STF, VHV, VPV	AC 220-240V; 50/60Hz; Class B	IEC/EN 60335-2-40 IEC/EN 60335-1	Tested with appliance	
PMV Coil	SANHUA	PQ	DC 12V; Class E	IEC/EN 60335-2-40 IEC/EN 60335-1	Tested with appliance	
PMV Coil (Alternative)	FUJIKOKI	CAM	DC 12V; Class E	IEC/EN 60335-2-40 IEC/EN 60335-1	Tested with appliance	
PMV Coil (Alternative)	TAIHEIYO	C12A	DC 12V; Class E	IEC/EN 60335-2-40 IEC/EN 60335-1	Tested with appliance	
REACTOR (For16k, 18k, 22k models)	TABUCHI	CH-69	47W; 59,7V	IEC/EN 60335-2-40 IEC/EN 60335-1	Tested with appliance	
REACTOR (Alternative)	DPC	CH-69	47W; 59,7V	IEC/EN 60335-2-40 IEC/EN 60335-1	Tested with appliance	
REACTOR (Alternative)	TABUCHI	CH-51	47W; 59,7V	IEC/EN 60335-2-40 IEC/EN 60335-1	Tested with appliance	
REACTOR (For24k model)	TABUCHI	CH-47	50W; 40,2V	IEC/EN 60335-2-40 IEC/EN 60335-1	Tested with appliance	
Terminal Block	JINLONG	JXO-5B	5P; 250V; 20A	IEC/EN 60335-2-40 IEC/EN 60335-1	Tested with appliance	
Print Circuit Board (For 10, 13J2AVRG-E, -TR models)	TOSHIBA	WP-032	Material: Glass Epoxy Resin UL 94 flame	IEC/EN 60335-2-40 IEC/EN 60335-1	Tested with appliance	
Print Circuit Board (For 16, 18, 22, 24J2AVRG-E,-TR, 24PAVSG-EE models)	TOSHIBA	WP-030	Material: Glass fiber epoxy resin	IEC/EN 60335-2-40 IEC/EN 60335-1	Tested with appliance	
Components for Printed circuit board model: WP-032						
Fuse (F01)	NIPPON SEISEN	GDT	15A; 250VAC	IEC/EN 60335-2-40 IEC/EN 60335-1	Tested with appliance	
Fuse (F02, F03)	PICO	SCT	3.15A; 250VAC	IEC/EN 60127-2	SEMKO, VDE	
Fuse (F02, F03) (Alternative)	NIPPON SEISEN	FJL	3.15A; 250VAC	IEC/EN 60127-2	SEMKO	
Fuse (F02, F03) (Alternative)	SOC	ET	3.15A; 250VAC	IEC/EN 60127-2	SEMKO	
Switching Transformer (T101)	TDK	ST-04	Input: AC 176-276; Output: 8V ;13V; 17V	IEC/EN 60335-2-40 IEC/EN 60335-1	Tested with appliance	

IEC 60335-2-40			
Clause	Requirement + Test	Result - Remark	Verdict

24.1	TABLE: Critical components information					P
Object / part No.	Manufacturer/ trademark	Type / model	Technical data	Standard	Mark(s) of conformity ¹	
Varistor (R01, R02)	WALSIN	SR471K10D	470V; 0.4W	IEC/EN 60335-2-40 IEC/EN 60335-1	VDE	
Varistor (R01, R02) (Alternative)	NIPPON CHEMICON	TNR10V471K	470V; 0.4W	IEC/EN 60335-2-40 IEC/EN 60335-1	VDE	
Varistor (R01, R02) (Alternative)	EPCOS	S10K300E2	470V; 0.4W	IEC/EN 60335-2-40 IEC/EN 60335-1	VDE	
Line Filter (L01, L02)	VRK	VRKR25	2.0mH; 12A	IEC/EN 60335-2-40 IEC/EN 60335-1	Tested with appliance	
Line Filter (L01, L02) (Alternative)	TNC	25A2020	2.0mH; 12A	IEC/EN 60335-2-40 IEC/EN 60335-1	Tested with appliance	
Line Filter (L01, L02) (Alternative)	DMC	GET-04052	2.0mH; 10A	IEC/EN 60335-2-40 IEC/EN 60335-1	Tested with appliance	
Line Filter (L01, L02) (Alternative)	UENO	ADR2510	2.0mH; 10A	IEC/EN 60335-2-40 IEC/EN 60335-1	Tested with appliance	
Capacitor (C01, C06)	OKAYA	LE105	1 μ F; AC 310V; X2	IEC/EN 60384-14	SEMKO	
Capacitor (C01, C06) (Alternative)	ARCOTRON ICS	R46	1 μ F; AC 275V; X2	IEC/EN 60384-14	VDE	
Capacitor (C01, C06) (Alternative)	Nissei Electric	R46(KN)	1 μ F; AC 275V; X2	IEC/EN 60384-14	VDE	
Capacitor (C01, C06) (Alternative)	EUROTRON IC	MPX2	1 μ F; AC 275V; X2	IEC/EN 60384-14	VDE	
Capacitor (C01, C06) (Alternative)	BM	MKP	1 μ F; AC 310V; X2	IEC/EN 60384-14	VDE, CQC	
Capacitor (C02, C05)	OKAYA	YF223	0.022 μ F; AC250V	IEC/EN 60384-14	VDE	
Capacitor (C02, C05) (Alternative)	MURATA	KH, KY	0.022 μ F; AC 250V	IEC/EN 60384-14	VDE	
Capacitor (C07)	NICHICON	LQ	760 μ F; 400V;	IEC/EN 60335-2-40 IEC/EN 60335-1	Tested with appliance	

IEC 60335-2-40			
Clause	Requirement + Test	Result - Remark	Verdict

24.1	TABLE: Critical components information					P
Object / part No.	Manufacturer/ trademark	Type / model	Technical data	Standard	Mark(s) of conformity ¹	
Capacitor (C07) (Alternative)	NIPPON CHEMI-CON	CE	760µF; 400V;	IEC/EN 60335-2-40 IEC/EN 60335-1	Tested with appliance	
Relay (RY01)	SONG CHUAN	891P-1A-C	20A; 12VDC; 250VAC	IEC/EN 61810-1 IEC/EN 60335-2-40 IEC/EN 60335-1 IEC/EN 60079-15	TUV& Tested with appliance	
Relay (RY01) (Alternative)	OMRON	G4A-1A-PE- CA	20A; 12VDC; 250VAC	IEC/EN 61810-1 IEC/EN 60335-2-40 IEC/EN 60335-1 IEC/EN 60079-15	VDE& Tested with appliance	
Relay (RY72)	OMRON	G5NB-14,	5A; 12VDC; 250VAC	IEC/EN 61810-1 IEC/EN 60335-2-40 IEC/EN 60335-1 IEC/EN 60079-15	VDE& Tested with appliance	
Components for Printed circuit board model: WP-030						
Fuse (F01)	NIPPON SEISEN	GDT	25A; 250VAC	IEC/EN 60335-2-40 IEC/EN 60335-1	Tested with appliance	
Fuse (F01) (Alternative)	SOC	CES15, 25A	25A; 250VAC	IEC/EN 60335-2-40 IEC/EN 60335-1	Tested with appliance	
Fuse (F02)	PICO	SCT	3,15A; 250VAC	IEC/EN 60127-2	SEMKO, VDE	
Fuse (F02) (Alternative)	NIPPON SEISEN	FJL	3,15A; 250VAC	IEC/EN 60127-2	SEMKO	
Fuse (F02) (Alternative)	SOC	ET	3,15A; 250VAC	IEC/EN 60127-2	SEMKO	
Varistor (R01), (R02)	NIPPON CHEMI-CON	TNR14V471K 372	470V; 0.4W	IEC/EN 60335-2-40 IEC/EN 60335-1	Tested with appliance	
Line Filter (L01, L02)	TNC	CV25A2020	2.0mH; 12A	IEC/EN 60335-2-40 IEC/EN 60335-1	Tested with appliance	
Line Filter (L01, L02) (Alternative)	DMC	GET-04052	2.0mH; 10A	IEC/EN 60335-2-40 IEC/EN 60335-1	Tested with appliance	
Line Filter (L01, L02) (Alternative)	UENO	ADR2510	2.0mH; 10A	IEC/EN 60335-2-40 IEC/EN 60335-1	Tested with appliance	
Line Filter (L01, L02) (Alternative)	VRK	VRKR-25	2.0mH; 10A	IEC/EN 60335-2-40 IEC/EN 60335-1	Tested with appliance	
Capacitor (C01), (C06)	OKAYA	LE105	1µF; AC 310V	IEC/EN 60384-14	SEMKO	
Capacitor (C01), (C06) (Alternative)	ARCOTRON ICS (Nissei Electric)	R46	1µF; AC 275V	IEC/EN 60384-14	VDE	

IEC 60335-2-40			
Clause	Requirement + Test	Result - Remark	Verdict

24.1	TABLE: Critical components information					P
Object / part No.	Manufacturer/ trademark	Type / model	Technical data	Standard	Mark(s) of conformity ¹	
Capacitor (C01), (C06) (Alternative)	BM	MKP	1µF; AC 310V	IEC/EN 60384-14	VDE, CQC	
Capacitor (C07, C08)	NICHICON	LQ	760µF; 400V; 500µF; 400V	IEC/EN 60335-2-40 IEC/EN 60335-1	Tested with appliance	
Capacitor (C07, C08) (Alternative)	NIPPON CHEMI-CON	CE	760µF; 400V; 500µF; 400V	IEC/EN 60335-2-40 IEC/EN 60335-1	Tested with appliance	
Relay (RY72)	OMRON	G5NB-1A	12VDC; 3A; 250VAC	IEC/EN 61810-1 IEC/EN 60335-2-40 IEC/EN 60335-1 IEC/EN 60079-15	VDE & Tested with appliance	
Relay (RY72) (Alternative)	PANASONI C	ALDP112W	12VDC; 3A; 250VAC	IEC/EN 61810-1 IEC/EN 60335-2-40 IEC/EN 60335-1 IEC/EN 60079-15	VDE & Tested with appliance	
Switching Transformer (T101)	TDK	ST-04	Input: AC176-276; Output: 8V; 13V; 17V	IEC/EN 60335-2-40 IEC/EN 60335-1	Tested with appliance	
Components for indoor model: RAS-B10J2KVRG-E, RAS-B13J2KVRG-E, RAS-B16J2KVRG-E, RAS-18J2KVRG-E, RAS-B22J2KVRG-E, RAS-B24J2KVRG-E, RAS-10J2KVRG-TR, RAS-13J2KVRG-TR, RAS-16J2KVRG-TR, RAS-18J2KVRG-TR, RAS-22J2KVRG-TR, RAS-24J2KVRG-TR, RAS-24PKVSG-EE						
Fan Motor	NIDEC	ICF-340-30-6	DC340V; 42W; Class E	IEC/EN 60335-2-40 IEC/EN 60335-1	Tested with appliance	
Fan Motor (Alternative)	DYNA RECHI	DRM-340-30-2	DC340V; 30W; Class E	IEC/EN 60335-2-40 IEC/EN 60335-1	Tested with appliance	
Fan Motor (Alternative)	NIDEC	ICF-340U30-2	DC340V; 30W; Class E	IEC/EN 60335-2-40 IEC/EN 60335-1	Tested with appliance	
Fan Motor (Alternative)	PANASONI C	MF-340-30-3	DC340V; 30W; Class E	IEC/EN 60335-2-40 IEC/EN 60335-1	Tested with appliance	
Fan Motor (Alternative)	PANASONI C	MF-340-30-4	DC340V; 30W; Class E	IEC/EN 60335-2-40 IEC/EN 60335-1	Tested with appliance	
Fan Motor (Alternative)	PANASONI C	MF-340-30-1RT	DC340V; 30W; Class E	IEC/EN 60335-2-40 IEC/EN 60335-1	Tested with appliance	
Terminal Block	JINLONG	JXO-E3-5P-B-1	5P; AC 300V; 20A	IEC/EN 60335-2-40 IEC/EN 60335-1	Tested with appliance	
Terminal Block (Alternative)	HOPPY	HP-T3	5P; AC 250V; 20A	IEC/EN 60335-2-40 IEC/EN 60335-1	Tested with appliance	
Louver Motor	LEILI	24BYJ48-ST	12VDC	IEC/EN 60335-2-40 IEC/EN 60335-1	Tested with appliance	

IEC 60335-2-40			
Clause	Requirement + Test	Result - Remark	Verdict

24.1	TABLE: Critical components information					P
Object / part No.	Manufacturer/ trademark	Type / model	Technical data	Standard	Mark(s) of conformity ¹)	
Louver Motor (Alternative)	HEFEI	24BYJ48A-080, 24BYJ48-HT, 24BYJ48-HTP	12VDC	IEC/EN 60335-2-40 IEC/EN 60335-1	Tested with appliance	
Louver Motor (Alternative)	NIDEC	MSBPC20F04	12VDC	IEC/EN 60335-2-40 IEC/EN 60335-1	Tested with appliance	
Print Circuit Board (For 10k, 13k, 16k, 18k, 22k, 24k models)	TOSHIBA	WP-048	Material: Paper base Phenolic resin	IEC/EN 60335-2-40 IEC/EN 60335-1	Tested with appliance	
Print Circuit Board (For 24PKVSG-EE model)	TOSHIBA	WP-038	Material: Paper base Phenolic resin	IEC/EN 60335-2-40 IEC/EN 60335-1	Tested with appliance	
Components for Printed circuit board model: WP-048						
Fuse (F01)	NIPPON SEISEN(NFS)	FJL, SLT	6,3A; 250VAC	IEC/EN 60127-2	SEMKO	
Fuse(F01) (Alternative)	SOC	ET, TSCR	6,3A; 250VAC	IEC/EN 60127-2	SEMKO	
Fuse(F01)	NIPPON SEISEN (NFS)	FSL	1,0A; 250VAC	IEC/EN 60127-2	SEMKO	
Switching Transformer (T01)	TDK	ST-05	Input: DC310-340V ; Output: 8V;13V; 19V	IEC/EN 60335-2-40 IEC/EN 60335-1	Tested with appliance	
Varistor (R01)	NIPPON CHEMI-CON	TNR14V561K	560V; 0,6W	IEC/EN 61051-1 IEC/EN 61051-2	Tested with appliance	
Varistor (R01) (Alternative)	WALSIN	SR561K14D	560V; 0,6W	IEC/EN 60335-2-40 IEC/EN 60335-1	VDE	
Varistor (R01) (Alternative)	EPCOS	S14K300E2	470V; 0,6W	IEC/EN 60335-2-40 IEC/EN 60335-1	VDE	
Line Filter (L01)	TOKIN	SS11V- R08125	12,5Mh; 0,8A	IEC/EN 60335-2-40 IEC/EN 60335-1	Tested with appliance	
Capacitor (C01)	NIPPON CHEMI-CON	R46	0,033μF; AC275V	IEC/EN 60384-14	VDE	
Capacitor (C02)	OKAYA	LE224	0,22μF; 310VAC	IEC/EN 60384-14	SEMKO	
Fuse (F01)	NIPPON SEISEN (NFS)	FJL, SLT	6.3A; 250VAC	IEC/EN 60127-2	SEMKO	
Fuse(F01) (Alternative)	SOC	ET, TSCR	6.3A; 250VAC	IEC/EN 60127-2	SEMKO	

IEC 60335-2-40			
Clause	Requirement + Test	Result - Remark	Verdict

24.1	TABLE: Critical components information					P
Object / part No.	Manufacturer/ trademark	Type / model	Technical data	Standard	Mark(s) of conformity ¹	
Fuse (F01)	NIPPON SEISEN (NFS)	FSL	1.0A; 250VAC	IEC/EN 60127-2	SEMKO	
Switching Transformer (T01)	TDK	ST-05	Input:DC310-340V; Output:8V;13V; 19V	IEC/EN 60335-2-40 IEC/EN 60335-1	Tested with appliance	
Varistor (R01)	NIPPON CHEMI-CON	TNR14V561K	560V; 0.6W	IEC/EN 61051-1, IEC/EN 61051-2	Tested with appliance	
Components for Printed circuit board model: WP-038						
Fuse (F01)	NIPPON SEISEN	SLT, FJL	25A, 250VAC	IEC 60127-2	SEMKO	
Fuse (F02, F03)	SOC	TSCR	3.15A, 250VAC	IEC 60127-2	SEMKO	
Switching Transformer (T01)	TDK	ST-05	Input: DC310-340V Output: 8V; 13V; 19V	IEC/EN 60335-2-40 IEC/EN 60335-1	Tested with appliance	
Varistor (R01, R02)	WALSIN	SR471K10D	470V; 0.4W	IEC/EN 60335-2-40 IEC/EN 60335-1	Tested with appliance	
Varistor (R01, R02) (Alternative)	NIPPON CHEMI-CON	TNR10V471K	470V; 0.4W	IEC/EN 60335-2-40 IEC/EN 60335-1	Tested with appliance	
Varistor (R01, R02) (Alternative)	EPCOS	S10K300E2	470V; 0.4W	IEC/EN 60335-2-40 IEC/EN 60335-1	Tested with appliance	
Line Filter (L01)	TOKIN	SS11V- R06270	27mH; 0.6A	IEC/EN 60335-2-40 IEC/EN 60335-1	Tested with appliance	
Capacitor (C01)	OKAYA	LE224	0.22µF; AC310V	IEC/EN 60384-14	VDE	
Capacitor (C01) (Alternative)	EUROTRON IC	MPX2	0.22µF; AC275V	IEC/EN 60384-14	VDE	
Capacitor (C01) (Alternative)	Nissei Electric	R46	0.22µF; AC275V	IEC/EN 60384-14	VDE	
Capacitor (C01) (Alternative)	BM	MKP	0.22µF; AC310V	IEC/EN 60384-14	VDE, CQC	
Capacitor (C02)	OKAYA	LE224	0.22µF; AC310V	IEC/EN 60384-14	SEMKO	
Capacitor (C02) (Alternative)	BM	MKP	0.22µF; AC310V	IEC/EN 60384-14	VDE, CQC	
Capacitor (C03)	ELNA	LAH	150µF; 450V	IEC/EN 60384-14	VDE	
Capacitor (C03) (Alternative)	NIPPON CHEMI-CON	KMH	150µF; 450V	IECEN 60384-14	VDE	
Relay (RY01)	SCN	891WP-1AC	20A; 250VAC	IEC/EN 61810-1 IEC/EN 60335-2-40 IEC/EN 60335-1 IEC/EN 60079-15	TUV& Tested with appliance	

IEC 60335-2-40			
Clause	Requirement + Test	Result - Remark	Verdict

24.1	TABLE: Critical components information					P
Object / part No.	Manufacturer/ trademark	Type / model	Technical data	Standard	Mark(s) of conformity ¹⁾	
Relay (RY01) (Alternative)	OMRON	G4A-1A-E	20A; 250VAC	IEC/EN 61810-1 IEC/EN 60335-2-40 IEC/EN 60335-1 IEC/EN 60079-15	VDE & Tested with appliance	
Supplementary information: 1) Provided evidence ensures the agreed level of compliance. See OD-CB2039.						

28.1	TABLE: Threaded part torque test			P
Threaded part identification	Diameter of thread (mm)	Column number (I, II, or III)	Applied torque (Nm)	
Earth screw	3,86	II	1,2	
Terminal screw	3,86	II	1,2	
Supplementary information: N/A				

29.1	TABLE: Clearances					P
	Overvoltage category		II		—	
	Type of insulation:					
Rated impulse voltage (V):	Min. cl (mm)	Basic (mm)	Supplementary (mm)	Reinforced (mm)	Functional (mm)	Verdict / Remark
330	0,2* / 0,5 / 0,8**	—	—	—	—	N/A
500	0,2* / 0,5 / 0,8**	—	—	—	—	N/A
800	0,2* / 0,5 / 0,8**	—	—	—	—	N/A
1 500	0,5 / 0,8** / 1,0***	—	—	—	—	N/A
2 500	1,5 / 2,0***	9,0	5,3	—	9,0	P
4 000	3,0 / 3,5***	—	—	11,0	—	P
6 000	5,5 / 6,0***	—	—	—	—	N/A
8 000	8,0 / 8,5***	—	—	—	—	N/A
10 000	11,0 / 11,5***	—	—	—	—	N/A
Supplementary information: *) For tracks on printed circuit boards if pollution degree 1 and 2 **) For pollution degree 3 ***) If the construction is affected by wear, distortion, movement of the parts or during assembly						

IEC 60335-2-40			
Clause	Requirement + Test	Result - Remark	Verdict

29.2	TABLE: Creepage distances, basic, supplementary and reinforced insulation										P
Working voltage (V)	Creepage distance (mm) Pollution degree							Type of insulation			Verdict
	1	2			3						
		Material group			Material group						
		I	II	IIIa/IIIb	I	II	IIIa/IIIb*	B**	S**	R**	
≤50	0,18	0,6	0,85	1,2	1,5	1,7	1,9		—	—	N/A
≤50	0,18	0,6	0,85	1,2	1,5	1,7	1,9	—		—	N/A
≤50	0,36	1,2	1,7	2,4	3,0	3,4	3,8	—	—		N/A
125	0,28	0,75	1,05	1,5	1,9	2,1	2,4		—	—	N/A
125	0,28	0,75	1,05	1,5	1,9	2,1	2,4	—		—	N/A
125	0,56	1,5	2,1	3,0	3,8	4,2	4,8	—	—		N/A
250	0,56	1,25	1,8	2,5	3,2	3,6	4,0	9,0	—	—	P
250	0,56	1,25	1,8	2,5	3,2	3,6	4,0	—	8,3	—	P
250	1,12	2,5	3,6	5,0	6,4	7,2	8,0	—	—	15,0	P
400	1,0	2,0	2,8	4,0	5,0	5,6	6,3		—	—	N/A
400	1,0	2,0	2,8	4,0	5,0	5,6	6,3	—		—	N/A
400	2,0	4,0	5,6	8,0	10,0	11,2	12,6	—	—		N/A
500	1,3	2,5	3,6	5,0	6,3	7,1	8,0		—	—	N/A
500	1,3	2,5	3,6	5,0	6,3	7,1	8,0	—		—	N/A
500	2,6	5,0	7,2	10,0	12,6	14,2	16,0	—	—		N/A
>630 and ≤800	1,8	3,2	4,5	6,3	8,0	9,0	10,0		—	—	N/A
>630 and ≤800	1,8	3,2	4,5	6,3	8,0	9,0	10,0	—		—	N/A
>630 and ≤800	3,6	6,4	9,0	12,6	16,0	18,0	20,0	—	—		N/A
>800 and ≤1000	2,4	4,0	5,6	8,0	10,0	11,0	12,5		—	—	N/A
>800 and ≤1000	2,4	4,0	5,6	8,0	10,0	11,0	12,5	—		—	N/A
>800 and ≤1000	4,8	8,0	11,2	16,0	20,0	22,0	25,0	—	—		N/A
>1000 and ≤1250	3,2	5,0	7,1	10,0	12,5	14,0	16,0		—	—	N/A
>1000 and ≤1250	3,2	5,0	7,1	10,0	12,5	14,0	16,0	—		—	N/A
>1000 and ≤1250	6,4	10,0	14,2	20,0	25,0	28,0	32,0	—	—		N/A
>1250 and ≤1600	4,2	6,3	9,0	12,5	16,0	18,0	20,0		—	—	N/A
>1250 and ≤1600	4,2	6,3	9,0	12,5	16,0	18,0	20,0	—		—	N/A
>1250 and ≤1600	8,4	12,6	18,0	25,0	32,0	36,0	40,0	—	—		N/A
>1600 and ≤2000	5,6	8,0	11,0	16,0	20,0	22,0	25,0		—	—	N/A

TRF No. IEC60335_2_400

1285/5 Prachachuen Rd., Wongsawang, Bangsue, Bangkok 10800 THAILAND

Tel : +66 2 765 2888 Fax : +66 2 765 2889

www.intertek.com

IEC 60335-2-40			
Clause	Requirement + Test	Result - Remark	Verdict

29.2	TABLE: Creepage distances, basic, supplementary and reinforced insulation										P
Working voltage (V)	Creepage distance (mm) Pollution degree							Type of insulation			Verdict
	1	2			3						
		Material group			Material group						
		I	II	IIIa/IIIb	I	II	IIIa/IIIb*	B**	S**	R**	
>1600 and ≤2000	5,6	8,0	11,0	16,0	20,0	22,0	25,0	—	—	—	N/A
>1600 and ≤2000	11,2	16,0	22,0	32,0	40,0	44,0	50,0	—	—	—	N/A
>2000 and ≤2500	7,5	10,0	14,0	20,0	25,0	28,0	32,0	—	—	—	N/A
>2000 and ≤2500	7,5	10,0	14,0	20,0	25,0	28,0	32,0	—	—	—	N/A
>2000 and ≤2500	15,0	20,0	28,0	40,0	50,0	56,0	64,0	—	—	—	N/A
>2500 and ≤3200	10,0	12,5	18,0	25,0	32,0	36,0	40,0	—	—	—	N/A
>2500 and ≤3200	10,0	12,5	18,0	25,0	32,0	36,0	40,0	—	—	—	N/A
>2500 and ≤3200	20,0	25,0	36,0	50,0	64,0	72,0	80,0	—	—	—	N/A
>3200 and ≤4000	12,5	16,0	22,0	32,0	40,0	45,0	50,0	—	—	—	N/A
>3200 and ≤4000	12,5	16,0	22,0	32,0	40,0	45,0	50,0	—	—	—	N/A
>3200 and ≤4000	25,0	32,0	44,0	64,0	80,0	90,0	100,0	—	—	—	N/A
>4000 and ≤5000	16,0	20,0	28,0	40,0	50,0	56,0	63,0	—	—	—	N/A
>4000 and ≤5000	16,0	20,0	28,0	40,0	50,0	56,0	63,0	—	—	—	N/A
>4000 and ≤5000	32,0	40,0	56,0	80,0	100,0	112,0	126,0	—	—	—	N/A
>5000 and ≤6300	20,0	25,0	36,0	50,0	63,0	71,0	80,0	—	—	—	N/A
>5000 and ≤6300	20,0	25,0	36,0	50,0	63,0	71,0	80,0	—	—	—	N/A
>5000 and ≤6300	40,0	50,0	72,0	100,0	126,0	142,0	160,0	—	—	—	N/A
>6300 and ≤8000	25,0	32,0	45,0	63,0	80,0	90,0	100,0	—	—	—	N/A
>6300 and ≤8000	25,0	32,0	45,0	63,0	80,0	90,0	100,0	—	—	—	N/A
>6300 and ≤8000	50,0	64,0	90,0	126,0	160,0	180,0	200,0	—	—	—	N/A
>8000 and ≤10000	32,0	40,0	56,0	80,0	100,0	110,0	125,0	—	—	—	N/A
>8000 and ≤10000	32,0	40,0	56,0	80,0	100,0	110,0	125,0	—	—	—	N/A
>8000 and ≤10000	64,0	80,0	112,0	160,0	200,0	220,0	250,0	—	—	—	N/A
>10000 and ≤12500	40,0	50,0	71,0	100,0	125,0	140,0	160,0	—	—	—	N/A
>10000 and ≤12500	40,0	50,0	71,0	100,0	125,0	140,0	160,0	—	—	—	N/A
>10000 and ≤12500	80,0	100,0	142,0	200,0	250,0	280,0	320,0	—	—	—	N/A

IEC 60335-2-40			
Clause	Requirement + Test	Result - Remark	Verdict

29.2	TABLE: Creepage distances, basic, supplementary and reinforced insulation										P	
Working voltage (V)	Creepage distance (mm) Pollution degree									Type of insulation		Verdict
	1	2			3							
		Material group			Material group							
		I	II	IIIa/IIIb	I	II	IIIa/IIIb*	B**	S**	R**		
Supplementary information:												
*) Material group IIIb is allowed if the working voltage does not exceed 50 V												
**) B = Basic insulation, S = Supplementary insulation, R = Reinforced insulation												

IEC 60335-2-40			
Clause	Requirement + Test	Result - Remark	Verdict

29.2	TABLE: Creepage distances, functional insulation							P
Working voltage (V)	Creepage distance (mm) Pollution degree							Verdict / Remark
	1	2			3			
		Material group			Material group			
		I	II	IIIa/IIIb	I	II	IIIa/IIIb*	
≤10	0,08	0,4	0,4	0,4	1,0	1,0	1,0	N/A
50	0,16	0,56	0,8	1,1	1,4	1,6	1,8	P
125	0,25	0,71	1,0	1,4	1,8	2,0	2,2	N/A
250	0,42	1,0	1,4	2,0	2,5	2,8	3,2	P
400	0,75	1,6	2,2	3,2	4,0	4,5	5,0	N/A
500	1,0	2,0	2,8	4,0	5,0	5,6	6,3	N/A
>630 and ≤800	1,8	3,2	4,5	6,3	8,0	9,0	10,0	N/A
>800 and ≤1000	2,4	4,0	5,6	8,0	10,0	11,0	12,5	N/A
>1000 and ≤1250	3,2	5,0	7,1	10,0	12,5	14,0	16,0	N/A
>1250 and ≤1600	4,2	6,3	9,0	12,5	16,0	18,0	20,0	N/A
>1600 and ≤2000	5,6	8,0	11,0	16,0	20,0	22,0	25,0	N/A
>2000 and ≤2500	7,5	10,0	14,0	20,0	25,0	28,0	32,0	N/A
>2500 and ≤3200	10,0	12,5	18,0	25,0	32,0	36,0	40,0	N/A
>3200 and ≤4000	12,5	16,0	22,0	32,0	40,0	45,0	50,0	N/A
>4000 and ≤5000	16,0	20,0	28,0	40,0	50,0	56,0	63,0	N/A
>5000 and ≤6300	20,0	25,0	36,0	50,0	63,0	71,0	80,0	N/A
>6300 and ≤8000	25,0	32,0	45,0	63,0	80,0	90,0	100,0	N/A
>8000 and ≤10000	32,0	40,0	56,0	80,0	100,0	110,0	125,0	N/A
>10000 and ≤12500	40,0	50,0	71,0	100,0	125,0	140,0	160,0	N/A

Supplementary information:
*) Material group IIIb is allowed if the working voltage does not exceed 50 V

IEC 60335-2-40			
Clause	Requirement + Test	Result - Remark	Verdict

30.1	TABLE: Ball Pressure Test of Thermoplastics			P
Allowed impression diameter (mm)			≤2,0	—
Object/ Part No./ Material	Manufacturer/ trademark	Type/Model	Test temperature (°C)	Impression diameter (mm)
Terminal block	JINLONG	JXO-5B	125	1,4
Terminal block	JINLONG	JXO-E3-5P-B-1	125	1,3
Terminal block	HOPPY	HP-T3	125	1,2
Switching transformer (T01)	TDK	ST-05	125	1,2
Switching transformer (T101)	TDK	ST-04	125	1,2
4 way Valve	SANHUA	SANHUA	125	1,2
4 way Valve	DUNAN	DXQ	125	1,2
4 way Valve	DUNAN	DFS-4	125	1,1
4 way Valve	SAGINOMIYA	STF, VHV, VPV	125	1,1
Line Filter (L01, L02)	VRK	VRKR25	125	1,3
Line Filter (L01, L02)	TNC	25A2020	125	1,2
Line Filter (L01, L02)	DMC	GET-04052	125	1,4
Line Filter (L01, L02)	UENO	ADR2510	125	1,3
Line filter (L01)	TOKIN	SS11V-R08125	125	1,0
Line filter (L01)	TOKIN	SS11V-R06270	125	1,0
Relay (RY01)	SONG CHUAN	891P-1A-C	125	1,6
Relay (RY72)	OMRON	G5NB-1A	125	1,5
Capacitor (C01, C06)	OKAYA	LE105	125	0,7
Capacitor (C02, C05)	OKAYA	YF223	125	0,4
Line filter (L01, L02)	TNC	25A2020	125	1,4
Line filter (L01)	TOKIN	SS11V-R08125	125	0,9
Reactor	TABUCHI	CH-69	125	1,2
Reactor	DPC	CH-69	125	0,9
Reactor	TABUCHI	CH-51	125	0,9
Reactor	TABUCHI	CH-47	125	1,1

IEC 60335-2-40				
Clause	Requirement + Test		Result - Remark	Verdict
Print circuit board	TOSHIBA	WP-030	125	0,8
Print circuit board	TOSHIBA	WP-032	125	0,8
Print circuit board	TOSHIBA	WP-048	125	0,7
Print circuit board	TOSHIBA	WP-038	125	0,8
Connector of fan motor outdoor	--	--	125	1,4
Connector of fan motor indoor	--	--	125	0,9
Connector of compressor	--	--	125	1,3
Control box	--	--	75	1,4
Supplementary information: N/A				

30.2	TABLE: Resistance to heat and fire - Glow wire tests								P
Object/ Part No./ Material	Manufacturer/ trademark	Type/Model	Glow wire test (GWT); (°C)						Verdict
			550	650		750		850	
				te	ti	te	ti		
Terminal block	JINLONG	JXO-5B	--	--	--	0	0	X	P
Terminal block	JINLONG	JXO-E3-5P-B-1	--	--	--	0	0	X	P
Terminal block	HOPPY	HP-T3	--	--	--	0	0	X	P
Switching transformer (T01)	TDK	ST-05	--	--	--	0	0	X	P
Switching transformer (T101)	TDK	ST-04	--	--	--	0	0	X	P
4 way Valve	SANHUA	SANHUA	--	--	--	0	0	X	P
4 way Valve	DUNAN	DXQ	--	--	--	0	0	X	P
4 way Valve	DUNAN	DFS-4	--	--	--	0	0	X	P
4 way Valve	SAGINOMIYA	STF, VHV, VPV	--	--	--	0	0	X	P
Line Filter (L01, L02)	VRK	VRKR25	--	--	--	0	0	X	P
Line Filter (L01, L02)	TNC	25A2020	--	--	--	0	0	X	P
Line Filter (L01, L02)	DMC	GET-04052	--	--	--	0	0	X	P
Line Filter (L01, L02)	UENO	ADR2510	--	--	--	0	0	X	P
Line filter (L01)	TOKIN	SS11V-R08125	--	--	--	0	0	X	P

IEC 60335-2-40									
Clause	Requirement + Test					Result - Remark			Verdict
Line filter (L01)	TOKIN	SS11V-R06270	--	--	--	0	0	X	P
Relay (RY01)	SONG CHUAN	891P-1A-C	--	--	--	0	0	X	P
Relay (RY72)	OMRON	G5NB-1A	--	--	--	0	0	X	P
Capacitor (C01, C06)	OKAYA	LE105	--	--	--	1,0	0,3	X	P
Capacitor (C02, C05)	OKAYA	YF223	--	--	--	0	0	X	P
Line filter (L01, L02)	TNC	25A2020	--	--	--	0	0	X	P
Line filter (L01)	TOKIN	SS11V-R08125	--	--	--	0	0	X	P
Reactor	TABUCHI	CH-69	--	--	--	0	0	X	P
Reactor	DPC	CH-69	--	--	--	0	0	X	P
Reactor	TABUCHI	CH-51	--	--	--	0	0	X	P
Reactor	TABUCHI	CH-47	--	--	--	0	0	X	P
Print circuit board	TOSHIBA	WP-030	--	--	--	0	0	X	P
Print circuit board	TOSHIBA	WP-032	--	--	--	0	0	X	P
Print circuit board	TOSHIBA	WP-048	--	--	--	0	0	X	P
Print circuit board	TOSHIBA	WP-038	--	--	--	0	0	X	P
Connector of fan motor outdoor	--	--	--	--	--	30,6	0,4	X	P
Connector of fan motor indoor	--	--	--	--	--	32,8	20,0	X	P
Connector of compressor	--	--	--	--	--	23,6	0,5	X	P
Control box	--	--	X	--	--	--	--	--	P
The test specimen passed the glow wire test (GWT) with no ignition $[(t_e - t_i) \leq 2s]$ (Yes/No):									No
If no, then surrounding parts passed the needle-flame test of annex E (Yes/No)..... :									Yes
The test specimen passed the test by virtue of most of the flaming material being withdrawn with the glow-wire (Yes/No)?									No
Ignition of the specified layer placed underneath the test specimen (Yes/No)									No
Supplementary information: - 550 °C GWT not relevant (or applicable) to parts of material classified at least HB40 or if relevant HBF - The GWIT pre-selection option, the 850 °C GWFI pre-selection option, and the 850 °C GWT are not relevant (or applicable) for attended appliances									

IEC 60335-2-40			
Clause	Requirement + Test	Result - Remark	Verdict

30.2/30.2.4	TABLE: Needle- flame test (NFT)				P
Object/ Part No./ Material	Manufacturer/ trademark	Duration of application of test flame (ta); (s)	Ignition of specified layer Yes/No	Duration of burning (tb) (s)	Verdict
Print circuit board WP-030	TOSHIBA	30	No	0	P
Print circuit board WP-032	TOSHIBA	30	No	0	P
Print circuit board WP-048	TOSHIBA	30	No	0	P
Print circuit board WP-038	TOSHIBA	30	No	0	P
Control box	--	30	No	2	P
Supplementary information:					
- NFT not relevant (or applicable) for Parts of material classified as V-0 or V-1					
- NFT not relevant (or applicable) for Base material of PCBs classified as V-0 or if relevant VTM-0					

Appendix EMF	RAS-10J2AVRG-E/ RAS-10J2KVRG-E		P
	TEST: Evaluation of the magnetic fields		
Applied standards:	IEC 62233:2005, EN 62233:2008 (incl. Corr.1:2008)		
Method	Used method: 5.5.2 Time domain evaluation		—
Applied Limit	ICNIRP Guidelines		—
Identification of the appliance	Type of apparatus	Split Type Air Conditioners	
	Rated Voltage	220-240V	
	Rated Frequency	50Hz	
Parameters required prior to the test	Laboratory Ambient Temperature	25 °C ± 10 °C	
	Supply Voltage	(Rated Voltage ± 2 %) V	
	Supply Frequency	(Rated Frequency ± 2 %) Hz	
Parameters recorded during the test	Laboratory Ambient Temperature	30/15 °C	
	Supply Voltage	230V	
	Supply Frequency	50Hz	
Operating Mode	--		
Method 5.5.2			
Measuring Positions	Measuring Distance	Coupling Factor	Measurement Uncertainty
Round	30	0,18	N/A
Frequency (kHz)	Limit (%)	Measured Maximum Value (%)	

IEC 60335-2-40			
Clause	Requirement + Test	Result - Remark	Verdict
0,01 to 400		100	13,5 %
Supplementary information: The measured maximum value in this table may be weighted with the coupling factor if applicable, and the measurement uncertainty is applied if the measured result is more than 75 % of the limit.			

IEC 60335-2-40			
Clause	Requirement + Test	Result - Remark	Verdict

Appendix EMF	RAS-16J2AVRG-E/ RAS-16J2KVRG-E			P
	TEST: Evaluation of the magnetic fields			
Applied standards:	IEC 62233:2005, EN 62233:2008 (incl. Corr.1:2008)			
Method	Used method: 5.5.2 Time domain evaluation			—
Applied Limit	ICNIRP Guidelines			—
Identification of the appliance	Type of apparatus	Split Type Air Conditioners		
	Rated Voltage	220-240V		
	Rated Frequency	50Hz		
Parameters required prior to the test	Laboratory Ambient Temperature	25 °C ± 10 °C		
	Supply Voltage	(Rated Voltage ± 2 %) V		
	Supply Frequency	(Rated Frequency ± 2 %) Hz		
Parameters recorded during the test	Laboratory Ambient Temperature	30/15 °C		
	Supply Voltage	230V		
	Supply Frequency	50Hz		
Operating Mode	--			
Method 5.5.2				
Measuring Positions	Measuring Distance	Coupling Factor	Measurement Uncertainty	
Round	30	0,18	N/A	
Frequency (kHz)	Limit (%)	Measured Maximum Value (%)		
0,01 to 400	100	25,5 %		
Supplementary information:				
The measured maximum value in this table may be weighted with the coupling factor if applicable, and the measurement uncertainty is applied if the measured result is more than 75 % of the limit.				

IEC 60335-2-40			
Clause	Requirement + Test	Result - Remark	Verdict

Appendix EMF	RAS-24J2AVRG-E/ RAS-24J2KVRG-E			P
	TEST: Evaluation of the magnetic fields			
Applied standards:	IEC 62233:2005, EN 62233:2008 (incl. Corr.1:2008)			
Method	Used method: 5.5.2 Time domain evaluation			—
Applied Limit	ICNIRP Guidelines			—
Identification of the appliance	Type of apparatus	Split Type Air Conditioners		
	Rated Voltage	220-240V		
	Rated Frequency	50Hz		
Parameters required prior to the test	Laboratory Ambient Temperature	25 °C ± 10 °C		
	Supply Voltage	(Rated Voltage ± 2 %) V		
	Supply Frequency	(Rated Frequency ± 2 %) Hz		
Parameters recorded during the test	Laboratory Ambient Temperature	30/15 °C		
	Supply Voltage	230V		
	Supply Frequency	50Hz		
Operating Mode	--			
Method 5.5.2				
Measuring Positions	Measuring Distance	Coupling Factor	Measurement Uncertainty	
Round	30	0,18	N/A	
Frequency (kHz)	Limit (%)	Measured Maximum Value (%)		
0,01 to 400	100	13,0 %		
Supplementary information:				
The measured maximum value in this table may be weighted with the coupling factor if applicable, and the measurement uncertainty is applied if the measured result is more than 75 % of the limit.				

IEC 60335-2-40			
Clause	Requirement + Test	Result - Remark	Verdict

ATTACHMENT TO TEST REPORT IEC 60335-2-40 EUROPEAN GROUP DIFFERENCES AND NATIONAL DIFFERENCES Part-2-40: Particular requirements for electrical heat pumps, air conditioners and dehumidifiers	
Differences according to	: EN 60335-2-40:2003 (incl. Corr.:2006) + A11:2004 + A12:2005 + A1:2006 + A2:2009 + A13:2012 (incl. Corr.:2013) EN 60335-1:2012 (incl. Corr.:2014)
Attachment Form No.	: EU_GD_IEC60335_2_40H
Attachment Originator:	VDE
Master Attachment	: 2014-02
Copyright © 2014 IEC System for Conformity Testing and Certification of Electrical Equipment (IECEE), Geneva, Switzerland. All rights reserved.	

CENELEC COMMON MODIFICATIONS			
6.1	Delete "class 0" and "class 01"	Class I	Noted
7.1	Single-phase appliances to be connected to the supply mains: 230 V covered	220-240V	P
	Multi-phase appliances to be connected to the supply mains: 400 V covered		N/A
7.10	Devices used to start/stop operational functions of the appliance distinguished from other manual devices by means of shape, size, surface texture, position, etc.		P
	An indication that the device has been operated is given by:		P
	- a tactile feedback, or		N/A
	- an audible and visual feedback		P
7.12	The instructions include the substance of the following:		—
	- this appliance can be used by children aged from 8 years and above and persons with reduced physical, sensory or mental capabilities or lack of experience and knowledge if they have been given supervision or instruction concerning use of the appliance in a safe way and understand the hazards involved		P
	- children shall not play with the appliance		P
	- cleaning and user maintenance shall not be made by children without supervision		P
7.12.1	Installation instructions for appliances intended to be permanently connected to fixed wiring, and have leakage current exceed 10 mA, state that installation of residual current device (RCD) having rated residual operating current not exceeding 30 mA is advisable (EN 60335-2-40)		N/A

IEC 60335-2-40			
Clause	Requirement + Test	Result - Remark	Verdict
	For appliances not accessible to the general public and which are intended to be permanently connected to fixed wiring and which may have leakage currents exceeding 10 mA, the installation instructions shall specify the rating of the residual current device (RCD) to be installed (EN 60335-2-40/A12)		N/A
7.12.Z1	The specific instructions related to the safe operation of this appliance is collated together in the front section of the user instructions		P
	The height of the characters, measured on the capital letters, is at least 3 mm		P
	These instructions are also available in an alternative format, e.g. on a website	Website	P
8.1.1	Also test probe 18 of EN 61032 is applied		P
	The appliance being in every possible position, except that appliances normally used on the floor and having a mass exceeding 40 kg are not tilted. (EN 60335-1:2012/AC:2014)		P
	The force on the probe in the straight position is increased to 10 N when probe 18 is used		P
	When using test probe 18 the appliance is fully assembled as in normal use without any parts removed, and		P
	parts intended to be removed for user maintenance are also not removed		P
8.2	Compliance is checked by applying the test probes of EN 61032		P
	For built-in appliances and fixed appliances, the test probe B and probe 18 of EN 61032 are applied only after installation		P
11.8	Footnotes to "External enclosure of motor-operated appliances" to be taken into account		P
13.2	Leakage current measurements (EN 60335-2-40)	(See appended table)	P
15.1.2	Appliances with an automatic cord reel tested with the cord in the most unfavourable position so that the reeling of the wet cord may affect electrical insulation during operation, the cord not being dried before reeling		N/A
15.2	Drain pan filled to brim and subjected to continuous overflow and fan(s) switched on (EN 60335-2-40)		N/A
16.2	Leakage current measurements (EN 60335-2-40)	(See appended table)	P
20.2	When using the test probe similar to test probe B with a circular stop face, the accessories and detachable covers are removed		P

IEC 60335-2-40			
Clause	Requirement + Test	Result - Remark	Verdict
	Test probe 18 applied with a force of 2,5 N on the appliance fully assembled		P
24.1	Components comply with the safety requirements specified in the relevant standards as far as they reasonably apply		P
	The requirements of clause 29 of this standard apply between live parts of components and accessible parts of the appliance.		P
	The requirements of 30.2 of this standard apply to parts of non-metallic material in components including parts of non-metallic material supporting current-carrying connections inside components		P
	Components that have not been previously tested or do not comply with the standard for the relevant component are tested according to the requirements of 30.2		P
	Components that have been previously tested and shown to comply with the resistance to fire requirements in the standard for the relevant component need not be retested provided that:		—
	- the severity specified in the component standard is not less than the severity specified in 30.2, and		P
	- the test report for the component states whether it complied with the standard for the relevant component with or without flame, flames not exceeding 2 s during the test are ignored		N/A
	Unless components have been previously tested and found to comply with the relevant standard for the number of cycles specified, they are tested in accordance with 24.1.1 to 24.1.9		P
	For components mentioned in 24.1.1 to 24.1.9, no additional tests specified in the relevant standard for the component are necessary other than those specified in 24.1.1 to 24.1.9		P
	Components that have not been separately tested and found to comply with the relevant standard, and		P
	components that are not marked or not used in accordance with their marking,		P
	are tested in accordance with the conditions occurring in the appliance, the number of samples being that required by the relevant standard		P
	Lamp holders and starter holders that have not been previously tested and found to comply with the relevant standard are tested as a part of the appliance and additionally comply with the gauging and interchangeability requirements of the relevant standard under the conditions occurring in the appliance		N/A

IEC 60335-2-40			
Clause	Requirement + Test	Result - Remark	Verdict
	Where the relevant standard specifies these gauging and interchangeability requirements at elevated temperatures, the temperatures measured during the tests of clause 11 are used		N/A
	Plugs and socket-outlets and other connecting devices of interconnection cords are not interchangeable with plugs and socket-outlets listed in IEC/TR 60083 or IEC 60906-1, or		N/A
	with connectors and appliance inlets complying with the standard sheets of IEC 60320-1,		N/A
	if direct supply to these parts from the supply mains gives rise to a hazard		N/A
24.1.7	If the remote operation of the appliance is via a telecommunication network, the relevant standard for the telecommunication interface circuitry in the appliance is EN 41003		N/A
	Compliance with clause 8 of this standard is not impaired by connecting the appliance to a device covered by EN 41003		N/A
24.Z1	For motor running capacitors (IEC 60252-1 type P2) with a metallic enclosure having an overpressure fuse the flame testing of internal plastic parts supporting current carrying connections as required in 30.2.2 and 30.2.3.1 is not necessary		N/A
25.6	Supply cords of single-phase portable appliances having a rated current not exceeding 16 A, fitted with a plug complying with the following standard sheets of IEC/TR 60083:		---
	- for class I appliances: standard sheet C2b, C3b or C4..... :		N/A
	- for class II appliances: standard sheet C5 or C6		N/A
25.7	Rubber sheathed cords (60245 IEC 53) are not suitable for appliances intended to be used outdoors or when they are liable to be exposed to significant amount of ultraviolet radiation		N/A
	Halogen-free thermoplastic compound sheathed supply cords have properties at least those of:		N/A
	- halogen-free thermoplastic compound sheathed cords (H03Z1Z1H2-F or H03Z1Z1-F), for appliances having a mass not exceeding 3 kg		N/A
	- halogen-free thermoplastic compound sheathed cords (H05Z1Z1H2-F or H05Z1Z1-F), for other appliances		N/A
	Cross-linked halogen-free compound sheathed supply cords have properties at least those of cross-linked halogen-free compound sheathed cords (H07ZZ-F)		N/A

IEC 60335-2-40			
Clause	Requirement + Test	Result - Remark	Verdict
26.11	Conductors connected by soldering are not considered to be positioned or fixed so that reliance is not placed upon the soldering alone to maintain them in position unless they are held in place near the terminals independently of the solder		N/A
29.3.Z1	Appliance constructed so that if there is a possibility of damaging the insulation during installation, the insulation withstands the scratch and penetration test of 21.2		N/A
32	Compliance regarding electromagnetic fields is checked according to EN 62233	<100%	P
GG.2	Requirements for charge limits in unventilated areas (EN 60335-2-40/A1)		N/A
GG.Z1	Non fixed factory sealed single package units with a charge amount of $m_1 < M \leq 2 \times m_1$ (EN 60335-2-40/A1)		N/A
Annex I, 19.I.101	The appliance is supplied at rated voltage and operated under normal operation with each of the fault conditions specified		N/A
	The duration of the test is as specified in 19.7		N/A
ZA	ANNEX ZA (NORMATIVE) SPECIAL NATIONAL CONDITIONS		—
	Norway		—
19.5	The test is also applicable to appliances intended to be permanently connected to fixed wiring		N/A
	Norway		—
22.2	The second paragraph of this subclause, dealing with single-phase, permanently connected class I appliances having heating elements, is not applicable due to the supply system		N/A
	All CENELEC countries		—
25.6 and 25.25	Information concerning National plug and socket-outlets is available from the CENELEC website. Normative national requirements concerning plug and socket-outlets are shown in the relevant National standard		N/A
	Ireland and United Kingdom		—
25.8	In the table, the lines for 10 A and 16 A are replaced by:		
	> 10 and ≤ 13 1,25 (1,0) ^b (EN 60335-1:2012/AC:2014)		P

IEC 60335-2-40			
Clause	Requirement + Test	Result - Remark	Verdict
	> 13 and ≤ 16 1,5 (1,0) ^b (EN 60335-1:2012/AC:2014)		N/A
ZB	ANNEX ZB (INFORMATIVE) A-DEVIATIONS		—
	Ireland		—
25.6	These regulations apply to all plugs for domestic use at a voltage of not less than 200 V and in general allow only plugs complying with I.S. 401:1997, or equivalent, to be fitted to domestic appliances		N/A
	United Kingdom		—
25.6	These regulations apply to all plugs for domestic use at a voltage of not less than 200 V and in general allow only plugs to BS 1363 to be fitted to domestic appliances. It also allows plugs to BS 4573 and EN 50075 to be fitted to shavers and toothbrushes		N/A
ZC	ANNEX ZC (NORMATIVE) NORMATIVE REFERENCES TO INTERNATIONAL PUBLICATIONS WITH THEIR CORRESPONDING EUROPEAN PUBLICATIONS		—
	A list of referenced documents in this standard		P
ZD	ANNEX ZD (INFORMATIVE) IEC and CENELEC CODE DESIGNATIONS FOR FLEXIBLE CORDS		—
	A table with IEC and CENELEC code designations for flexible cords		P
ZE	ANNEX ZE (INFORMATIVE) SPECIFIC ADDITIONAL REQUIREMENTS FOR APPLIANCES AND MACHINES INTENDED FOR COMMERCIAL USE		—
7.1	Business name and full address of the manufacturer and, where applicable, his authorized representative..... :		N/A
	Model or type reference..... :		N/A
	Serial number, if any..... :		N/A
	Production year		N/A
	Designation of the appliance :		N/A

IEC 60335-2-40			
Clause	Requirement + Test	Result - Remark	Verdict
7.12	Instructions provided with the appliance so that the appliance can be used safely		N/A
	The instructions contain at least the following information:		N/A
	- the business name and full address of the manufacturer and, where applicable, his authorized representative		N/A
	- model or type reference of the appliance as marked on the appliance itself, except for the serial number		N/A
	- the designation of the appliance together with its explanation in case it is given by a combination of letters and/or numbers		N/A
	- the general description of the appliance, when needed due to the complexity of the appliance		N/A
	- specific precautions if required during installation, operation, adjusting, user maintenance, cleaning, repairing or moving		N/A
	- when needed drawings, diagrams, descriptions and explanations necessary for the safe use and user maintenance of the appliance		N/A
	- the possible reasonably foreseeable misuse and, whenever relevant, a warning against the effects it may have on the safe use of the appliance		N/A
	The words "Original instructions" appear on the language version(s) verified by the manufacturer or by the authorized representative		N/A
	When a translation of the original instructions has been provided by a person introducing the appliance on the market; the meaning of the sentence "Translation of the original instructions" appear in the relevant instructions delivered with the appliance		N/A
	The instructions for maintenance/service to be done by specialized personnel, mandated by the manufacturer or the authorized representative may be supplied in only one Community language which the specialized personnel understand		N/A
	The instructions indicate the type and frequency of inspections and maintenance required for safe operation including the preventive maintenance measures		N/A
	"This appliance is intended to be used by expert or trained users in shops, in light industry and on farms, or for commercial use by lay persons". (EN 60335-2-40/A13)		N/A
7.12.ZE1	If needed for specific appliances, the following information to be given:		—

IEC 60335-2-40			
Clause	Requirement + Test	Result - Remark	Verdict
	- on use, transportation, assembly, dismantling when out of service, testing or foreseeable breakdowns, if these operations have consequences on stability of the appliance in order to avoid overturning, falling or uncontrolled movements of the appliance or of its component parts		N/A
	- on how to maintain adequate mechanical stability when in use, during transportation, assembly, dismantling, scrapping and any other action involving the appliance		N/A
	- on the protective measures to be taken by the user, including, where appropriate, the personal protective equipment to be provided		N/A
	- on the operating method to be followed in the event of accident or breakdown; if a blockage is likely to occur the operating method to safely unblock the appliance		N/A
	- on the specifications on the spare parts to be used, when these affect the health and safety of the operator		N/A
	- on airborne noise emissions, determined and declared in accordance with the Annex ZAB, which includes: (EN 60335-2-40/A13)		—
	- the A-weighted emission sound pressure level at workstations, where this exceeds 70 dB(A) ; (EN 60335-2-40/A13)		N/A
	- where this level does not exceed 70 dB(A), no value needs to be given, but the instructions shall state that the A-weighted sound pressure level is below 70 dB. (EN 60335-2-40/A13)		N/A
	- the peak C-weighted instantaneous sound pressure value at workstations, where this exceeds 63 Pa (130 dB in relation to 20 µPa) :		N/A
	- the A-weighted sound power level emitted by the machinery, where the A-weighted emission sound pressure level at workstations exceeds 80 dB(A) :		N/A
7.12.ZE2	The instructions includes a warning to disconnect the appliance from its power source during service and when replacing parts		N/A
	If the removal of the plug is foreseen, it is clearly indicated that the removal of the plug has to be such that an operator can check from any of the points to which he has access that the plug remains removed		N/A

IEC 60335-2-40			
Clause	Requirement + Test	Result - Remark	Verdict
	If this is not possible, due to the construction of the appliance or its installation, a disconnection with a locking system in the isolated position is provided		N/A
19.11.4.8	The appliance continues to operate, without causing any hazard to the user, from the same point in its operating cycle at which the voltage fluctuation occurred, or		N/A
	a manual operation is required to restart it		N/A
20.1	Appliances and their components and fittings have adequate mechanical stability during transportation, assembly, dismantling and any other action involving the appliance		N/A
20.2	Dangerous moving transmission parts safeguarded either by design or guards		N/A
	When guards are used, they are fixed guards, interlocking movable guards or protective devices		N/A
	Moving parts directly involved in the function of the appliance which cannot be made completely inaccessible fitted with:		—
	- fixed guards or interlocking movable guards preventing access to those sections of the parts that are not used in the work, and		N/A
	- adjustable guards restricting access to those sections of the moving parts where access is necessary		N/A
	Interlocking movable guards used where frequent access is required		N/A
21.1	Appliances and their components and fittings have adequate mechanical strength and is constructed to withstand such rough handling that may be expected in normal use, during transportation, assembly, dismantling, scrapping and any other action involving the appliance		N/A
22.ZE.1	For appliances provided with a seat, the seat gives adequate stability		N/A
	The distance between the seat and the control devices capable of being adapted to the operator		N/A
22.ZE.2	For appliances provided with separate devices for the start and the stop functions, the stop function is unambiguously identifiable and does always override the start function		N/A
	For appliances provided with one device performing the start and the stop function, the stop function is unambiguously identifiable and does always override the start function		N/A

IEC 60335-2-40			
Clause	Requirement + Test	Result - Remark	Verdict
22.ZE.3	Appliances designed in such a way that incorrect mounting is avoided, if this can lead to an unsafe situation		N/A
	If this is not possible, information on the correct mounting is given directly on the part and/or the enclosure		N/A
22.ZE.4	Where the weight, size or shape prevents appliances from being moved manually, they are fitted with attachments for lifting gear, or		N/A
	so designed that they can be fitted with such attachments, or		N/A
	be shaped in such a way that standard lifting gear can easily be used		N/A
	Appliances to be moved manually are constructed or equipped so that they can be moved easily and safely		N/A
22.ZE.5	The fixing systems of fixed guards which prevent access to dangerous moving transmission parts only removable with the use of tools		N/A
	If such guards have to be removed by the user for routine cleaning or maintenance their fixing systems remain attached to the fixed guards or to the machine after removal		N/A
	Where possible, guards are incapable of remaining in place without their fixings		N/A
	This does not apply if, after removal of the screws, or if the component is incorrectly repositioned, the appliance becomes inoperative		N/A
	Movable guards are interlocked		N/A
	The interlocking devices prevent the start of hazardous appliance functions until the guards are fixed in their position, and give a stop command whenever they are no longer closed		N/A
	Where it is possible for an operator to reach the danger zone before the risk due to hazardous appliance functions has ceased, movable guards associated with a guard locking device in addition to an interlocking device that:		—
	- prevents the start of hazardous appliance functions until the guard is closed and locked, and		N/A
	- keeps the guard closed and locked until the risk of injury from the hazardous appliance functions has ceased		N/A
	Interlocking movable guards remain attached to the appliance when open, and		N/A
	they are designed and constructed in such a way that they can be adjusted only by means of an intentional action		N/A

IEC 60335-2-40			
Clause	Requirement + Test	Result - Remark	Verdict
22.ZE.6	Interlocking movable guards designed in such a way that the absence or failure of one of their components prevents starting or stops the hazardous appliance functions		N/A
	The guard is opened at the extent needed to cause the interlocking to operate and is then closed. This operation is carried out for 5 000 cycles at a rate of 5 cycles per min. (EN 60335-2-40/A13/AC)		N/A
	After this test any defect that may be expected in normal use is applied to the interlock system, including interruption of the supply, only one defect being simulated at a time		N/A
	After these tests the interlock system is fit for further use		N/A
22.ZE.7	Adjustable guards restricting access to areas of the moving parts strictly necessary for the work are:		—
	- adjustable manually or automatically, depending on the type of work involved, and		N/A
	- readily adjustable without the use of tools		N/A
22.ZE.8	In case of interruption, re-establishment after an interruption or fluctuation in whatever manner of the power supply, the appliance does not restart		N/A
	However, automatic restarting of the operation is allowed if the appliance may continue to operate, without causing any hazard to the user, from the same point in its operating cycle at which the voltage interruption or fluctuation occurred		N/A
22.ZE.9	Appliances fitted with means to isolate them from all energy sources		N/A
	Such isolators are clearly identified, and		N/A
	they are capable of being locked if reconnection endanger persons		N/A
	After the energy source is disconnected, it is possible to dissipate any energy remaining or stored in the circuits of the appliance without risk to persons		N/A
ZF	ANNEX ZF (INFORMATIVE) CRITERIA APPLIED FOR THE ALLOCATION OF PRODUCTS COVERED BY STANDARDS IN THE EN 60335 SERIES UNDER LVD OR MD		—
	List of standards under CENELEC/TC61 with the allocation under the LVD (Low Voltage Directive) or the MD (Machinery Directive) :	LVD	P

IEC 60335-2-40			
Clause	Requirement + Test	Result - Remark	Verdict
ZG	ANNEX ZG (NORMATIVE) UV APPLIANCES		—
	The following modifications to this standard apply to appliances having UV emitters		N/A
	This annex is not applicable to appliances covered by the scopes of IEC 60335-2-27, IEC 60335-2-59 or IEC 60335-2-109		N/A
7.12.ZG	The instructions for appliances incorporating UVC emitters include the substance of the following: WARNING — This appliance contains a UV emitter. Do not stare at the light source		N/A
32	For appliances incorporating UV emitters the manufacturer delivers a declaration providing evidence that the plastic material exposed to the radiation is UV resistant		N/A
ZZ	ANNEX ZZ (INFORMATIVE) COVERAGE OF ESSENTIAL REQUIREMENTS OF EC DIRECTIVES		—
	Description of the relation between this European standard and the LVD (Low Voltage Directive, 2006/95/EC) and the MD (Machinery Directive, 2006/42/EC)		P
ZAA	ANNEX ZAA (INFORMATIVE) (EN 60335-2-40/A11) THE RELEVANCE OF THE PRESSURE EQUIPMENT DIRECTIVE		—
	Refrigerating systems having a pressure greater than 0,05 MPa are considered to be assemblies falling within the scope of the Pressure Equipment Directive, 97/23/EC. However, according to Article 1, item 3.6 of the directive, equipment classified no higher than category I and covered by the low voltage directive is excluded from its scope. (EN 60335-2-40/A11)		N/A
	According to guideline 1/39 of the directive, this exclusion applies to both components and assemblies (refrigerant circuits). This applies to appliances containing vessels (e.g. compressors, receivers) or piping with limits in accordance with the following (EN 60335-2-40/A11):		N/A
	Vessels (EN 60335-2-40/A11)		—
	- dangerous refrigerants (Annex II, Table 1) (EN 60335-2-40/A11):		—
	- volume not exceeding 1 l, or (EN 60335-2-40/A11)		N/A
	- pressure x volume not exceeding 5 MPa l (EN 60335-2-40/A11)		N/A
	- non-dangerous refrigerants (Annex II, Table 2) (EN 60335-2-40/A11):		—

IEC 60335-2-40			
Clause	Requirement + Test	Result - Remark	Verdict
	- volume not exceeding 1 l, or (EN 60335-2-40/A11)		N/A
	- pressure x volume not exceeding 20 MPa l (EN 60335-2-40/A11)		N/A
	Piping (EN 60335-2-40/A11)		—
	- dangerous refrigerants (Annex II, Table 6) (EN 60335-2-40/A11):		—
	- numerical designation not exceeding 25, or (EN 60335-2-40/A11)		N/A
	- pressure not exceeding 1 MPa and numerical designation not exceeding 100, or (EN 60335-2-40/A11)		N/A
	- pressure exceeding 1 MPa and pressure x numerical designation not exceeding 100 MPa (EN 60335-2-40/A11).		N/A
	- non-dangerous refrigerants (Annex II, Table 7) (EN 60335-2-40/A11):		—
	- numerical designation not exceeding 100, or (EN 60335-2-40/A11)		N/A
	- pressure x numerical designation not exceeding 350 MPa (EN 60335-2-40/A11).		N/A
	For other components, the most onerous limit of the two applies (EN 60335-2-40/A11)		N/A
	The volume is the internal volume of the vessel and includes the volume of pipework up to the first connection. It excludes the volume of fixed internal parts (EN 60335-2-40/A11)		N/A
	The pressure is the maximum pressure the vessel or piping system is exposed to, as specified by the manufacturer of the appliance (EN 60335-2-40/A11)		N/A
	The numerical designation designates the size common to all components in the piping system (EN 60335-2-40/A11)		N/A
	If any component exceeds the limits given above, the appliance has to comply with the directive. The technical requirements are given in Annex I and the conformity assessment tables and procedures in Annexes II and III of the directive (EN 60335-2-40/A11)		N/A
	Commonly used dangerous refrigerants, identified as Group 1 in the directive, are listed in table ZAA.1 (EN 60335-2-40/A11)		N/A
	Commonly used non-dangerous refrigerants, identified as Group 2 in the directive, are listed in table ZAA.2 (EN 60335-2-40/A11)		N/A

IEC 60335-2-40			
Clause	Requirement + Test	Result - Remark	Verdict
ZAB	ANNEX ZAA (NORMATIVE) (EN 60335-2-40/A13) EMISSION OF ACOUSTICAL NOISE FROM APPLIANCES COVERED BY ANNEX ZE		—
ZAB.1	Noise reduction is an integral part of the design process and achieved by particularly applying measures at source to control noise, see for example EN ISO 11688-1. (EN 60335-2-40/A13)		N/A
	Success of the applied noise reduction measures is assessed on the basis of the actual noise emission values in relation to other machines of the same type with comparable non-acoustical technical data. (EN 60335-2-40/A13)		N/A
ZAB.2.1	A-weighted emission sound pressure level determined in accordance with EN 11203:2009, 6.2.3 d) with the surface S being the measurement surface used for the sound power level determination. (EN 60335-2-40/A13)		N/A
	If the sound power level determination is based on a measurement method requiring a reverberant sound field, the surface S to define Q, shall be a parallelepiped measurement surface at a distance of 1 m from the reference box enclosing the source and assuming only one reflecting surface. (EN 60335-2-40/A13)		N/A
ZAB.2.2	A-weighted sound power level determined in accordance with EN 12102 applying a measurement method of at least grade 2. (EN 60335-2-40/A13)		N/A
	If a grade 3 measurement method used for determining the A-weighted sound power level, the reasons are explicitly mentioned (EN 60335-2-40/A13)		N/A
ZAB.2.3	Total measurement uncertainty is depending on the standard deviation of reproducibility σ_{R0} of the measurement method and the standard deviation σ_{omc} representing the instability of the operating and mounting conditions. (EN 60335-2-40/A13)		N/A
	σ_{R0} has an upper value for a grade 2 measurement method of about 1,5 dB, whereas σ_{omc} may have values between 0,5 dB for small variations of the sound power due on the mounting and operating conditions or 4 dB for very instable sources (EN 60335-2-40/A13)		N/A
	Total measurement uncertainty for the A-weighted emission sound pressure level is of the same order as the one for the respective sound power level measurement. (EN 60335-2-40/A13)		N/A
ZAB.2.4	Information to be recorded covers all the technical requirements of this noise test code. (EN 60335-2-40/A13)		N/A

IEC 60335-2-40			
Clause	Requirement + Test	Result - Remark	Verdict
	Any deviations from this noise test code or from the basic standards upon which it is based are to be recorded together with the technical justification for such deviations. (EN 60335-2-40/A13)		N/A
ZAB.2.5	Information to be given in the test report includes : (EN 60335-2-40/A13)		N/A
	- the data required by the manufacturer for inclusion in the noise declaration,. (EN 60335-2-40/A13)		N/A
	- the data required by the user to verify the declared values. (EN 60335-2-40/A13)		N/A
	Thus the following information shall be included.. : (EN 60335-2-40/A13)		N/A
	- reference to the noise test code and the basic noise emission standards used; (EN 60335-2-40/A13)		N/A
	- description of the installation and operation conditions used; (EN 60335-2-40/A13)		N/A
	- location of the work station(s) and other specified positions; (EN 60335-2-40/A13)		N/A
	- the noise emission values obtained (EN 60335-2-40/A13)		N/A
	Test report states that all requirements of the noise test code have been fulfilled, or, if this is not the case, it shall identify any unfulfilled requirements. (EN 60335-2-40/A13)		N/A
	Deviations from the requirements stated and a technical justification for these deviations shall be given. (EN 60335-2-40/A13)		N/A
ZAB.2.6	Noise emission declaration is made according to EN ISO 4871 (EN 60335-2-40/A13)		N/A
	Emission sound pressure level L_{pA} is made as a dual number noise emission declaration, thus declaring the determined value for L_{pA} and the respective uncertainty K_{pA} . (EN 60335-2-40/A13)		N/A
	Sound power level L_{WA} is declared as single number noise emission declaration declaring the sum of the measured sound power level and its uncertainty K_{WA} . (EN 60335-2-40/A13)		N/A
	Noise declaration states that the noise emission values have been obtained according to this noise test code. (EN 60335-2-40/A13)		N/A
	Any deviations from this noise test code or from the basic standards upon which it is based are clearly indicated. (EN 60335-2-40/A13)		N/A
	Additional noise emission values are given in the declaration. (EN 60335-2-40/A13)		N/A

IEC 60335-2-40			
Clause	Requirement + Test	Result - Remark	Verdict
	If undertaken, verification of the noise emission values shall be conducted according to EN ISO 4871, using the same mounting and operating conditions as those used for the initial determination. (EN 60335-2-40/A13)		N/A

ATTACHMENT 2: Amendment 13 of EN 60335-1 (EN 60335-1:2012/A13:2017)			
ZZA	Annex ZZA Relationship between this European Standard and the safety objectives of Directive 2014/35/EU [2014 OJ L96] aimed to be covered		—
ZZA.1	Table ZZA.1 – Correspondence between this European Standard and Annex I of Directive 2014/35/EU [2014 OJ L96]		P
ZZB	Relationship between this European Standard and the essential requirements of Directive 2006/42/EC aimed to be covered		—
ZZB.1	Table ZZB.1 – Correspondence between this European Standard and Annex I of Directive 2006/42/EC [OJ No L 157]		P
ATTACHMENT 3: AC:2013 of EN 60335-2-40:2003			
Annex ZE	—		—
7.12.Z1	Replace the reference to 7.12.Z1 by 7.12.ZE1.		—
7.12.ZE1	Replace “dashed item” by “bulleted item”.		—
22.ZE.5	Delete the replacement.		—
22.ZE.6	Replace the third paragraph beginning with “The guard is opened...” by: The guard is opened at the extent needed to cause the interlocking to operate and is then closed. This operation is carried out for 5 000 cycles at a rate of 5 cycles per min.		N/A



Picture No.1: Overall front view of outdoor unit model: RAS-10J2AVRG-E



Picture No.2: Overall rear view of outdoor unit model: RAS-10J2AVRG-E



Picture No.3: Service port and marking of outdoor unit model: RAS-10J2AVRG-E



Picture No.4: Inner view of outdoor unit model: RAS-10J2AVRG-E



Picture No. 5: Inner side view of outdoor unit model: RAS-10J2AVRG-E



Picture No.6: Terminal of outdoor unit model: RAS-10J2AVRG-E



Picture No.7: Compressor compartment of outdoor unit model: RAS-10J2AVRG-E



Picture No.8: Overall front view of outdoor unit model: RAS-16J2AVRG-E



Picture No.9: Overall rear view of outdoor unit model: RAS-16J2AVRG-E



Picture No.10: Service port and marking of outdoor unit model: RAS-16J2AVRG-E



Picture No 11: Inner view of outdoor unit model: RAS-16J2AVRG-E



Picture No. 12: Inner side view of outdoor unit model: RAS-16J2AVRG-E



Picture No.13: Terminal of outdoor unit model: RAS-16J2AVRG-E



Picture No.14: Compressor compartment of outdoor unit model: RAS-16J2AVRG-E



Picture No.15: Overall front view of outdoor unit model: RAS-22J2AVRG-E



Picture No.16: Overall rear view of outdoor unit model: RAS-22J2AVRG-E



Picture No.17: Service port and marking of outdoor unit model: RAS-22J2AVRG-E

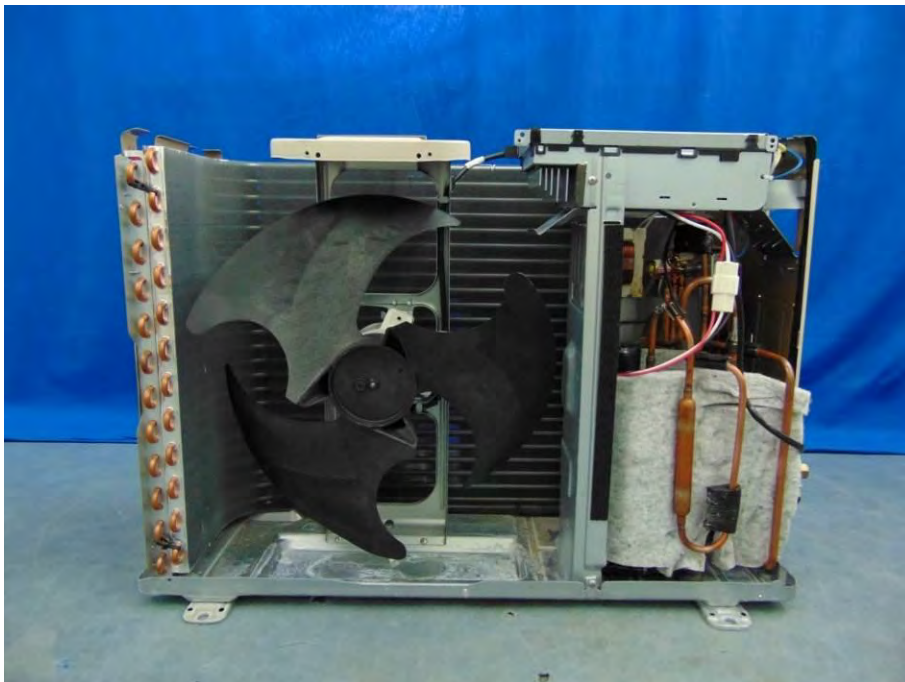

Picture No.18: Inner view of outdoor unit model: RAS-22J2AVRG-E



Picture No. 19: Inner side view of outdoor unit model: RAS-22J2AVRG-E



Picture No.20: Terminal of outdoor unit model: RAS-22J2AVRG-E



Picture No.21: Compressor compartment of outdoor unit model: RAS-22J2AVRG-E



Picture No.22: Overall front view of outdoor unit model: RAS-24J2AVRG-E



Picture No.23: Inner view of outdoor unit model: RAS-24J2AVRG-E

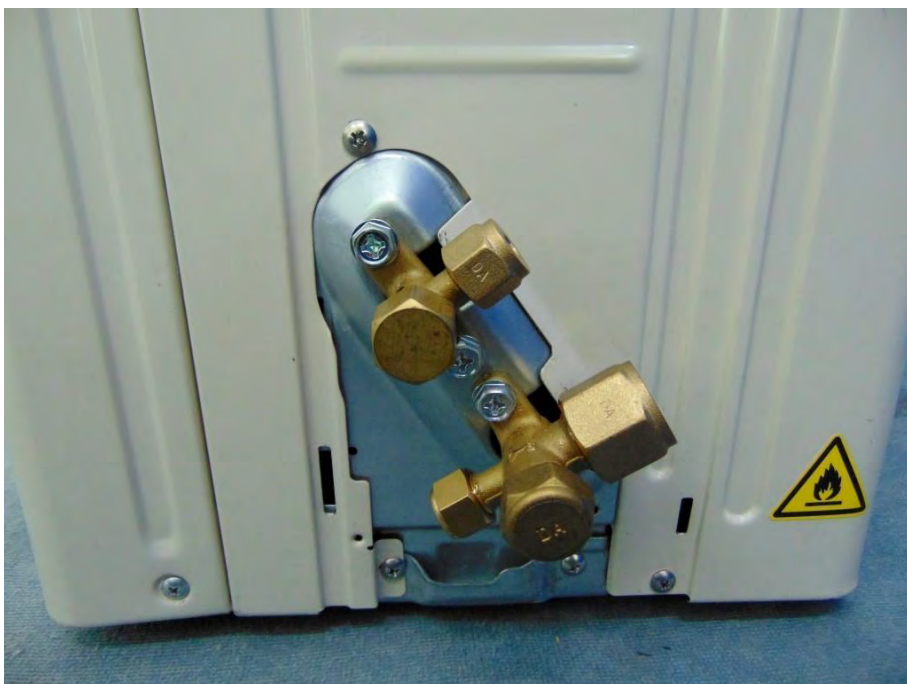

Picture No.24: Inner view of outdoor unit model: RAS-24J2AVRG-E

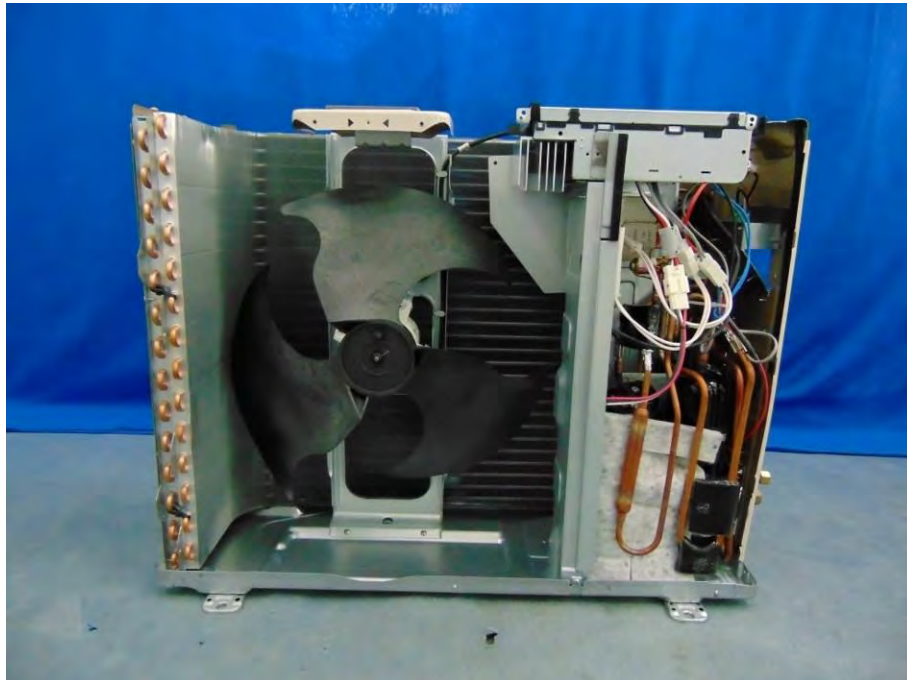

Picture No.25: Inner view of outdoor unit model: RAS-24J2AVRG-E



Picture No. 26: Inner side view of outdoor unit model: RAS-24J2AVRG-E



Picture No.27: Terminal of outdoor unit model: RAS-24J2AVRG-E

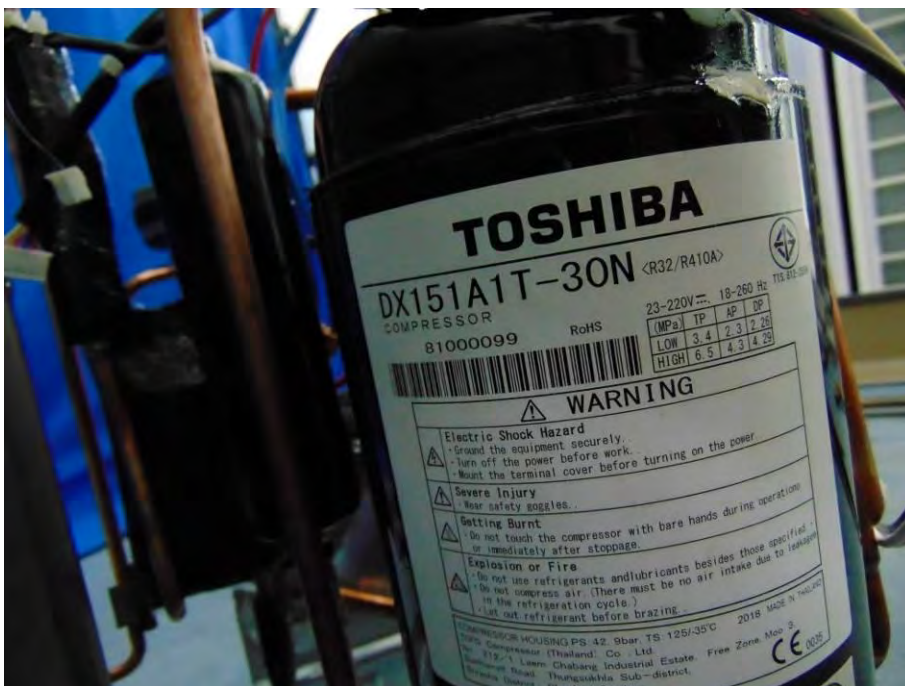

Picture No.28: Compressor compartment of outdoor unit model: RAS-24J2AVRG-E



Picture No.29: Overall front view of outdoor unit model: RAS-24PAVSG-EE



Picture No.30: Overall rear view of outdoor unit model: RAS-24PAVSG-EE



Picture No.31: Service port and marking of outdoor unit model: RAS-24PAVSG-EE

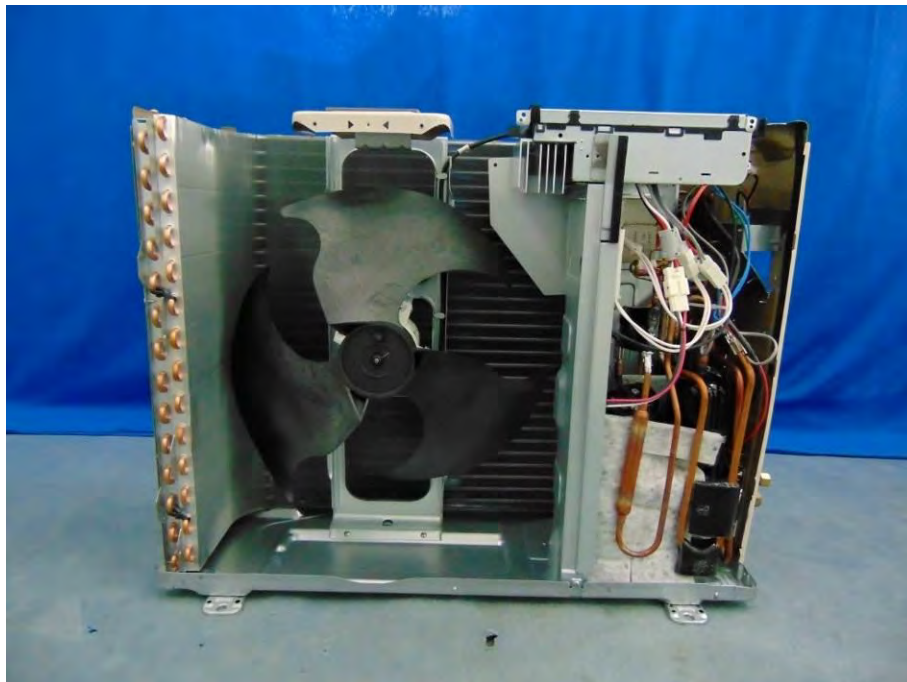

Picture No.32: Inner view of outdoor unit model: RAS-24PAVSG-EE



Picture No. 33: Inner side view of outdoor unit model: RAS-24PAVSG-EE



Picture No.34: Terminal of outdoor unit model: RAS-24PAVSG-EE



Picture No.35: Compressor compartment of outdoor unit model: RAS-24PAVSG-EE



Picture No.36: Overall front view of indoor unit model: RAS-B10J2KVRG-E



Picture No.37: Overall view of indoor unit model: RAS-B10J2KVRG-E

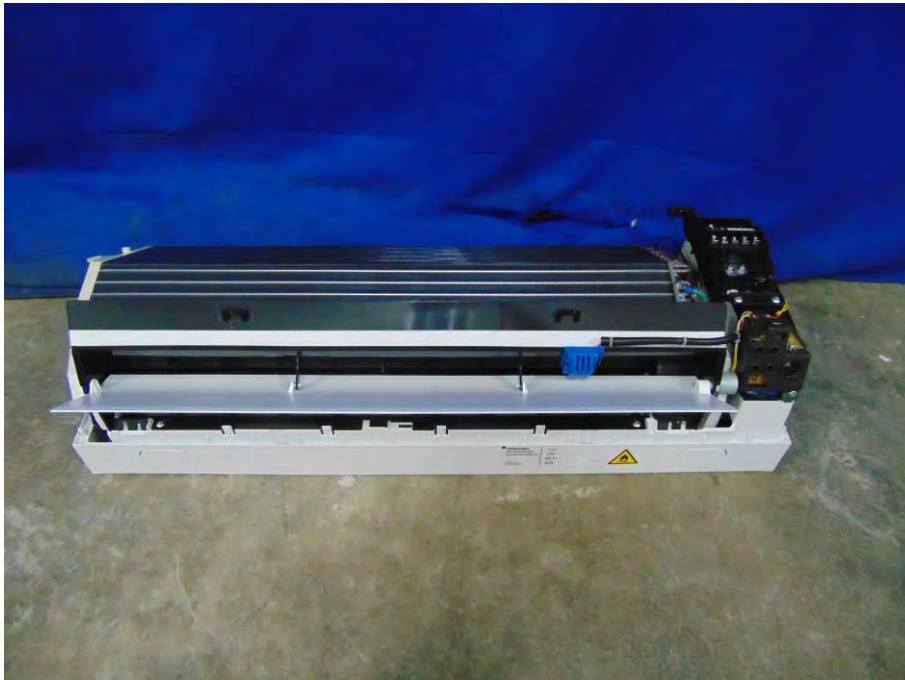

Picture No.38: Overall inner view of indoor unit model: RAS-B10J2KVRG-E



Picture No.39: Overall inner view of indoor unit model: RAS-B10J2KVRG-E



Picture No.40: Terminal view of indoor unit model: RAS-B10J2KVRG-E

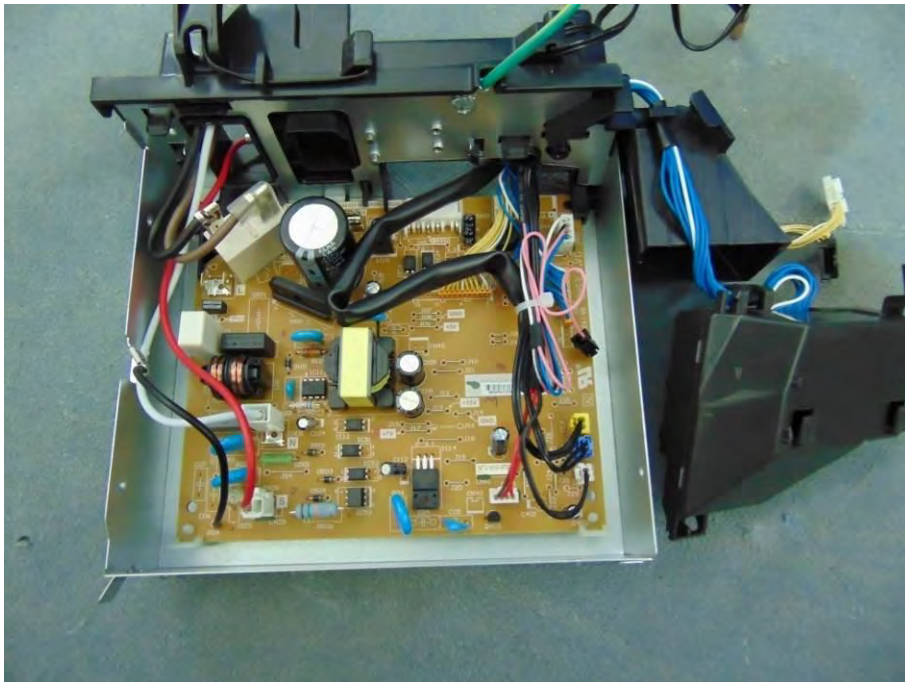

Picture No.41: PCB. compartment of indoor unit: RAS-B10J2KVRG-E



Picture No.42: Overall front view of indoor unit model: RAS-B16J2KVRG-E



Picture No.43: Overall view of indoor unit model: RAS-B16J2KVRG-E

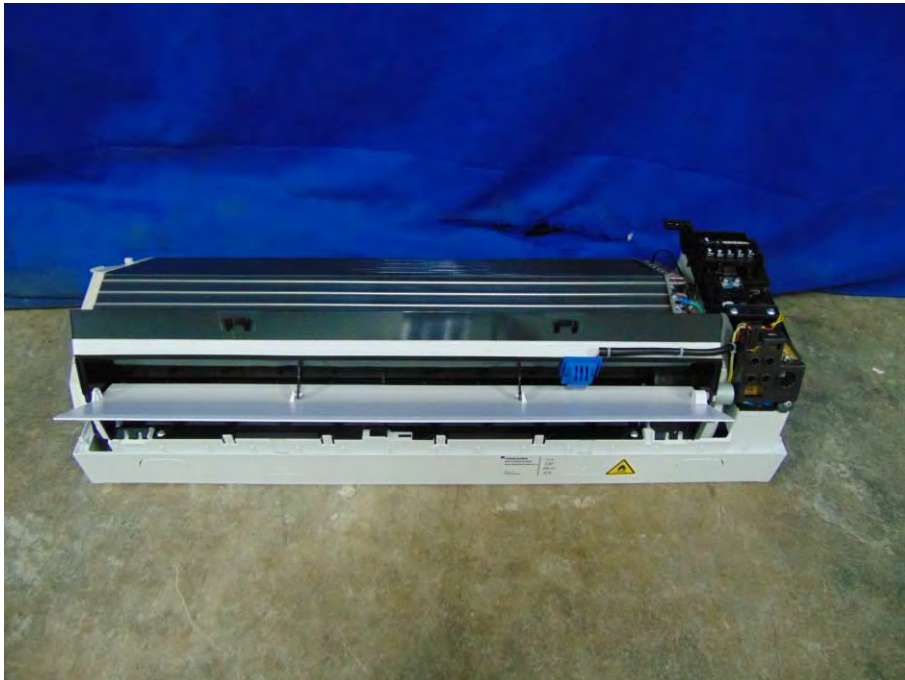

Picture No.44: Overall inner view of indoor unit model: RAS-B16J2KVRG-E



Picture No.45: Overall inner view of indoor unit model: RAS-B16J2KVRG-E



Picture No.46: Terminal view of indoor unit model: RAS-B16J2KVRG-E

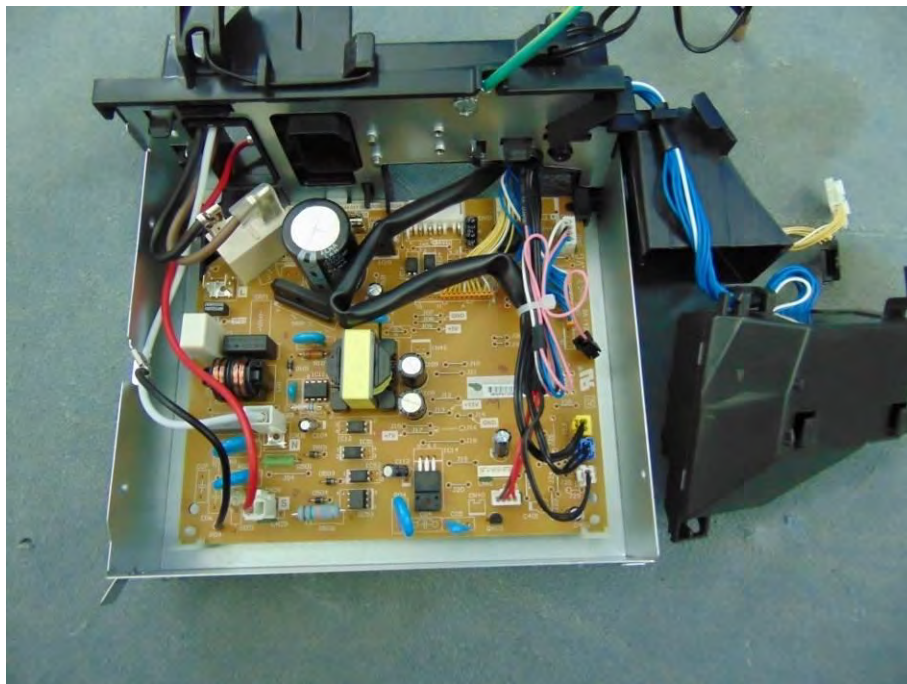

Picture No.47: PCB. compartment of indoor unit: RAS-B16J2KVRG-E



Picture No.48: Overall front view of indoor unit model: RAS-B22J2KVRG-E



Picture No.49: Overall view of indoor unit model: RAS-B22J2KVRG-E

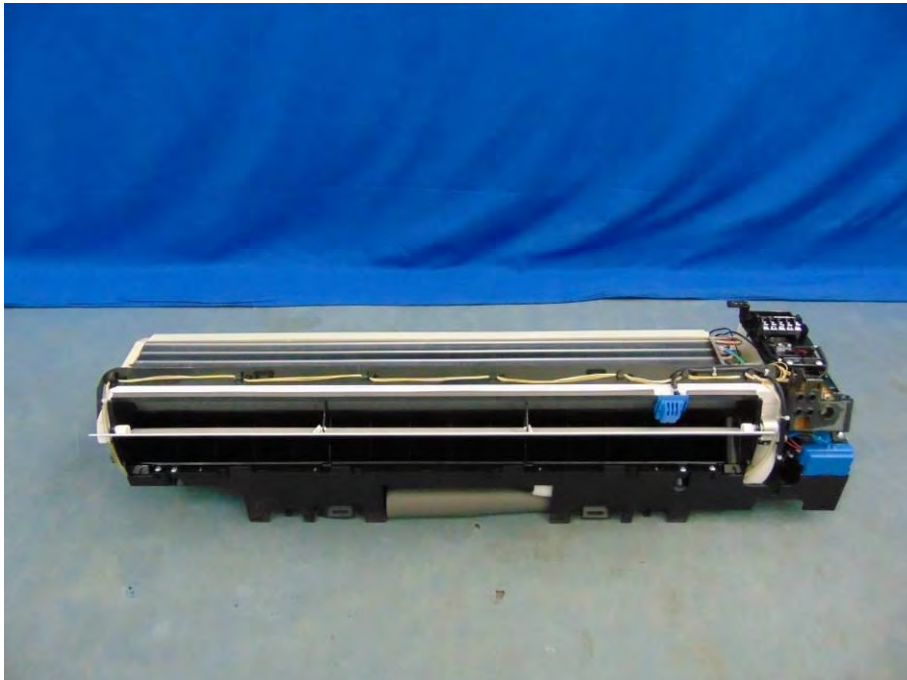

Picture No.50: Overall inner view of indoor unit model: RAS-B22J2KVRG-E



Picture No.51: Overall inner view of indoor unit model: RAS-B22J2KVRG-E

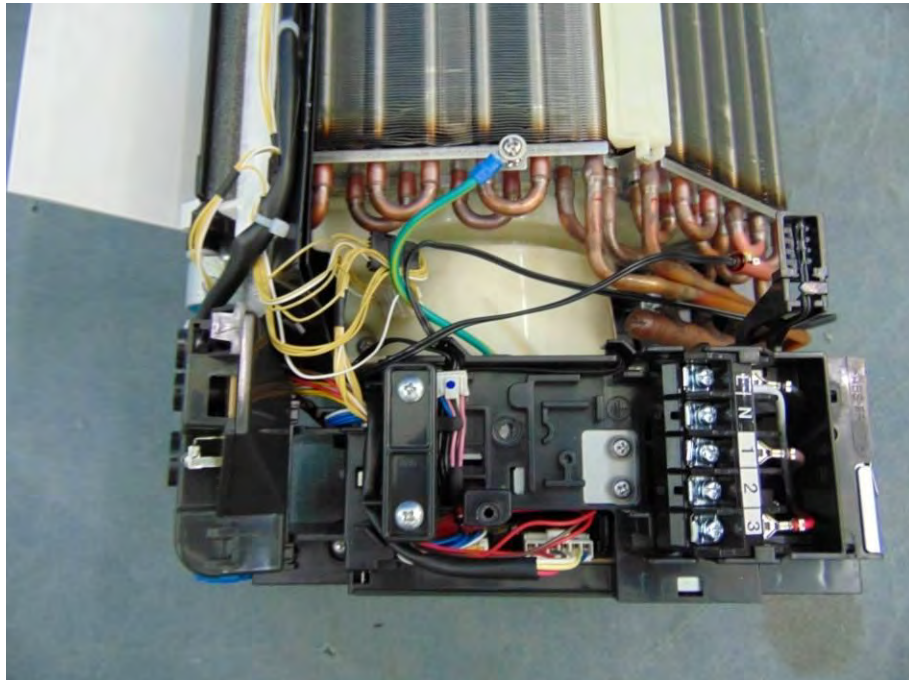

Picture No.52: Terminal view of indoor unit model: RAS-B22J2KVRG-E

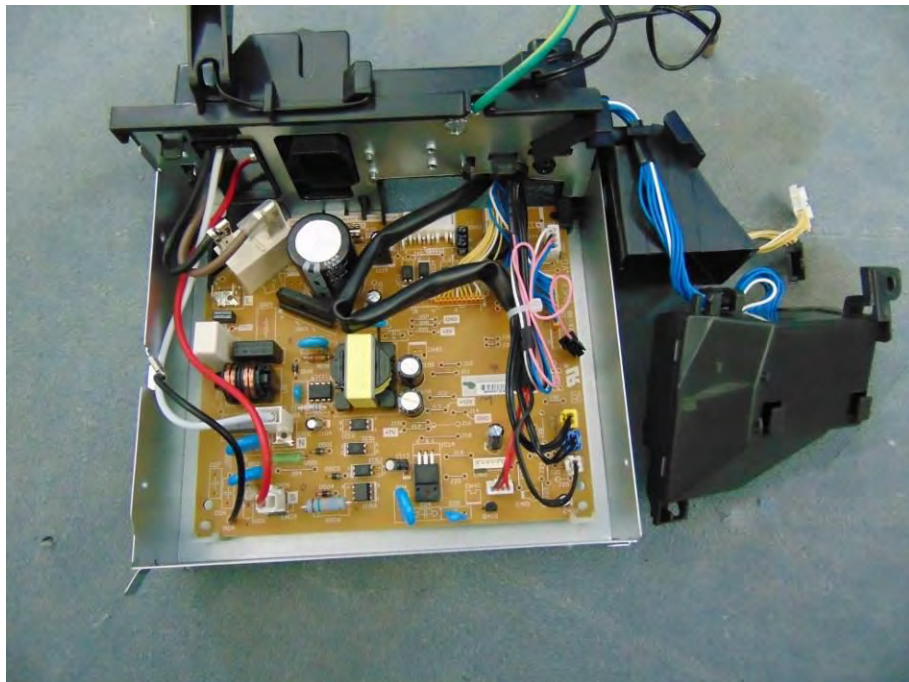

Picture No.53: PCB. compartment of indoor unit: RAS-B22J2KVRG-E



Picture No.54: Overall front view of indoor unit model: RAS-B24J2KVRG-E

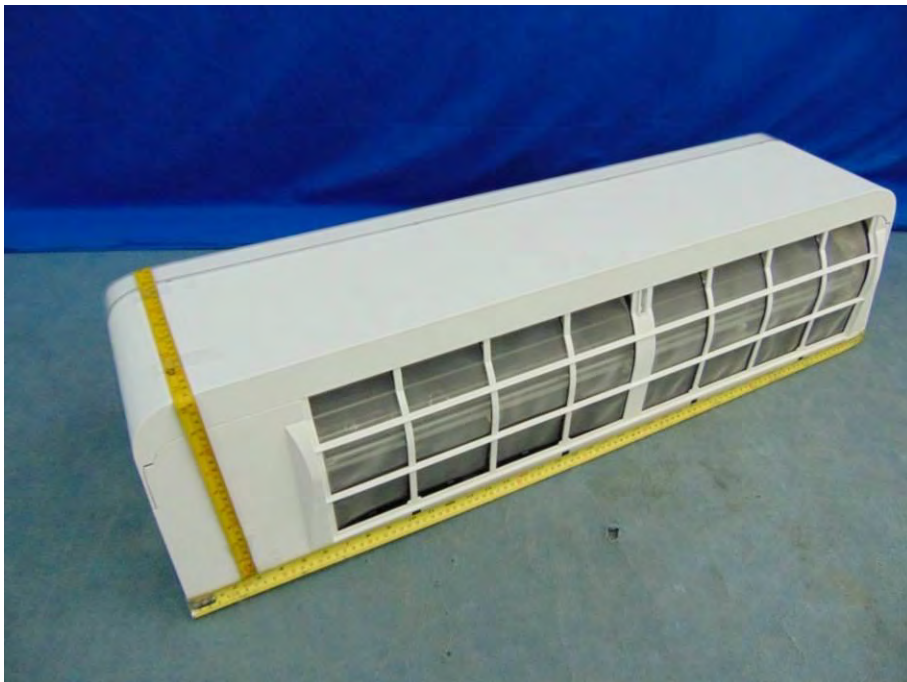

Picture No.55: Overall view of indoor unit model: RAS-B24J2KVRG-E

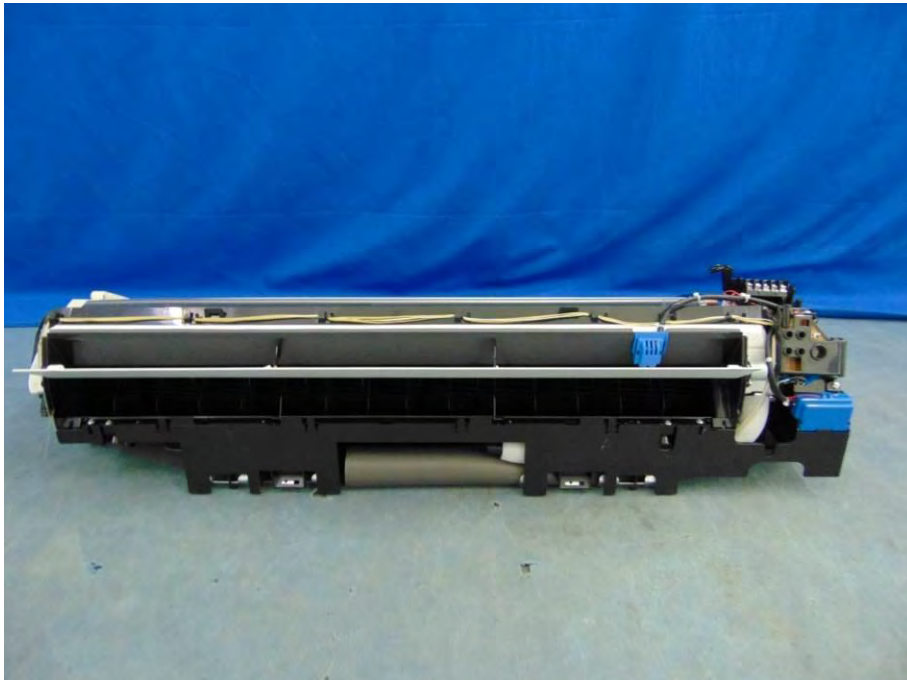

Picture No.56: Overall inner view of indoor unit model: RAS-B24J2KVRG-E



Picture No.57: Overall inner view of indoor unit model: RAS-B24J2KVRG-E

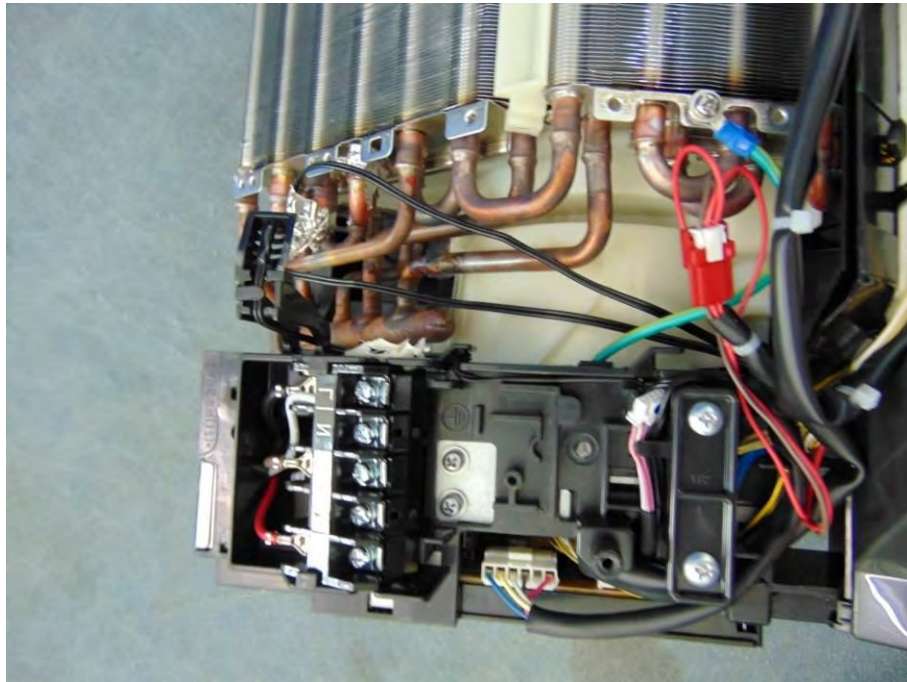

Picture No.58: Terminal view of indoor unit model: RAS-B24J2KVRG-E

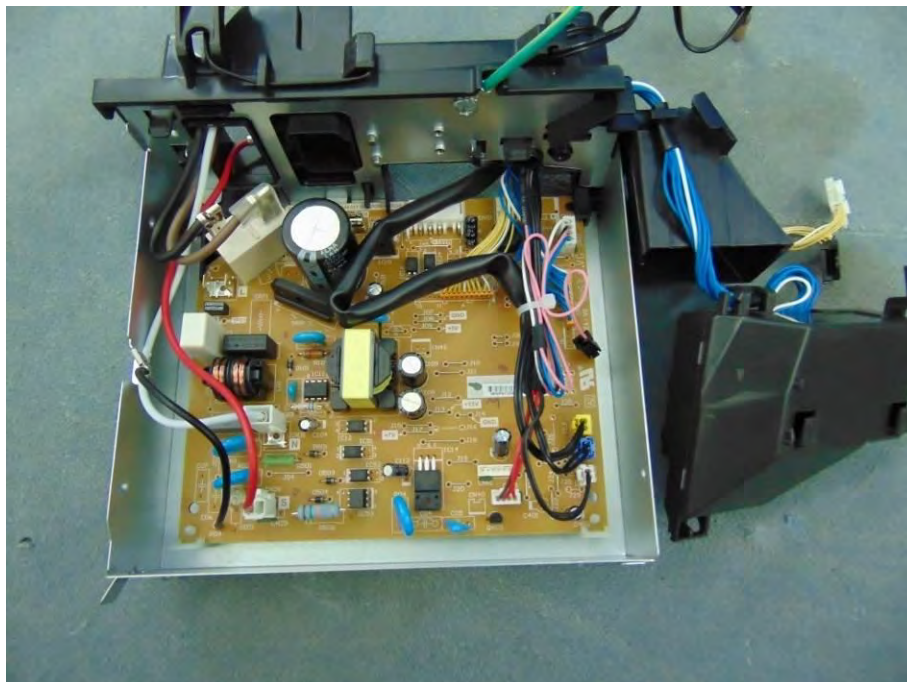

Picture No.59: PCB. compartment of indoor unit: RAS-B24J2KVRG-E



Picture No.60: Overall front view of indoor unit model: RAS-24PKVSG-EE



Picture No.61: Overall view of indoor unit model: RAS-24PKVSG-EE

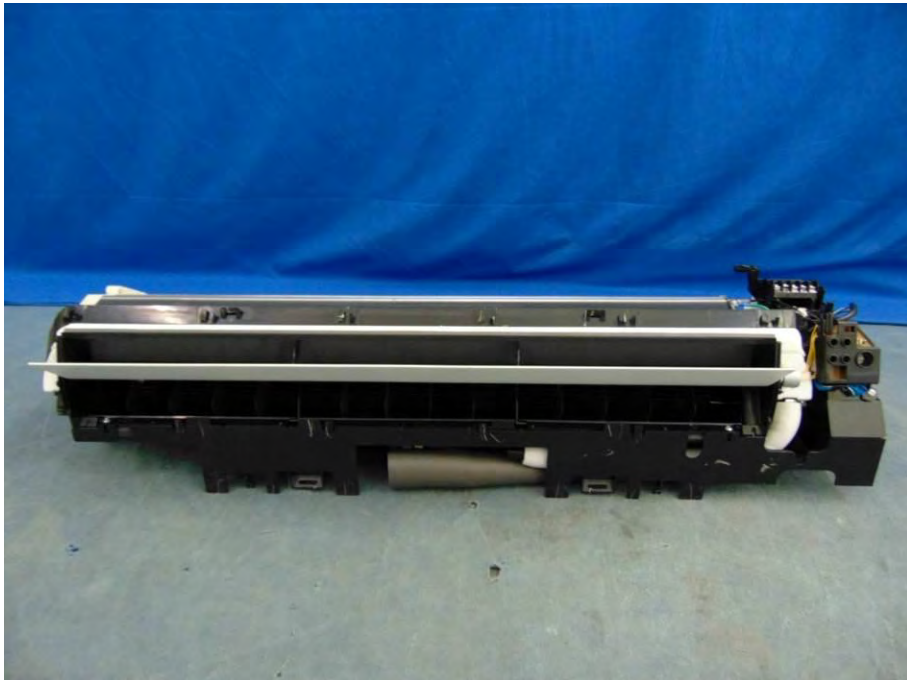

Picture No.62: Overall inner view of indoor unit model: RAS-24PKVSG-EE

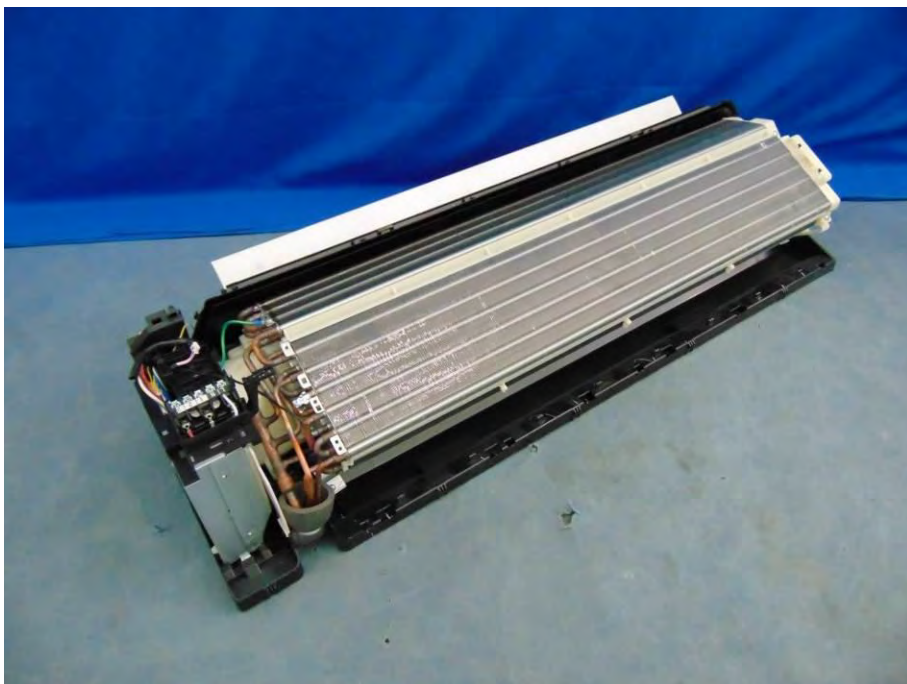

Picture No.63: Overall inner view of indoor unit model: RAS-24PKVSG-EE

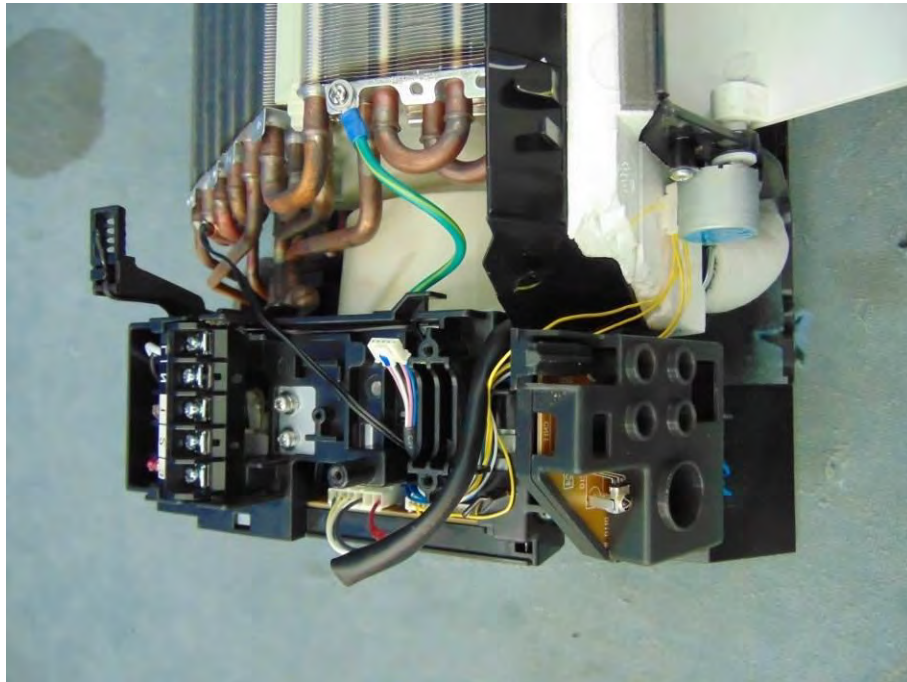

Picture No.64: Terminal view of indoor unit model: RAS-24PKVSG-EE

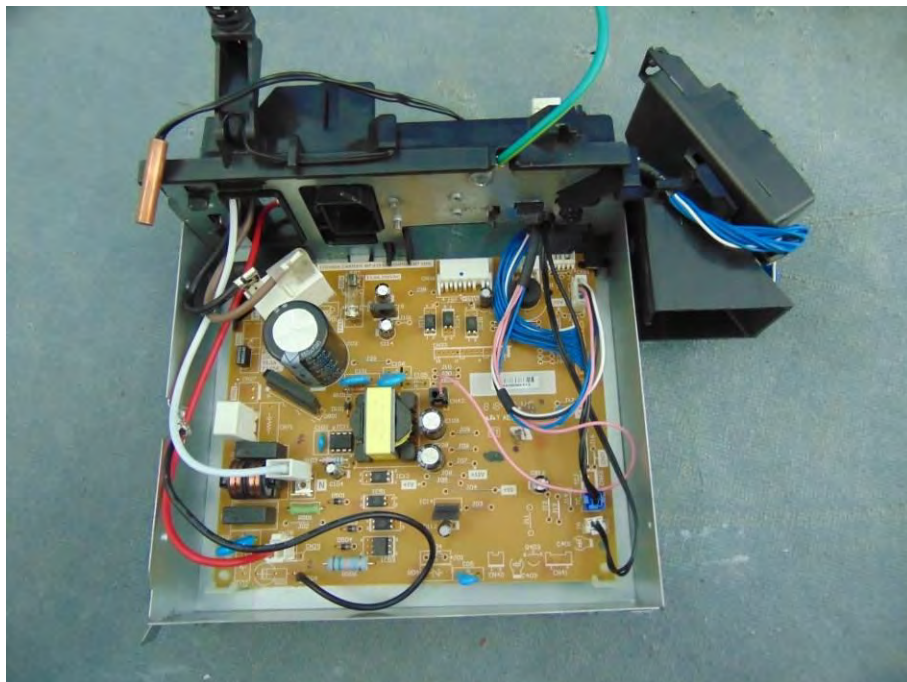

Picture No.65: PCB. compartment of indoor unit: RAS-24PKVSG-EE



Picture No.66: Component view of PCB model: WP-038

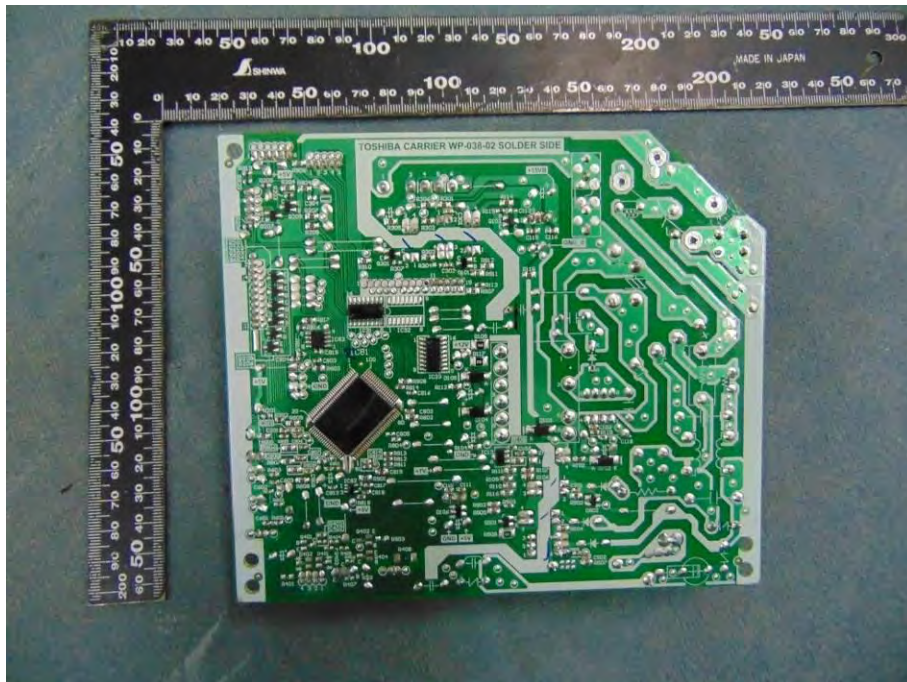

Picture No.67: Pattern view of PCB model: WP-038

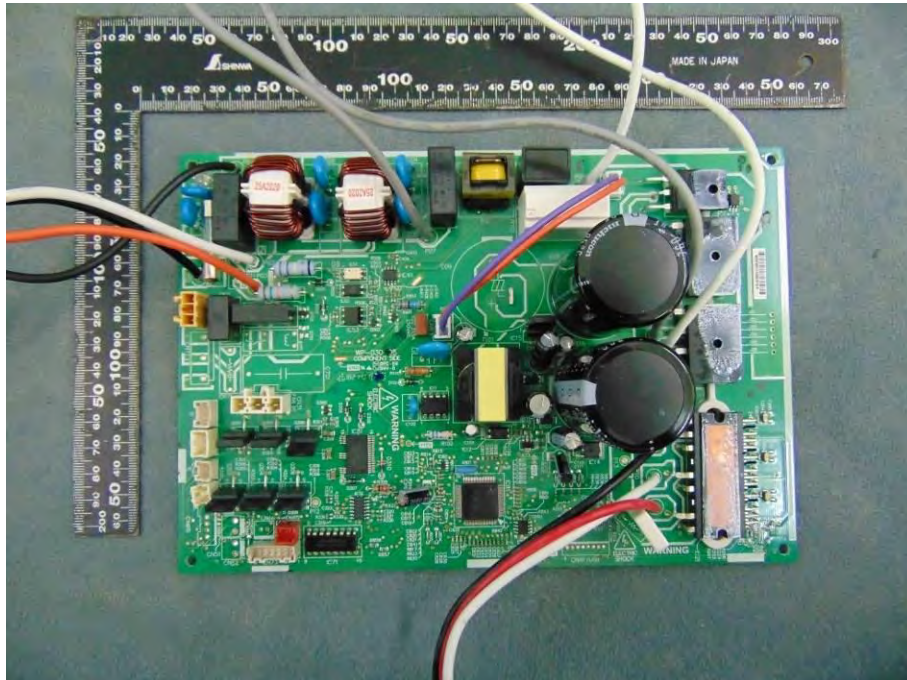

Picture No.68: Component view of PCB model: WP-030

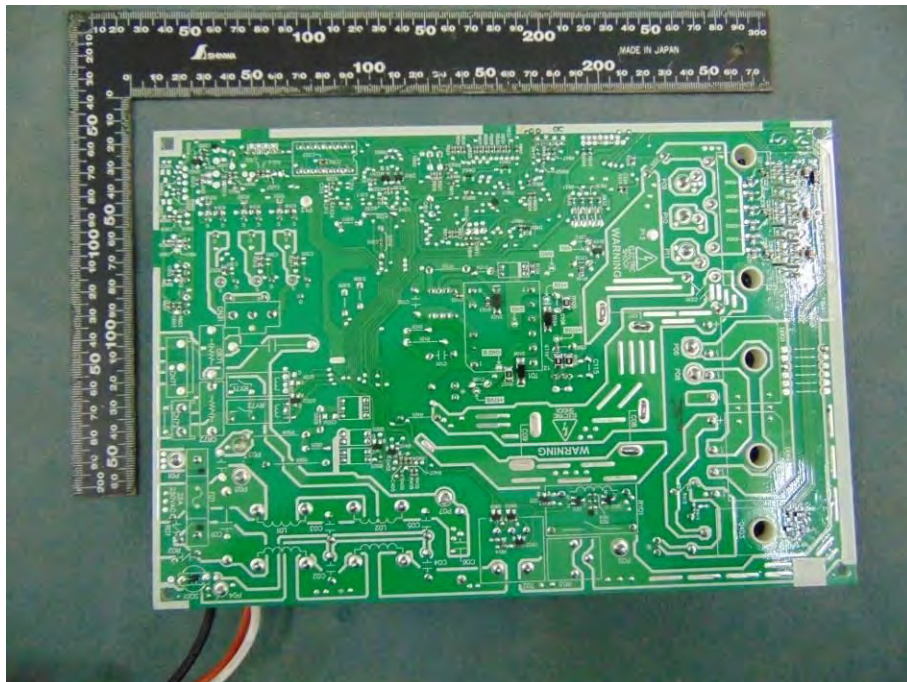

Picture No.69: Pattern view of PCB model: WP-030



Picture No.70: Component view of PCB model: WP-048

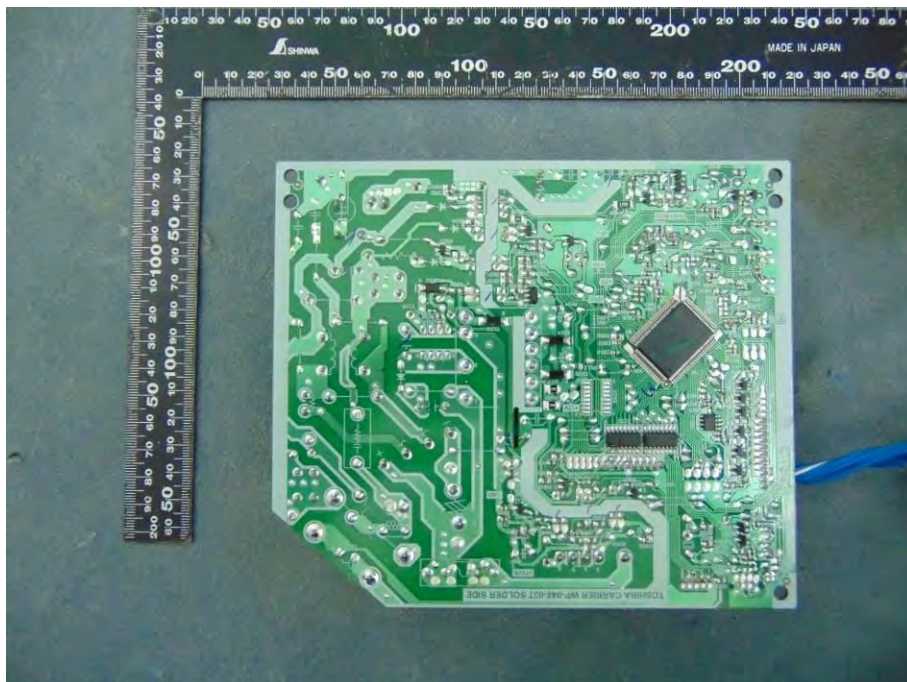

Picture No.71: Pattern view of PCB model: WP-048

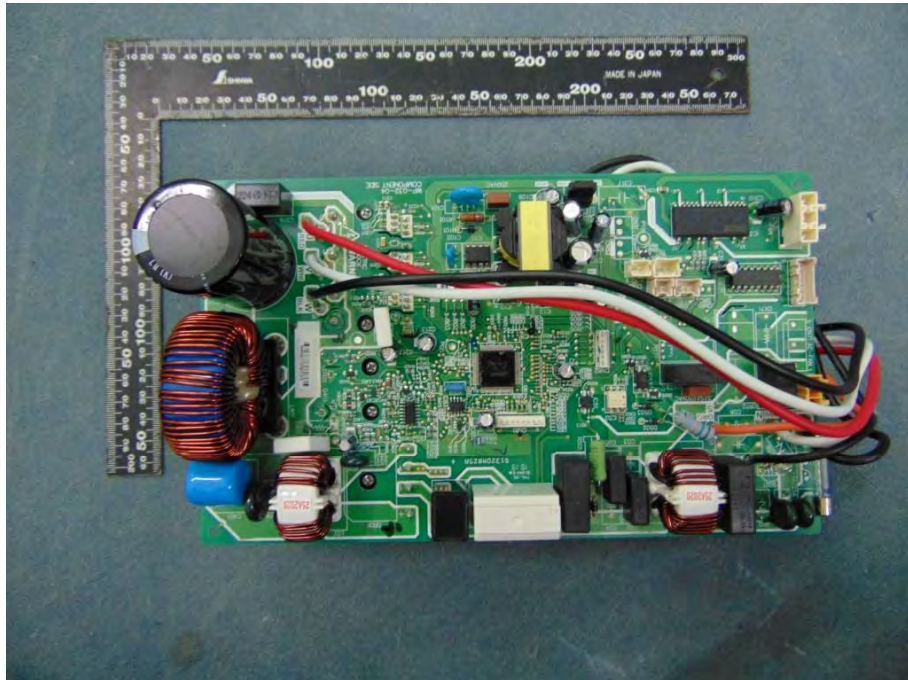

Picture No.72: Component view of PCB model: WP-048

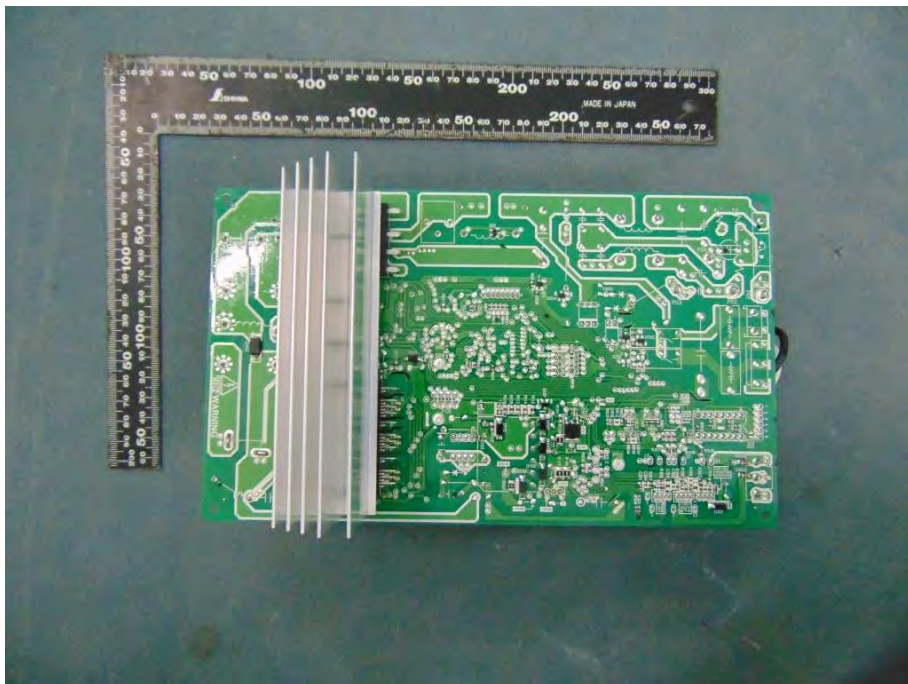

Picture No.73: Pattern view of PCB model: WP-048

***** End of Report *****